

NACHI

**Ball & Roller
Bearings**

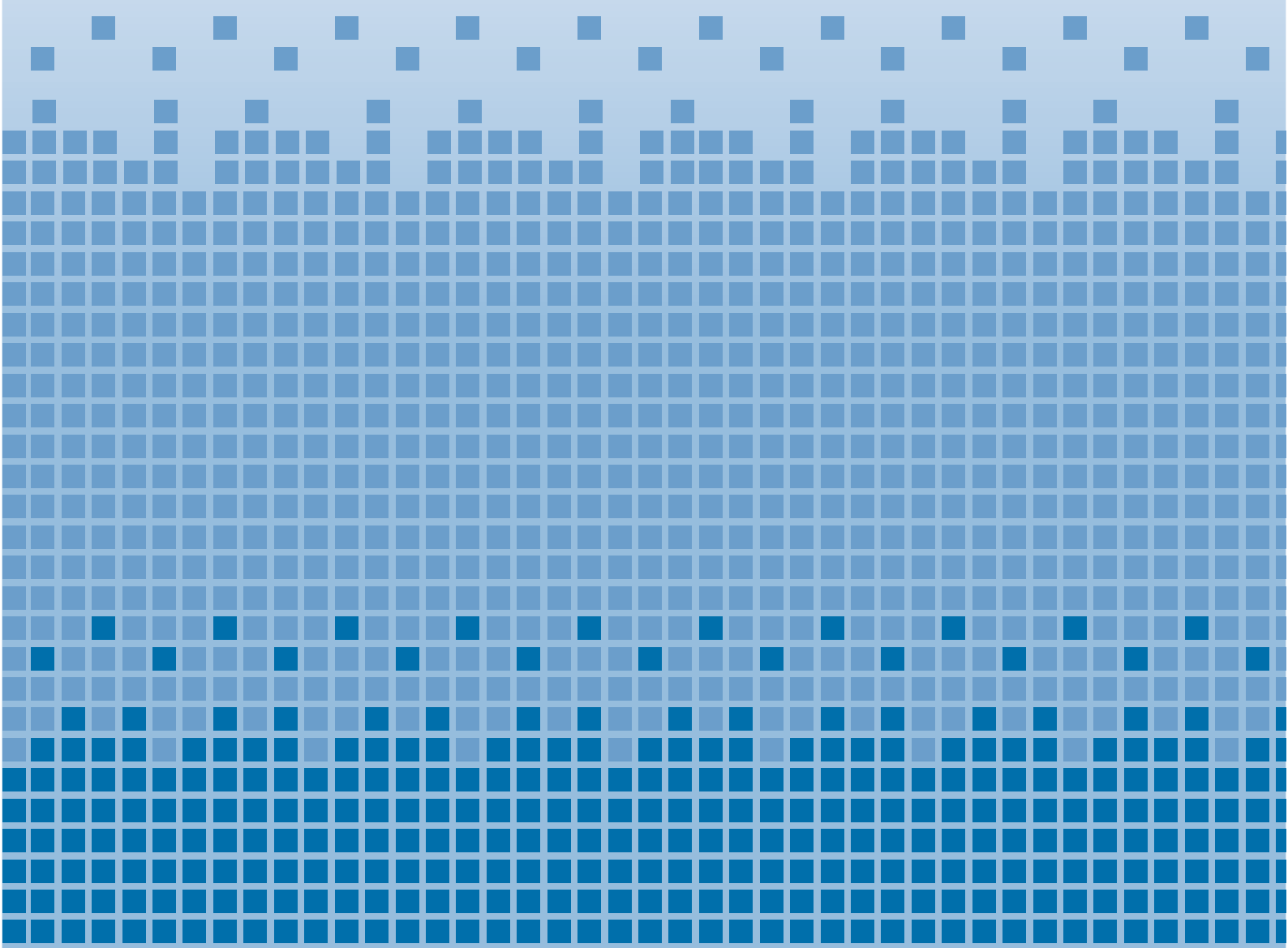

NACHI

Ball & Roller Bearings



Contents

Information	1	
Deep-groove Ball Bearings	139	
Angular Contact Ball Bearings	165	
Self-aligning Ball Bearings	191	
Cylindrical Roller Bearings	201	
Tapered Roller Bearings	229	
Four-row Tapered Roller Bearings	295	
Spherical Roller Bearings	301	
Thrust Ball Bearings	331	
Spherical Roller Thrust Bearings	357	
Precision Machine Tool Bearings	367	
Bearings for Rolling Stock	387	
Sheave Bearings	399	
Ball Bearing Units	407	
Plummer Block Housings	539	
Mounting Accessories	591	
Appendix Table	643	

Information

1. Types and Features of Rolling Contact Bearings	1	6. Internal Clearance of Rolling Contact Bearings	64
1.1 Classification and Types of Rolling Contact Bearings	1	7. Materials for Rolling Contact Bearings	69
1.2 Rolling Contact Bearing Designs and Features	4	7.1 Bearing Ring and Rolling Elements	69
2. Selection of Rolling Contact Bearings	9	7.2 Cage Material	69
2.1 Bearing Type Selection Considerations	10	8. Application of Rolling Contact Bearings	71
3. Load Capacity and Life of Rolling Contact Bearings	15	8.1 Fits and Clearance	71
3.1 Basic Dynamic Load Rating and Rating Life	15	8.2 Preload and Rigidity	95
3.2 Basic Rating Life Calculation Guide	18	8.3 Shaft and Housing Selection	99
3.3 Rating Life and Operating Temperature	22	8.4 Sealing Devices	106
3.4 Calculation of Bearing Load	25	8.5 Lubrication	111
3.5 Dynamic Equivalent Load	29	8.6 Speed Limit	122
3.6 Basic Static Load Rating and Static Equivalent Load	33	8.7 Friction and Temperature Rise	124
3.7 Axial Load Capacity of Cylindrical Roller Bearings	34	8.8 Mounting and Dismounting	125
4. Boundary Dimensions and Bearing Numbers of Rolling Contact Bearings	35	9. Trouble-shooting Bearing Problems	133
4.1 Boundary Dimensions of Rolling Contact Bearings	35		
4.2 Boundary Dimensions of Radial Bearings (Except Tapered Roller Bearings)	37		
4.3 Boundary Dimensions of Tapered Roller Bearings	41		
4.4 Boundary Dimensions of Thrust Bearings with Flat Back Face	43		
4.5 Dimensions of Snap Ring Grooves and Snap Rings	45		
4.6 Rolling Contact Bearing Numbers	49		
5. Accuracy of Rolling Contact Bearings	52		
5.1 Tolerance Values for Radial Bearings (Except Tapered Roller Bearings)	53		
5.2 Tolerance Values for Metric Tapered Roller Bearings	57		
5.3 Tolerance Values for Thrust Ball Bearings	59		
5.4 Tolerance Values of Spherical Roller Thrust Bearings (Class 0)	59		
5.5 Tolerance Values of Tapered Roller Bearings - Inch Series	60		
5.6 Chamfer Dimension Limits	61		
5.7 Tolerances for Tapered Bores	63		

Dimensions

Deep-groove Ball Bearings	139	Precision Machine Tool Bearings	367
Deep-groove Ball Bearings	143	High-speed Angular Contact Ball Bearings BNH000 Series	369
Deep-groove Ball Bearings		Double-direction Thrust Angular Contact Ball Bearings TAD20 Series	373
With snap ring groove / With snap ring / Shield type with snap ring	157	Combination Angular Contact Ball Bearings TAH10 Series	375
Angular Contact Ball Bearings	165	Combination Angular Contact Ball Bearings TBH10 Series	376
Angular Contact Ball Bearings Single Mounting / Duplex Mounting	169	Ball Screw Support Bearings TAB Series	381
Double-row Angular Contact Ball Bearings	185	Cross Tapered Roller Bearings	385
Self-aligning Ball Bearings	191	Bearings for Rolling Stock	387
Self-aligning Ball Bearings	195	Journal Bearings for Railway Rolling Stock	389
Cylindrical Roller Bearings	201	Bearings for Pinion	395
Cylindrical Roller Bearings	205	Bearings for Gearwheel	396
Double-row Cylindrical Roller Bearings	225	Ball Bearings for Traction Motor	397
Tapered Roller Bearings	229	Cylindrical Roller Bearings for Traction Motor	398
Tapered Roller Bearings Metric Series	231	Sheave Bearings	399
Tapered Roller Bearings Inch Series	251	Sheave Bearings	401
Double-row Tapered Roller Bearings - Outward	279	Ball Bearing Units	407
Double-row Tapered Roller Bearings - Inward	291	Plummer Block Housings	539
Four-row Tapered Roller Bearings	295	Mounting Accessories	591
Four-row Tapered Roller Bearings Metric Series	297	Appendix Table	643
Four-row Tapered Roller Bearings Inch Series	299	inch – mm Conversion Table	644
Spherical Roller Bearings	301	kgf – N Conversion Table	645
Spherical Roller Bearings	305	kg – lb Conversion Table	646
Thrust Ball Bearings	331	°C – °F Conversion Table	647
Single-direction Thrust Ball Bearings	335	Hardness Conversion Table	648
Single-direction Thrust Ball Bearings Inch Series	347	Tolerance of Shaft	649
Extra Small and Miniature Thrust Ball Bearings TAM Type	349	Tolerance of Housing Bore	651
Extra Small and Miniature Thrust Ball Bearings TG Type (Banded)	350	International Units SI Conversion Table	653
Double-direction Thrust Ball Bearings	351	SI Prefixes	654
Spherical Roller Thrust Bearings	357	Lubricating Greases	655
Spherical Roller Thrust Bearings	359		

1. Types and Features of Rolling Contact Bearings

1.1 Classification and Types of Rolling Contact Bearings

In general, rolling contact bearings may be classified as radial or thrust bearings according to bearing design or they may be classified as ball or roller bearings according to the type of rolling element. Radial bearings are mainly designed for supporting a load perpendicular to a shaft axis,

whereas thrust bearings accept loads parallel to the shaft axis. Using the BALL and ROLLER classification ROLLER bearings may be further divided according to the shape of the roller into the sub-classes; Cylindrical roller, Tapered roller, Spherical roller, or Needle roller bearings. BALL

bearings can be further divided according to the number of rows into either single-row or double-row (for Thrust Ball bearings, single-direction and double-direction.) BALL Bearing may be still further sub-divided into smaller segments according to the relationship between the

bearing rings and rolling elements; the shape of bearing rings; and use of accessories. Bearings are also classified by specific application, such as wheel bearings for automotive applications.

Table 1.1 Classification and Types of Rolling Contact Bearings

Radial Bearings

Ball Bearings					
Bearing Types		Cross Sections	Bearing Series Symbols		
			JIS	Others	
Deep Groove Ball Bearings	Single row	Without filling slot (JIS B 1521)	00860 RLS RMS 16000		
	Double row	Without filling slot (for units; JIS B 1558)	UC LWE LW UK	U B KH	
		With filling slot			
		Without filling slot			
Counter-Bore Bearings	Single row	Non-Separable			
	Double row	Separable (JIS B 1538)	F EN	BM	
Angular Contact Ball Bearings	Single row	Non-Separable (JIS B 1522)	79 73 72 71 70		
	Double row	Separable			
		Without filling slot		52 53	
		With filling slot		32 33	
DB mounting	DF mounting	DT mounting			
	Double row	Outer ring raceway: spherical (JIS B 1523)	12 13 22 23		

Roller Bearings					
Bearing Types		Cross Sections	Bearing Series Symbols		
			JIS	Others	
Cylindrical Roller Bearings	Single row	Without loose rib		N2 N22 N23 N24	
		With loose rib		NH2 NH22 NH3 NH4	
		Inner ring with a rib	Outer ring with ribs on both sides (JIS B1533)		N10 N12 N13 N14
		Inner ring without rib		NF2 NF3 NF4	
	Double row	Inner ring with ribs on both sides	Outer ring with a rib (JIS B1533)		N2 N3 N4
		Inner ring with ribs on both sides	Outer ring without rib (JIS B1533)		NN30
		Inner ring without ribs on both sides	Outer ring with ribs on both sides (JIS B1533)		NN49
	Needle Roller Bearings	Single row	Inner ring without rib		NA48 NA49
		Double row	Without inner ring		RNA48 RNA49
	Tapered Roller Bearings	Single row	Separable (JIS B1534)		329 322 323 324 325
Double row		Separable (Inward)		KBD	
		Separable (Outward)		KBE KDE	
		Separable			
Spherical Roller Bearings	Single row	Outer ring raceway: spherical			
	Double row	Outer ring raceway: spherical (JIS B1535)		229 228 230 240 231 241	

Thrust Bearings

Ball Bearings				
Bearing Types		Cross Sections	Bearing Series Symbols	
			JIS	Others
Thrust Ball Bearings	Single direction	Flat back face (JIS B 1532)		511 512 513 514
		Flat back face		TMM
		Flat back face		TG
	Double direction	Spherical back face		532(U) 533(U) 534(U) 537(U) 5076(U)
		Flat back face (JIS B 1532)		522 523 524
		Spherical back face		542(U) 543(U) 544(U)
Thrust Angular Contact Ball Bearings	Single direction	Non-Separable (DB, DF, Others)		TAB
	Double direction	Separable		TAD

Roller Bearings				
Bearing Types		Cross Sections	Bearing Series Symbols	
			JIS	Others
Thrust Cylindrical Roller Bearings	Single direction	Flat back face		TMP
		Flat back face		
Thrust Tapered Roller Bearings	Single direction	Outer ring raceway: spherical (JIS B 1539)		292 293 294

Bearings for Specific Application

Bearing Types		Cross Sections	Bearing Series Symbols	
			JIS	Others
Journal Bearings for Rolling Stocks				FCD JC AP
				JT
Sheave Bearings				E50 RB48 RC48

Table 1.2 Type and Features of Rolling Contact Bearings

Bearing Type	Features	Load carrying capacity	High speed rotation	Accuracy	Low noise-Low torque	Permissible aligning of inner ring-outer ring	Rigidity	Aligning action	Separable inner ring-outer ring	Applicable to "fix side"	Applicable to "free side"	Inner ring with tapered bore	Reference pages
Deep Groove Ball Bearings		↑	●●●●	●●●	●●●	●●	●			○	□	○	139
Angular Contact Ball Bearings		↑	●●●●	●●●	●●●	●	●						165
Double row Angular Contact Ball Bearings		↑	●●●	●	●	●	●			○	□		185
Duplex Mounting Angular Contact Ball Bearings		↑	●●●	●●●	●●	●	●●			○	□		169
Self-Aligning Ball Bearings		↑	●●	●	●	●●●	●	○			□	○	191
Cylindrical Roller Bearings		↑	●●●	●●●	●●	●	●		○		○	○	201
Double row Cylindrical Roller Bearings		↑	●●●	●●●	●●	●	●●●		○		○	○	225
Cylindrical Roller Bearings With One Rib Inner Ring		↑	●●●	●●	●●	●	●●		○				201
Cylindrical Roller Bearings With L-shaped Thread Collar		↑	●●●	●●	●●	●	●●		○	○			201
Needle Roller Bearings		↑	●●●	●	●	●	●●		○		○		—
Tapered Roller Bearings		↑	●●	●●●	●	●	●●		○				229
Double-row Multi-row Tapered Roller Bearings		↑	●●	●	●	●	●●●●		○	○	□		229 295
Spherical Roller Bearings		↑	●●	●	●	●●●	●●●	○		○	□	○	357
Single Direction Thrust Ball Bearings		↑	●	●●	●●	×	●		○				331
Single Direction Thrust Ball Bearings with Spherical Back face		↑	●	●	●●	●●●	●	○	○				331
Double-direction Thrust Angular Contact Ball Bearings		↑	●●●	●●●	●●	×	●●		○				371
Thrust Cylindrical Roller Bearings		↑	●	●	●	×	●●●		○				—
Thrust Tapered Roller Bearings		↑	●	●	●	×	●●●		○				—
Spherical Roller Thrust Bearings		↑	●	●	●	●●●	●●●	○	○				357
Reference pages		10 15	9 122	52	10 123	10	10 95	10	10	10	10	10 102	—

Remarks: 1. ↑ and → show radial load and axial load respectively ← and ↔ mean single direction and double directions respectively.
 2. Mark "●" shows possibility for getting the characteristics. More number of "●" means much easier than less number. "X" mean "not applicable".
 3. "○" means "applicable"; "□" means "can be applicable", but shaft thermal expansion must be absorbed.
 4. Thrust Ball/Roller Bearings can sustain axial loads ONLY.
 5. This table is for reference only. Bearings should be selected for specific applications.

1.2 Rolling Contact Bearing Designs and Features

Rolling Contact Bearings usually consist of an inner ring, outer ring, and rolling elements (balls or rollers), and a cage which positions the rolling elements at fixed intervals between the ring raceways. (See Figure 1).

Standard materials for inner and outer rings, and for the rolling elements, are high carbon chromium bearing steel or case hardening steel. The steel is heat-treated to an appropriate hardness to attain optimum resistance to rolling fatigue. Bearing surfaces are ground to a very high accuracy using special machine tools.

While each of the various types of rolling contact bearings has special features, the following features are common to most rolling contact bearing types:

- Rolling contact bearings have relatively low starting resistance. There is little difference between the starting and running resistance of rolling contact bearings.
- Dimensions and accuracy are standardized. Ready-made products of high quality are easy to obtain.
- Compared to "sliding" bearings, rolling contact bearings are less prone to wear and help to maintain the accuracy of the machine in which they are used.
- Rolling contact bearings consume small amounts of lubricant and are far less costly to maintain than sliding-type bearings.

To get optimum performance from a selected bearing, it is necessary to understand the design and features of the various bearing types and to then select bearings optimal to individual machine performance.

1.2.1 Deep Groove Ball Bearings

Deep Groove ball bearings are the most popular of all the ball bearing types because they are available in a wide variety of seal, shield and snap-ring arrangements.

The bearing ring grooves are circular arcs made slightly larger than the radius of the ball. The balls make point contact with the raceways (elliptical contact when loaded). The inner ring shoulders are of equal height (as the outer ring shoulders).

Deep Groove ball bearings can sustain radial, axial, or composite loads and because of simple design, this bearing type can be produced to provide both high-running accuracy and high-speed operation.

Deep Groove ball bearings having an outside diameter less than 9 mm are known as Miniature ball bearings. Deep Groove ball bearings having an outside diameter ≥ 9 mm and a bore diameter < 10 mm are known as Extra-small ball bearings.

Standard ball retainers (cages) are made from pressed steel. Machined cages are used in bearings operating at very high speeds or for large diameter bearings.

Deep groove ball bearings with seals or shields

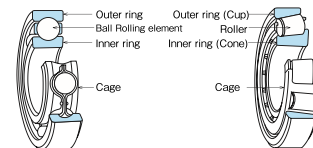

Fig 1. Rolling Contact Bearing Designs



are standardized. They contain proper amount of grease in advance.

1.2.2 Single-row Angular Contact Ball Bearings

The raceways of both the inner and outer rings of this bearing type are made with a set contact angle. These bearings are non-separable. Since the balls are inserted utilizing counter-bore construction, a larger number of balls can be installed than in the case of Deep-groove ball bearings.

Standard cage materials may be pressed steel, high-strength brass, or synthetic resin. Cage material is dependent on the bearing series and or service condition.

Single-row Angular Contact ball bearings can sustain radial, axial or composite loads, however, any axial load must be in one direction.

This bearing type is generally used in pairs to handle the induced load resulting from the internal axial force generated by the applied radial load. When mounting two single bearings in adjacent positions, NACHI provides these combination parts (pairs) with preadjusted clearance. Paired combination bearings are matched sets. Combination or paired bearings can be arranged BACK-TO-BACK (DB), FACE-TO-FACE (DF), or in TANDEM (DT). DB or DF sets can sustain bidirectional axial loads.

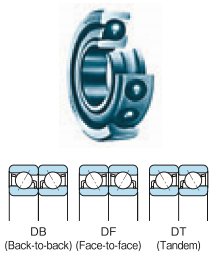

1.2.3 Double-row Angular Contact Ball Bearings

The construction of this ball bearing type is similar to the adjacent, BACK-TO-BACK mounting of two Single-row Angular Contact ball bearings. Because fewer balls can be inserted per row compared to Single-row Angular Contact ball bearings, a Double-row Angular Contact ball bearing will have less load capacity than an equivalent size/series BACK-TO-BACK set of two Single-row Angular Contact ball bearings.

This type bearing can sustain radial, moment and bi-directional axial loads.



1.2.4 Self-aligning Ball Bearings

This type is constructed with the inner ring and ball assembly contained within an outer ring which has a spherical raceway. Due to the construction, this bearing type will tolerate a small angular misalignment from deflection or mounting error.

Self-aligning Ball bearings are suitable for long

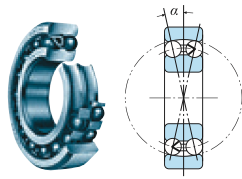

shafts where accurate positioning of housing bores is difficult. This type is often used in conjunction with pillow blocks. Cages are made from pressed steel or polyamide resin.

This bearing should only be used in light axial load applications due to the small axial support of the rolling elements by the outer ring raceway.

1.2.5 Cylindrical Roller Bearings

Construction of this roller bearing type is the simplest of all radial roller bearings. This bearing type is often used in high-speed applications. Because the inner ring, outer ring, and rollers are in line contact, this bearing type has a large radial load capacity. Various Cylindrical roller bearing configurations are:

N,NJ,NF,NU,RNU : integral ribs (flanges)

NH,NP,NUP,NUH : integral and loose ribs

NN,NNU : double-row bearings

(See the Cylindrical roller bearing dimensional data section for description of configuration design).

Configurations having integral flanges or loose ribs on both the inner and outer rings can sustain a small amount of axial load. Since this bearing type supports axial loads as sliding action between the end of the rollers and flange faces, axial loading is limited.

Double-row Cylindrical roller bearings are used for high-speed, high-accuracy applications such as; main spindle support for lathes, milling machines, and machining centers.

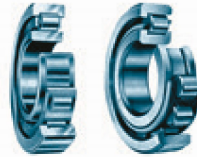

Radial clearance of tapered-bore bearings can be adjusted during mounting of the bearing(s) onto the mating shaft.

Standard cages are pressed steel or polyamide resin. Machined cages of high-strength brass are used for bearings of large dimension or for high-speed applications.

1.2.6 Tapered Roller Bearings

The inner and outer ring raceways and rollers of this type of bearing are made with a taper so that the planes of the surfaces of the raceways and roller axis meet at a point. The rollers are guided by the cone (inner ring) back-face rib.

A single-row Tapered roller bearing can support a combined radial and axial load. If either a radial load or bi-directional axial load is to be carried, a pair of bearings must be used in a "face-to-face" or "back-to-back" position.

Tapered roller bearings are separable into the components: outer ring, inner ring and roller assembly. The non-separable inner ring and roller assembly is called the "cone", and the outer ring is called the "cup". Internal clearance is established during mounting by the axial positioning of the cone relative to the cup.

This bearing type can be used in a preload situation to obtain higher rigidity and better running accuracy of the shaft.

Double-row and four-row Tapered roller bearings are designed to carry radial, and bi-directional axial loads. Four-row Tapered roller bearings are used for the roll necks of rolling

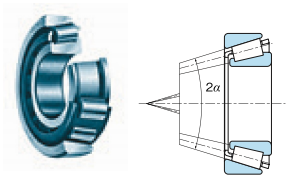

machines and for other applications where heavy or impact loads are present. Multi-row Tapered roller bearings have the serial number and the combination symbol stamped on the faces of the rings for clearance adjustment and must be assembled according to this number and symbol. Pressed steel cages are used for small bore bearings and machined, high-strength brass or mild-steel cages are used for bearings with larger bores. Heavy-duty pin-type cages are used for some large-bore bearings.

1.2.7 Spherical Roller Bearings

NACHI double-row Spherical roller bearings are available in bore sizes from 25 mm to over 1000 mm. The raceways in the outer ring of this type bearing are designed with a spherical surface whose center coincides with the bearing center. NACHI Spherical roller bearings are of an improved design having a modified line contact between the raceways and rollers. This construction enables very high radial and impact-load capacity. This bearing type can carry a moderately-high level of bi-directional axial load and is self-aligning. This type is used extensively for large machines where shaft deflection or mounting error may occur. Spherical roller bearings are used for paper mill equipment, rolling machines, rolling stock, shaker screens and general industrial

machinery. The mounting and dismounting of Spherical roller bearings is facilitated through the use of tapered-bore bearings in conjunction with tapered shaft, or adapters or withdrawal sleeves. Internal clearance can also be precisely set using a tapered-bore bearing. Pressed steel cages are used for small-bore bearings and machined, high-strength brass cages are used for bearings with larger bores.

1.2.8 Thrust Ball Bearings

Thrust ball bearings can handle axial loads only. Bearing rings mounted on the shaft are called shaft washers, and those mounted in the bearing housing are called housing washers. Both washers contain grooves for the balls. Thrust Ball bearings are of two types: single type which can support axial loads in only one direction and double type that can support bi-directional loads. The central washer of double type thrust ball bearing is located in an axial direction by a shaft shoulder and sleeve. Thrust Ball bearings are not suitable for high-speed rotation since lubricant is expelled by centrifugal force. When used on a horizontal shaft, a minimum axial load must be applied. Pressed steel plate, polyamide resin, machined high-strength brass or mild steel are used for cages. Care must be taken in handling to prevent damage to the separable rings and ball assembly.

1.2.9 Spherical Roller Thrust Bearings

The raceway of housing washer of this bearing type is spherical with the center of the radius located on the bearing axis. The design provides self-alignment capability to the bearing. The contact angle (see sketch below) is approximately 45° enabling the bearing to support axial load and a small to moderate amount of radial load.

NACHI Spherical Roller Thrust bearings can sustain high loads at low-to-moderate speeds. Because of the large load capacity and self-aligning characteristics, this bearing type is often used for injection molding machines, crane hooks and other large machines. Cages are made from machined, high-strength brass or pressed steel.

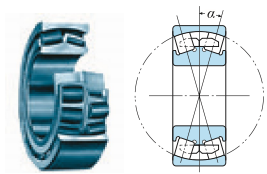
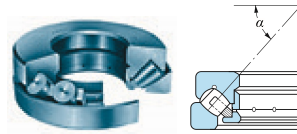

2. Selection of Rolling Contact Bearings

Rolling contact bearings are important, often critical, components of machinery. To meet the demands of a large variety of applications, rolling contact bearings are manufactured in a wide variety of types, sizes, and configurations. While machine performance and service life depend on which bearings are selected, it is

often difficult to select the optimal bearing from among the many available variations. While there is no "best" procedure for selecting the optimal bearing, Figure 2.1 provides an example of a procedure based on the establishment of priorities for the required bearing characteristics.

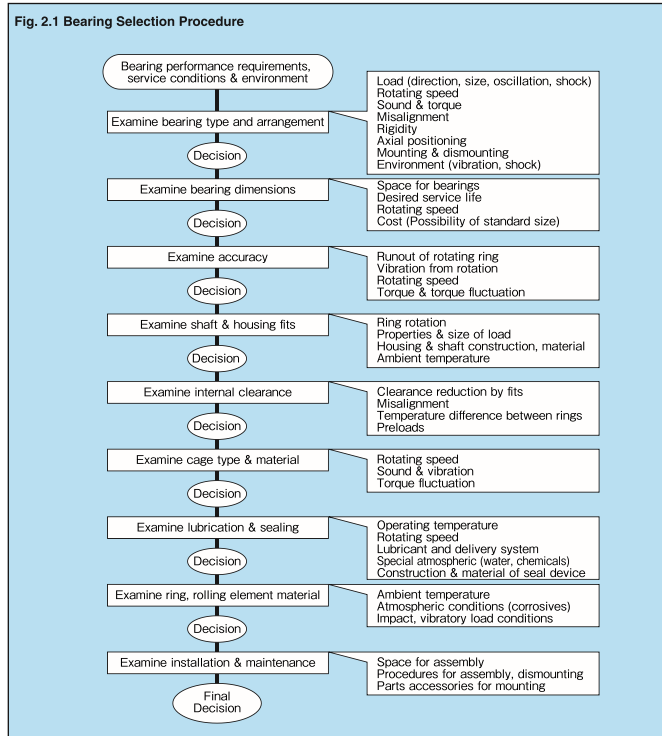

2.1 Bearing Type Selection Considerations

2.1.1 Load

Bearing types are selected according to the types of load (radial, axial, moment) and the magnitude of these loads on the bearing. Table 2.1 outlines the types of load and applicable bearing types. In bearings of identical dimensional series, a roller bearing will have a greater load rating capacity than a ball bearing.

2.1.2 Rotating Speed

Limiting speed of bearings is determined by bearing type, bearing dimensions, accuracy of work, construction of cages, load, lubricating system, and seal type and design. The bearing dimension tables show the rotating speed limits of standard rolling contact bearings as a guide of bearing type selection. Bearings used at high rotating speeds should generally have high accuracy. In applications over the limiting speed, please consult NACHI for assistance.

2.1.3 Noise and Torque

All NACHI rolling contact bearings are designed and manufactured to operate with low noise and torque levels. Of the many types of ball and roller bearings, single-row deep-groove ball bearings will tend to operate with the lowest noise and torque levels.

2.1.4 Alignment

If the accuracy of alignment of the shaft and bearing housing is poor or the shaft is deflected due to load, the inner and outer rings of the bearings will be misaligned. Non-self-aligning rolling contact bearings are capable of tolerating only that amount of misalignment which can be handled by the assembled internal clearance. If large inclination is expected to occur between the inner and outer rings, the choice of bearings should be

from types such as thrust ball bearings with self-aligning washer, Self-aligning ball bearings, or Spherical roller bearings.

The permissible angle of inclination of bearings differs by bearing type, internal clearance, and load conditions. Table 2.2 outlines the permissible angles of misalignment by bearing type.

Internal bearing damage can occur if misalignment in the bearing is greater than the permissible angle. Please contact NACHI for assistance.

2.1.5 Rigidity

When rolling contact bearings are loaded, the contact section between the bearing rings and rolling elements will elastically deform. The magnitude of this elastic deformation will differ depending on load, bearing type, and bearing dimensions.

If bearings of identical dimension series are compared, roller bearings will have a much higher level of rigidity than ball bearings, and if bearings of identical type are compared, bearings of larger dimensions will have higher rigidity than those of smaller dimensions. (Preloading combinations of units of two or more bearings will increase rigidity.)

2.1.6 Mounting, Dismounting

Rolling contact bearings can be divided into bearing types classed as separable or non-separable. Mounting and dismounting is facilitated if a separable bearing type is used. Use of tapered-bore bearings and sleeves or hydraulic assist also makes bearing mounting and dismounting easier.

There is a possibility that noise and shortening of life occur due to poor mounting of bearings. When bearings are mounted, the following items should be noticed.

- Keep the bearings clean

- Prevent from Rusting
- Protect bearings from damage

2.1.7 Axial Location; Bearing Arrangement

Generally the shaft is supported by two units (or the equivalent to two units) of bearings. Generally, one of the bearings acts to hold (or fix) the axial position of the assembly and the other bearing acts to allow linear expansion. The fixed side bearing must be firmly seated against both housing and shaft. Table 2.3 shows representative examples of actual bearing arrangements according to service conditions.

2.1.8 Bearing Environment

If there is a comparatively large source of vibration near the bearing mount, or if the bearing is to handle impact loading, the use of Spherical roller bearings or Spherical roller thrust bearings is recommended. Standard bearings will not be suitable to operate under severe condition (load, rotating speed, operating temperature, lubrication amount, vibrating environment).

Table 2.1 Applicable Bearings vs Load Type

Bearing type	Load type		●		●		●	
	Radial	Axial	●	●	●	●	●	●
Single row Deep-groove Ball Bearings	○	△	○	○	○	○	△	○
Single row Angular Contact Ball Bearings		○	○					
Duplex Angular Contact Ball Bearings	○	○	○	○	○	○	○	○
Double row Angular Contact Ball Bearings	○	△	○	○	○	△	○	
Cylindrical Roller Bearings	○		△					
Single row Tapered Roller Bearings		○	○	○	○	○	○	○
Double row Tapered Roller Bearings	○	○	○	○	○	○	○	○
Four-row Tapered Roller Bearings	○	○	○					
Spherical Roller Bearings	○		△					
Thrust Ball Bearings-Thrust Roller Bearings		○					△	

Remarks: ○ Bearing type can meet the load type.
 △ Bearing can meet the load type conditionally. (Contact NACHI for more information.)

Table 2.2 Permissible Misalignment of Bearing Types

Bearing Type	Permissible angle of misalignment
Single row Deep-groove Ball Bearings	1/300
Single row Angular Contact Ball Bearings	1/1000
Cylindrical Roller Bearings	1/1000
Tapered Roller Bearings	1/800
Thrust Ball Bearings	1/2000

Table 2.3 Example of Bearing Arrangements

No.	Mounting examples	Applicable bearings		Application & design considerations
		A	B	
①		Deep Groove Ball Bearing	Deep Groove Ball Bearing	<ol style="list-style-type: none"> Popular mounting. Ball bearings can support light-to-moderate axial loads. One of the bearing outer ring must be free to move axially to handle thermal expansion. Spherical roller bearings are good for heavy radial loads and light axial loads.
		Spherical Roller Bearing	Spherical Roller Bearing	
②		Cylindrical Roller Bearing; N, NU configuration	Deep Groove Ball Bearing	<ol style="list-style-type: none"> Popular mounting. Not recommended to be used to handle angular misalignment and shaft deflection. One of the bearings outer rings does not need to be configured to move. Cylindrical roller bearing used on side that supports heavy load.
③		Cylindrical Roller Bearing; NH configuration	Cylindrical Roller Bearing; N, NU configuration	<ol style="list-style-type: none"> Easy mounting arrangement where interference fit is required for both inner and outer rings. Not recommended for handling angular misalignment. Thermal expansion taken internally. Suitable for light axial load applications.
④		Deep Groove Ball Bearing	Deep Groove Ball Bearing	<ol style="list-style-type: none"> Preloading allows good rigidity. Care must be taken in design of preload amount. Angular contact ball bearings are better than Deep groove ball bearings for moderate axial loads and preload.
		Angular Contact Ball Bearing	Angular Contact Ball Bearing	
⑤		Deep Groove Ball Bearing	Double row Angular Contact Ball Bearing	<ol style="list-style-type: none"> Good for comparatively heavy axial loads that bear on either the left or right side. Outer ring needs to be allowed to move right and left when deep groove ball bearing is used for side <A>. This is not needed if a cylindrical roller bearing is used and it is good for supporting larger radial loads.
		Cylindrical Roller Bearing; N, NU configuration	Double row Angular Contact Ball Bearing	
⑥		Self-Aligning Ball Bearing	Self-Aligning Ball Bearing	<ol style="list-style-type: none"> Good for angular misalignment and shaft deflection. Use with adapter for long shafts which eliminates shaft shoulders and threading. Outer ring of one bearing must be free to move in order to compensate automatically for thermal expansion or mounting errors. Not recommended for large axial loads.
		Spherical Roller Bearing	Spherical Roller Bearing	

No.	Mounting examples	Applicable bearings		Application & design considerations
		A	B	
⑦		Tapered Roller Bearing	Tapered Roller Bearing	<ol style="list-style-type: none"> General application, direct mounting ("face-to-face"). Good for heavy axial loads and preloading. Inner ring is attached to the shaft in advance during assembly so inner ring interference is advantageous.
⑧		Tapered Roller Bearing	Tapered Roller Bearing	<ol style="list-style-type: none"> Indirect mounting ("back-to-back"). Good for providing rigidity to shaft, especially when using short moment for bearing spacing. Good for large axial loads. Often assembled with preloading, but need to be cautious of preloading amount. Also, inner clearance must be adjusted carefully when inner clearance is not provided.
		Angular Contact Ball Bearing	Angular Contact Ball Bearing	
⑨		Tapered Roller Bearing	Cylindrical Roller Bearing; N, NU configuration	<ol style="list-style-type: none"> Used when accurate rotation is needed with comparatively heavy loads. Preload to provide rigidity on side <A>. Allows prevention of assembly error and thermal expansion in axial direction for cylindrical roller bearings. Shaft and housing precision is good, assembly error must be reduced.
⑩		Combination Angular Contact Ball Bearing	Combination Angular Contact Ball Bearing	<ol style="list-style-type: none"> Used when accurate rotation is needed with light loads. Provides shaft rigidity through preload configuration for each bearing. Inner clearance not normally provided. Two bearings are set as a paired assembly, bearings must be examined for precision. Mounting example above the shaft center line is DB assembly (called DF type when reversed), the lower part is called DT assembly.
⑪		Deep Groove Ball Bearing & Thrust Ball Bearing	Cylindrical Roller Bearing	<ol style="list-style-type: none"> Thrust ball bearing should be close to radial bearing to reduce shaft deflection. When using a thrust ball bearing on a horizontal shaft, preloading must be done so that clearance does not occur between washer and rolling elements. If shaft deflection or assembly error cannot be avoided, use thrust ball bearing with aligning seat or spherical back-face type.
		Cylindrical Roller Bearing & Thrust Ball Bearing	Cylindrical Roller Bearing	
⑫		Spherical Roller Thrust Bearing	(Radial Bearing)	<ol style="list-style-type: none"> Can be used when radial load is 55% or lower than the axial load. Has self-aligning capability which can absorb housing error. Good for heavy axial load. Not normally used for high-speed rotation components. Normally used in conjunction with radial bearings. Use with preload.

3. Load Capacity and Life of Rolling Contact Bearings

3.1 Basic Dynamic Load Rating and Rating Life

Although requirements of rolling contact bearings vary somewhat with the individual application the principal requirements are:

- High load capabilities
- Smooth and quiet rotation
- High rigidity
- Low friction
- High accuracy
- Reliability

The reliability or durability requirement sets the time frame over which all other requirements are to be maintained. The reliability requirement (life in the broad sense) includes grease and acoustic life, as well as fatigue life. Reliability is reduced by various types of damage and degradation.

Improper handling, mounting, lubrication, and fits are the major causes of problems leading to lower-than-calculated bearing life. Regardless of how well they are maintained or mounted or handled, dynamic bearings will eventually fail from rolling fatigue generated by the repetitive stress of bearing load.

The service life of a bearing can be examined from two perspectives: 1) If, from inspection, a trace of fatigue becomes noticeable, the bearing should be deemed not suitable for further use; or 2) length of bearing life in hours or revolutions can be predefined as a limit beyond which the bearing is automatically replaced.

Since calculated fatigue life will vary with the size and type of bearings used under identical load conditions, great care must be taken in the analysis of the load conditions and the final choice of bearings to satisfy the application requirements.

Fatigue lives of individual bearing are dispersed. When a group of identical bearings operate under the same conditions, the statistical phenomenon of dispersion will appear. Use of average life is not an adequate

criterion for selecting rolling contact bearings. Instead, it is more appropriate to consider a limit (hours or numbers of revolutions) which a large percentage of the operating bearings can attain.

Accordingly, the rating life and basic dynamic load rating Cr or Ca are defined using the following definition:

- Basic rating life is defined as the total number of revolutions (or total operating hours at some given constant speed) that 90% of a group of identical bearings operated individually under equal conditions can complete without suffering material damage from rolling fatigue.
- Basic dynamic load rating (Cr or Ca) is defined as a bearing load of constant direction and size that ends the bearing life after one million revolutions.

Constant-direction radial or thrust loads (for radial and thrust bearings, respectively) are used as the basis of the ratings.

The rating life of bearings is calculated by formulas (3.1) and (3.2):

$$L = \left(\frac{C}{P}\right)^p \dots\dots\dots (3.1)$$

$$L_h = \left(\frac{C}{P}\right)^p \cdot \frac{10^6}{60n} \dots\dots\dots (3.2)$$

Where:

- L : Basic rating life (10⁶ rev.)
- L_h : Basic rating life in hours
- C : Basic dynamic load rating (N).
(Cr for radial bearings and Ca for thrust bearings)
- P : Bearing load
(dynamic equivalent load) (N)
Pr for radial, and, Pa for thrust bearings
- p : 3 for ball, 10/3 for roller bearings
- n : Rotating speed (min⁻¹)

The relationship of f_n, the bearing life factor and f_n, the speed factor, is outlined in Table 3.1.

Formula (3.3) may be used to determine the basic dynamic load rating, C, of bearings given the bearing equivalent load, P, and the operating speed, n, in revolutions-per-minute.

$$C = \frac{P}{f_n} \cdot \left(\frac{L_h}{500}\right)^{1/p} \dots\dots\dots (3.3)$$

The lives of automobile wheel bearings may be defined in kilometers using the formula (3.4).

$$L_s = \frac{\pi \cdot D}{1000} \cdot L \dots\dots\dots (3.4)$$

Where:

- L_s : Kilometer traveled (10³ km)
- D : Outside diameter of wheel (m)
- L : Life in revolutions

Table 3.2 shows values for the life factor, f_n, by application and machine type.

If a bearing is used with vibrating or impact loads or low speed including no rotation, additional study with basic static load rating is required.

Table 3.1 Bearing Basic Rating Life; Life and Speed Factors

	Ball Bearings	Roller Bearings
Basic Rating Life	$L_h = 500 f_n^3$	$L_h = 500 f_n \frac{10}{3}$
Life Factor	$f_n = f_n \frac{C}{P}$	$f_n = f_n \frac{C}{P}$
Speed Factor	$f_n = \left(\frac{10^6}{500 \times 60 n}\right)^{\frac{1}{3}}$	$f_n = \left(\frac{10^6}{500 \times 60 n}\right)^{\frac{3}{10}}$

3.2 Basic Rating Life Calculation Guide

Table 3.2 Guideline for Service Life Factor Required for Various Applications

Application conditions	Application example	Life Factor (f_h)
Infrequent use	Hinges	~1.5
Short period or Intermittent use	Hand tools Agricultural equipment Household apparatus Casting plant cranes	2~3
Intermittent, critical use	Power plant auxiliary machines Assembly line conveyers General crane applications Motors for home air conditioning	3~4
8 hour per day, intermittent	General gearing applications General industrial motors	3~5
8 hour per day, continuous	Cranes in continuous use Air blowers Mechanical power transmission General industrial machinery Industrial wood-working machines	4~5
24 hour per day, continuous	Compressors Mine hoists Marine propeller shafts Rolling machine tables	5~8
24 hours per day, breakdowns not allowed	Paper manufacturing Power plants Water supply equipment Mine water pumps, air blowers	6~

- Determine the bearing life normal to the application by using Table 3.2 to define the life factor, f_h .
- Use rating life charts (nomograms) to calculate life. The nomogram for ball bearings is shown in Fig. 3.4. The nomogram for roller bearings is shown in Fig. 3.5. These nomograms are based on formulas (3.1) and (3.2).
- Where operating temperatures are to be in excess of 150°C, a correction factor must be applied to the bearing basic dynamic load rating. (See Item 3.3.1).
- If the bearings are to operate with vibration or impact loading, or where a bearing mounting or manufacturing error exists, the actual load may be greater than the calculated load. In this case, the calculated load must be multiplied by a safety factor to obtain an approximation of the actual load. For safety factors in actual application, refer to the machine and drive factors. (See Item 3.4.1 and 3.4.2)
- Bearings do not always operate under a constant load. When the bearing operates with a fluctuating load, the load must be converted to a constant size reflecting the effect of the fluctuating load. Conversion may be done using weighted average mean loading (See Item 3.4.4).
- By definition, bearing load P_r (simple radial load) or P_a (simple axial load) is a load with constant direction and size. When a composite load of radial and axial loads occurs on a radial bearing, these loads must be converted to a radial load reflecting the effect of the composite load. This effective load is called the DYNAMIC EQUIVALENT LOAD. (See Item 3.5).
- When calculating bearing load using the loads on a position on the shaft, it is necessary to calculate center distance between the load application point of the bearings. Many bearing types have load center points at the

center line of the width as shown in Fig. 3.1. Single-row Angular Contact ball bearings and single-row Tapered roller bearings, have load center points off-center to the center line of the bearing width (See Fig. 3.2 and 3.3 respectively). Refer to the dimension tables for the value of the off-set.

Fig 3.1

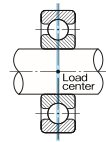

Fig 3.2

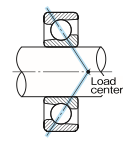
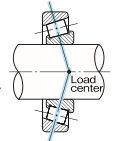

Fig 3.3



- The axial load limit for Cylindrical roller bearings is a function of the lubrication conditions and speed of rotation. This limit differs from a rating load as determined by fatigue life. (See Item 3.7).

Calculation example: 1
Suppose that an application has selection parameters as follows:

- Bore: 50 mm or smaller
- Outside diameter: 100 mm or smaller
- Width: 20 mm or smaller
- Radial load (Fr): 4000 N (Newtons)
- Rotating speed (n): 1800min⁻¹
- Life factor (fn): 2 or greater
- Bearing type: Single-row deep groove ball bearing

From Table 3.1 the speed factor, fn is obtained as follows:

$$f_n = \left(\frac{10^6}{500 \times 60 \times 1800} \right)^{1/3} = 0.265$$

From Table 3.1,

$$C_r = \frac{f_n \cdot P}{f_n} = \frac{2 \times 4000}{0.265} = 30188N$$

Bearings having the required basic dynamic load rating are selected from the bearing dimension table(s). Of the two sizes meeting the load and diameter constraints, only bearing 6209 will satisfy the width constraint. Given the above parameters, bearing part 6209 would be the selection.

Bearing	Bore Dia. (mm)	Outside Dia. (mm)	Width (mm)	Basic Dynamic Load Rating (N)
6209	45	85	19	32500
6307	35	80	21	33500

Fig 3.4

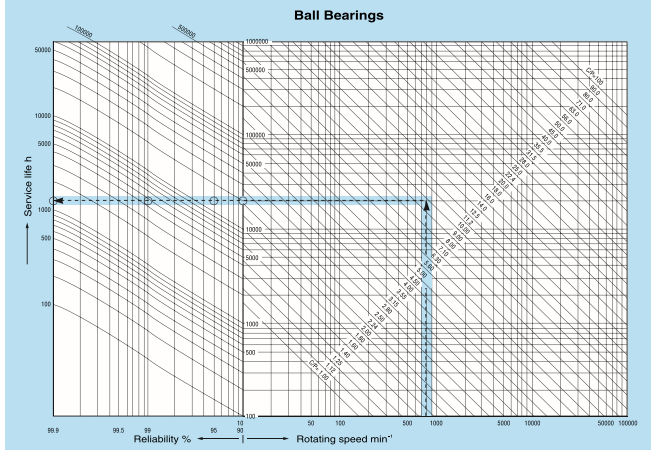

Calculation example: 2

Object is to obtain service live for various levels of reliability for bearing number 6012 loaded with a dynamic equivalent radial load of Pr = 2940N, at rotating speed of n = 800 min⁻¹
Basic dynamic load rating is from dimension table (P147).
Cr=29400N

$$\frac{C_r}{P_r} = 10$$

*See Item 3.3.2 regarding reliability.

According to dotted line in figure;

- *When reliability is 90 % 20000 h
- Reliability is 95 % 15000 h
- Reliability is 99 % 4500 h
- Reliability is 99.9 % 1200 h

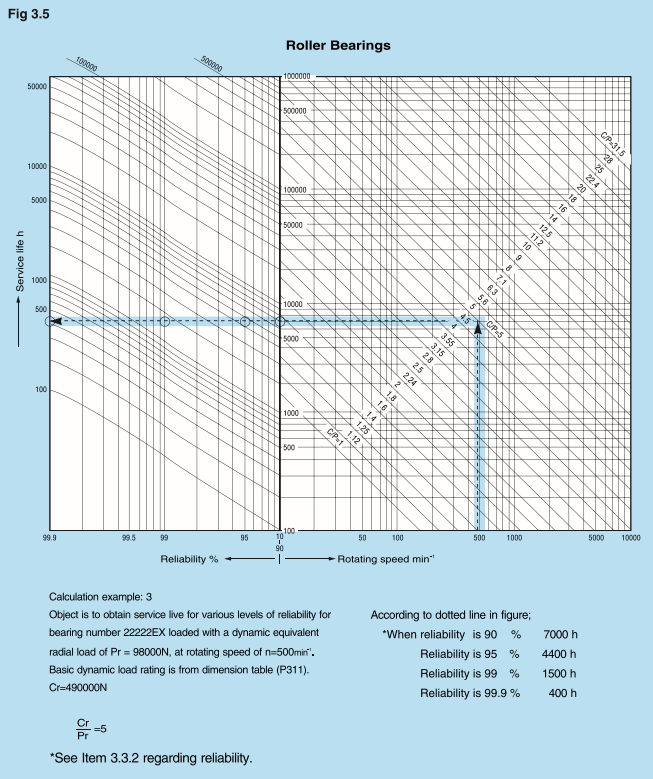

3.3 Rating Life and Operating Temperature

3.3.1 Temperature-Related Decrease in Basic Dynamic Load Rating

Bearing ring diameters grow slightly with an increase in temperature. If the operating temperature does not exceed about 120°C, the bearing rings will return to their original dimensions at normal temperature. If the operating temperature exceeds this level (approximately 120°C), the bearing rings and rolling elements can undergo small, permanent changes in size.

To prevent these permanent changes in size, special heat-stabilization treatment can be used (see Table 3.3).

The S26 heat-treated bearings will resist dimensional change through a maximum temperature of 150°C. Bearings with the S26 heat-treated steel will suffer decreases to their rating life and will have dimensional changes if they are used at temperatures in excess of 150°C.

The S28 heat-treated bearings will resist dimensional change and have a temperature factor of 0.90 through a maximum temperature of 200°C.

If bearings are operated at temperatures exceeding the limit of the heat-stabilization, hardness of the bearing steel will be reduced. In calculating the life of such bearings, the basic dynamic load rating must be multiplied by the temperature factor as shown in Table 3.4.

Standard bearings run at an operating temperature exceeding 150°C, are subject to the basic dynamic load rating decreases as shown in Table 3.4.

Table 3.3 Heat Stabilization Treatment

Operation temperature range	Heat stabilization treatment symbol
~150°C	S26
~200°C	S28

Table 3.4 Temperature Factor

Bearing Temperature	~150°C	175°C	200°C
Temperature Factor	1	0.95	0.90

3.3.2 Life Calculation Factors

Rating Life Formula, $L=(C/P)^p$ (3.1), is used when applying rolling contact bearings for normal use.

To provide for utilization of lubrication theory, and advances in bearing material and bearing manufacturing technology, the ISO and JIS have adopted the following life calculation formula.

Table 3.5 Reliability Factor a_1

Reliability %	99	98	97	96	95	90
a_1	0.21	0.33	0.44	0.53	0.62	1

$$L_{na} = a_1 \cdot a_2 \cdot a_3 \cdot \left(\frac{C}{P}\right)^p \dots\dots\dots (3.5)$$

where:

- L_{na} : Adjusted rating life (10^6 rev.)
- a_1 : Reliability factor
- a_2 : Material factor
- a_3 : Application conditions factor

Formula (3.5) is applicable only when all

bearing loads are considered and operating conditions are clearly defined.

Generally, reliability of 90% is used, and material and operating conditions may be considered as $a_1, a_2, a_3=1$, coinciding with formula (3.1)

1) Reliability Factor, a_1

Reliability Factor, a_1 , becomes 1 if 90% of a group of identical bearings operated individually under the same conditions can complete the calculated life without exhibiting material damage from rolling fatigue. Reliability is then set as 90%, and for reliability over 90%; a_1 takes a value from Table 3.5.

As observed from Table 3.5, the calculated bearing life decreases in proportion to a higher level of bearing reliabilities.

Fig. 3.6 shows the improved reliabilities when bearings having rating lives of 3, 6, 10 and 20 times are used in comparison with the 90% reliability (life-multiplying factor being 1) of a bearing having a given rating life.

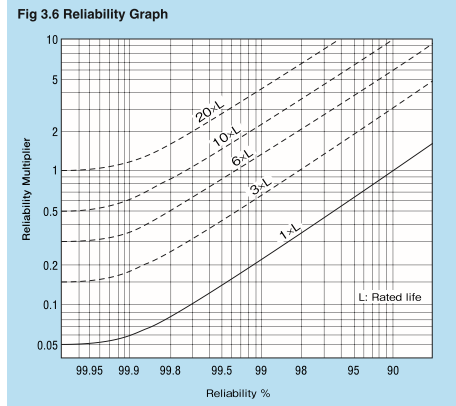

Calculation example: 4

Bearing Number 6209 is used to support a radial load of 3160N. Object is to define the life and select a bearing which will have a reliability of 99.4%.

The life corresponding to the reliability of 90% is obtained as follows by reading the basic dynamic load rating, $Cr=32500N$ from the dimension table and using formula (3.1):

$$\left(\frac{32500}{3160}\right)^3 \times 10^6 = 1088 \times 10^6 \text{ rev.}$$

Reading Fig. 3.6, it can be seen that a bearing having a life -multiplying factor of 6 is required to attain 99.4% reliability. Applying this multiplier to the basic dynamic load rating, Cr as obtained from formula (3.1), will calculate as:

$$\left(\frac{Cr}{3160}\right)^3 \times 10^6 = 6 \times 1088 \times 10^6 \text{ rev.}$$

From the above equation, obtain;

$$Cr = (6)^{1/3} \times 32500 = 1.817 \times 32500 = 59000N$$

The bearing meeting this basic dynamic load rating (in the same diameter series) is bearing number 6214.

2) Material factor, a_2

Material factor, a_2 , is the adjustment factor applied as an increase to rating life for type and quality of material, special manufacturing process and/or special design.

The basic dynamic load rating, Cr (or Ca), listed in the bearing dimension tables reflects both the use of vacuum-degassed, high-carbon chrome bearing steel for all NACHI rolling contact bearings as well as improvements in manufacturing technology. The a_2 -factor has a base value of 1 for NACHI standard parts.

Unless specialty steels are utilized, a_2 is defined as 1 when calculating the life using the formula (3.5).

3) Application condition factor, a_3

The application condition factor, a_3 , is used to consider bearing load conditions, lubricating conditions, and temperature conditions.

Factor a_3 is set as 1 if the rolling elements and raceway surfaces are separated (good lubricating condition). When lubricating conditions are poor (as in the following cases), a_3 is less than 1:

- When the operating speed is slower than $dm \cdot n = 10,000$. (Where $dm \cdot n$ = rolling element pitch diameter in millimeters times the speed in revolutions-per-minute).
- When lubricant has deteriorated.

At present, it is difficult to quantify the application condition factor because of the many variables involved.

Because factors a_2 and a_3 have interactive effects on each other, these two factors are treated as one value (a_2) (a_3). When lubrication and application conditions are good, the value (a_2) (a_3) can be set as equal to 1.

In case of poor lubrication such as when lubricant viscosity is considerably low, please consult NACHI.

3.4 Calculation of Bearing Load

Generally, the load that is applied to bearings is composed of loads generated by machine operation, drive components, and dead weight of the shaft and components mounted to and on the shaft. These loads can be precisely calculated. The above loads are usually accompanied by vibration and impact. With the exception of very special cases, it is impractical to calculate and add the specific effects of vibration and impact loading on each component in a machine. To facilitate the calculation and analysis of loading in a machine system, loading factors (based on empirical experience) have been developed as multipliers to the driving and static loads.

$$F = f_s \cdot F_c \quad (3.6)$$

where:

- F : Bearing load (N)
- f_s : Machine factor (Table 3.6)
- F_c : Calculated load (N)

When a load fluctuates in magnitude, an average load must be calculated which reflects the effects of the fluctuating load.

When a composite load of radial and axial load occurs on a radial bearing, the loads must be converted to an effective radial load by use of the dynamic equivalent load formula for the specific bearing type. This value, P, is used in the basic rating life formula (3.1).

3.4.1 Belt Drives

Transferring power through belt drives requires initial belt tension. Radial load, K, that occurs from this tension can be calculated as follows:

$$M = 955000 \cdot \frac{H}{n} \quad (3.7)$$

$$K_t = \frac{M}{r} \quad (3.8)$$

where:

- M : Rotating moment of pulley (N·cm)

- K_t : Effective transfer power of belt (N) (tension side minus slack side)
- H : Transfer power (kW)
- n : Rotating speed of pulley (min⁻¹)
- r : Radius of pulley (cm)

Load that works on the shaft through the pulley is calculated by multiplying the effective transfer power, K_t, by the belt drive factors, f₁, from Table 3.7.

Generally,

$$K = f_1 \cdot K_t \quad (3.9)$$

where:

- K : Radial load (N) applied to the pulley transferred by the belt
- f₁ : Belt drive factor (Table 3.7)

Table 3.6 Machine Factors (f_s)

Type of Machine	f _s
Rotating machinery with no impact (motors, turbo compressor, conveyors, paper manufacturing machinery)	1~1.2
Machinery with low impact (internal combustion engines, reciprocating pumps, hoists, cranes)	1.2~1.5
Machines with high impact (drop hammers, crushers, rolling mill equipment)	1.5~3.0

Table 3.7 Belt Drive Factors (f₁)

Type of drive	f ₁
Flat leather belt (with tension pulley)	1.75~2.5
Flat leather belt (without tension pulley)	2.25~3.5
Silk belt, rubber belt	2.25~3.5
Balata belt	
V-belt	1.5~2
Steel strip belt	4~6
Cotton belt, hemp belt	2~6

Note: 1. For low speed use top value.

Table 3.8 Gear Factors (f_z)

Type of gear	f _z
Precision gears (Pitch and form errors of less than 0.02 mm)	1~1.1
Normal gears (Pitch and form errors of less than 0.02 to 0.1 mm)	1.1~1.3

3.4.2 Gear Drives

Shaft load from gear drives are calculated using the transfer power and type of gear.

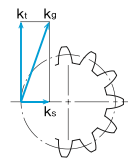

Fig 3.7

Helical, bevel and worm gears transmit radial loads and create an axial load component, while spur gears transmit only radial loads. Gear load formulas described below refer to spur gears.

$$M = 955000 \cdot \frac{H}{n} \quad (3.10)$$

$$K_t = \frac{M}{r} \quad (3.11)$$

$$K_s = K_t \cdot \tan \alpha \quad (3.12)$$

$$K_g = \sqrt{K_t^2 + K_s^2} = K_t \cdot \sec \alpha \quad (3.13)$$

where:

- M : Rotating gear moment (N·cm)
- K_t : Tangential component of force (N)
- K_s : Radial component of force (N)
- K_g : Total gear load (N)
- H : Transfer power (kW)
- n : Rotating speed (min⁻¹)
- r : Drive gear pitch radius (cm)
- α : Pressure angle of gear (°)

K_g, the total theoretical gear load, must be multiplied by both the gear precision factor and the machine factor (the latter of which takes into account impact and other forces dependent on machinery type).

$$K = f_z \cdot f_s \cdot K_g \quad (3.14)$$

where:

- K : Gear load transmitted to shaft (N)
- f_z : Gear precision factor (Table 3.8)
- f_s : Machine factor (Table 3.6)

3.4.3 Load Distribution to Bearings

Load applied to a point on the shaft is distributed to the bearings supporting the shaft. Reference Fig. 3.8,

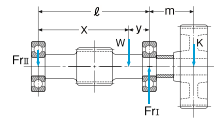

Fig 3.8

$$Fr_I = \frac{l+m}{l} K + \frac{x}{x+y} W \quad (3.15)$$

$$Fr_{II} = \frac{m}{l} K - \frac{y}{x+y} W \quad (3.16)$$

where:

- Fr_I : Load working on bearing I (N)
- Fr_{II} : Load working on bearing II (N)
- K : Gear load transmitted to shaft (N)
- W : Shaft Weight (N)
- l, m, x, y : Relative positions of the points of applied force.

3.4.4 Averaging Fluctuating Loads

A large load will have an emphasized effect on bearing life even if it is applied only for a very short duration of the total life-span of the bearing.

When the size of bearing load fluctuates with a defined cycle, bearing life may be calculated by deriving an average load simulating the affects of the fluctuating load.

(1) Step Type Load Fluctuation

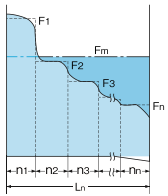

Fig 3.9

$$F_m = \sqrt[3]{\frac{F_1^3 n_1 + F_2^3 n_2 + \dots + F_n^3 n_n}{n_1 + n_2 + \dots + n_n}} \quad (3.17)$$

where:

- F_m : Average of fluctuating load (N)
- n_1 : Total number of revolutions at load F_1 (rev.)
- n_2 : Total number of revolutions at load F_2 (rev.)
- n_n : Total number of revolutions at load F_n (rev.)
- p : 3 for ball; 10/3 for roller bearings

In formula (3.17), if rotating speed is constant, and $(n_1 + n_2 + \dots + n_n)$ is referenced as applied time, then n_1, n_2 and n_n can be replaced by time periods t_1, t_2, \dots, t_n respectively, in the formula.

(2) Linear Load Fluctuation

When the load fluctuates almost linearly (see Fig. 3.10), the following formula is used to obtain the average load.

$$F_m = \frac{1}{3} F_{min} + \frac{2}{3} F_{max} \quad (3.18)$$

where:

- F_m : Average load (N)
- F_{min} : Minimum load (N)
- F_{max} : Maximum load (N)

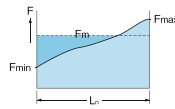

Fig 3.10

(3) Dynamic plus static load fluctuation

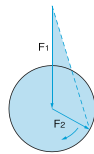

Fig 3.11

Where load F_1 of a constant size and direction, is combined with a constantly revolving load F_2 caused by an unbalanced load on the bearing (see Fig. 3.11), the average load is calculated using formula 3.19.

$$F_m = AF_1 + F_2 \quad (3.19)$$

Value of A is taken from Fig. 3.12.

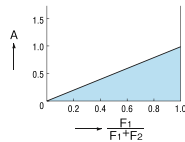

Fig 3.12

Calculation example: 5

A Single-row Deep-groove ball bearing is loaded with the fluctuating radial loads shown below.

Object: to obtain an average radial load on the bearing.

- $F_1=100N$: 800 min^{-1} for 6 sec
- $F_2=50N$: 1800 min^{-1} for 20 sec
- $F_3=200N$: 3600 min^{-1} for 12 sec

Number of revolutions for the individual loads F_1, F_2 and F_3 are derived for the formula as follows.

$$n_1 = \frac{6}{60} \times 800 = 80 \text{ rev.}$$

$$n_2 = \frac{20}{60} \times 1800 = 600 \text{ rev.}$$

$$n_3 = \frac{12}{60} \times 3600 = 720 \text{ rev.}$$

Therefore,

$$n = n_1 + n_2 + n_3 = 1400 \text{ rev.}$$

From formula (3.17),

$$F_m = \sqrt[3]{\frac{100^3 \times 80 + 50^3 \times 600 + 200^3 \times 720}{1400}} = 162 \text{ N}$$

3.5 Dynamic Equivalent Load

Dynamic equivalent load refers to a load having constant direction and magnitude such that theoretical calculations of bearing life using this load will simulate actual bearing life. This load is called dynamic equivalent radial load when calculated for radial bearings and dynamic equivalent axial load when calculated for thrust bearings.

In formula (3.1) expressing the relation between the bearing load and bearing life, bearing load, P_r , is either radial or axial load. Since radial and axial loads often occur simultaneously, the radial and axial loads must be converted to composite load within the dynamic equivalent load formula.

3.5.1 Dynamic Equivalent Radial Load

Dynamic equivalent radial load for radial bearings is calculated using the formula:

$$P_r = X F_r + Y F_a \quad (3.20)$$

where:

- P_r : Dynamic equivalent radial load (N)
- F_r : Radial load (N)
- F_a : Axial load (N)
- X : Radial load factor
(from dimensional tables)
- Y : Axial load factor
(from dimensional tables)

In the above formula, if the axial load to radial load ratio, F_a/F_r , is less than or equal to e (a value determined by the bearing size and load as shown in the dimension tables), X , Y , and P_r will be as follows:

- $X = 1$
- $Y = 0$
- $P_r = F_r$

3.5.2 Dynamic Equivalent Axial Load

While most thrust bearings are incapable of supporting any radial load, Spherical roller thrust bearings will support some radial load. For Spherical roller thrust bearings, the dynamic equivalent axial load is derived using the formula:

$$P_a = F_a + 1.2 F_r \quad (3.21)$$

where:

- P_a : Dynamic equivalent axial load (N)
- F_a : Axial load (N)
- F_r : Radial load (N)
- F_r/F_a must be ≤ 0.55

3.5.3 Dynamic Equivalent Load for Oscillating Loads

The dynamic equivalent load of radial bearings sustaining oscillating movements is derived using the formula:

$$P_r = \left(\frac{\psi}{90^\circ} \right)^{1/p} (X F_r + Y F_a) \quad (3.22)$$

where:

- P_r : Dynamic equivalent load (N)
- ψ : Angle of oscillation (ψ must be $\geq 90^\circ/Z$)
- p : 3 for ball and 10/3 for bearings
- F_r : Radial load (N)
- F_a : Axial load (N)
- X : Radial load factor
(from dimensional tables)
- Y : Axial load factor
(from dimensional tables)
- Z : Number of rolling elements in row

If the value of $\psi < 90^\circ/Z$, the above formula may not accurately predict bearing life since localized wear may be generated in the raceways. (Oil lubrication may be tried to prevent the wear (false brinelling) associated with low-amplitude operation in this type of application).

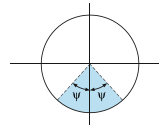

Fig 3.13

3.5.4 Angular Contact Ball; Tapered Roller Bearing Load

For single-row Angular Contact ball and single-row Tapered roller bearings, the load center dimensions from the bearing tables must be used when determining the relative load positions. The load-center positions of these bearings are off-set from the midpoint of the width of these bearings as shown in Fig 3.14 and 3.15.

The off-set dimension for Angular Contact ball and Tapered roller bearings is shown as the value "a" in the dimensional tables to indicate the load-center position. If moment loading is to be considered in a bearing system, location of load-center is of particular importance.

Where l_1 , m_1 , x_1 or l'_1 , m'_1 , x'_1 , and y'_1 are applied to formulas (3.15) and (3.16) as effective intervals instead of l , m , x , and y previously used in formulas (3.15) and (3.16). If a radial load is applied to two units of Tapered roller bearings used in pairs, an induced axial load will be produced. The magnitude of this induced axial force F_a' is calculated using the formula:

$$F_a' = \frac{F_r}{2 Y_1} \quad (3.23)$$

where:

- F_a' : Induced axial load (N)
- F_r : Radial load (N)
- Y_1 : Axial load factor (from dimension tables)

Axial and equivalent radial load on bearing calculated using formulas in Tables 3.9.

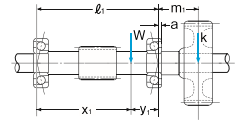

Fig 3.14

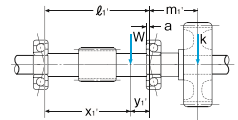

Fig 3.15

F_{rI}, F_{rII} : Radial load applied to bearings I and II (N)
 F_a : External axial load (N) direction shown by Table 3.9
 P_{rI}, P_{rII} : Dynamic equivalent radial load on bearing I and II (N)
 X_I, X_{II} : Radial Load Factor for bearings I and II from dimension tables
 Y_I, Y_{II} : Axial Load Factor for bearings I and II from dimension tables

Table 3.9 Axial and Dynamic Equivalent Load of Angular Contact Ball and Tapered Roller Bearings

Bearing arrangement	Load conditions	Axial load	Dynamic equivalent radial load
	$F_a \geq 0.5 \left(\frac{F_{rI}}{Y_I} - \frac{F_{rII}}{Y_{II}} \right)$	$F_{aI} = F_{aII} + F_a$ $F_{aII} = 0.5 \frac{F_{rII}}{Y_{II}}$	$P_{rI} = X_I F_{rI} + Y_I (F_{aII} + F_a)$ $P_{rII} = F_{rII}$
	$F_a < 0.5 \left(\frac{F_{rI}}{Y_I} - \frac{F_{rII}}{Y_{II}} \right)$	$F_{aI} = 0.5 \frac{F_{rI}}{Y_I}$ $F_{aII} = F_{aI} - F_a$	$P_{rI} = F_{rI}$ $P_{rII} = X_{II} F_{rII} + Y_{II} (F_{aI} - F_a)$
	$F_a \geq 0.5 \left(\frac{F_{rII}}{Y_{II}} - \frac{F_{rI}}{Y_I} \right)$	$F_{aI} = 0.5 \frac{F_{rI}}{Y_I}$ $F_{aII} = F_{aI} + F_a$	$P_{rI} = F_{rI}$ $P_{rII} = X_{II} F_{rII} + Y_{II} (F_{aI} + F_a)$
	$F_a < 0.5 \left(\frac{F_{rII}}{Y_{II}} - \frac{F_{rI}}{Y_I} \right)$	$F_{aI} = F_{aII} - F_a$ $F_{aII} = 0.5 \frac{F_{rII}}{Y_{II}}$	$P_{rI} = X_I F_{rI} + Y_I (F_{aII} - F_a)$ $P_{rII} = F_{rII}$

Notes: 1. Apply when the bearing clearance and preload are 0.
 2. Radial load in the direction opposite to the arrows above is also positive.

3.6 Basic Static Load Rating and Static Equivalent Load

3.6.1 Basic Static Load Rating

Load applied to stationary bearings can create permanent indentations in the load surfaces. While some level of deformation can be tolerated, a level of deformation will be reached where noise and vibration during operation of the bearing, will make the bearing unusable. The term "Basic static load rating" refers to the maximum contact stress value of the static load where the rolling element and raceways contact. The ratings are:

- Self-aligning ball bearing...4600MP_a
- Other ball bearings4200MP_a
- Roller bearings.....4000MP_a

With these contact stresses, the sum of deformations (ball/roller and raceway) is approximately 1/10000 of the diameter of the rolling element.

Basic static load ratings are shown in the dimension tables for each bearing number. The symbol C_{0r} is for radial bearings and the symbol C_{0a} is for thrust bearings.

3.6.2 Static Equivalent Load

Static equivalent load is the static load that reflects the actual load conditions to the contact section of the rolling elements and raceway receiving the maximum stress. For radial bearings, radial load of a constant direction and magnitude is called the static equivalent radial load, and for thrust bearings, axial load of a constant direction and magnitude is called the static equivalent axial load.

1) Static equivalent radial load

To calculate the static equivalent radial load of a radial bearing supporting simultaneous radial and axial loads, the larger of the values obtained from formulas (3.24) and (3.25) are to be used.

$$P_{0r} = X_0 F_r + Y_0 F_a \quad (3.24)$$

$$P_{0r} = F_r \quad (3.25)$$

where:

P_{0r} : Static equivalent radial load (N)

F_r : Radial load (N)
 F_a : Axial load (N)
 X₀ & Y₀ : Static radial and axial load factors from dimension tables

2) Static equivalent axial load
 Static equivalent axial load for Spherical Thrust bearings is calculated using formula (3.26)

$$P_{0a} = F_a + 2.7 F_r \quad (3.26)$$

where:

P_{0a} : Static equivalent axial load (N)
 F_a : Axial load (N)
 F_r : Radial load (N)
 F_r/F_a must be ≤ 0.55

3.6.3 Safety Factor

The basic static load rating is considered as the limiting load for general applications. An application may require a safety factor larger than 1 or allow a safety factor smaller than 1. Table 3.10 provides a guide for selection of the safety factor, S₀, to be used with formula (3.27) for calculation of the maximum (weighted) static equivalent load.

$$C_0 = S_0 \cdot P_{0max} \quad (3.27)$$

where:

C₀ : Basic static load rating (N)
 (C_{0r} for radial; C_{0a} for thrust bearings)
 S₀ : Safety factor (select from Table 3.10)
 P_{0max} : Static equivalent load (N)

Table 3.10 Static Safety Factor S₀

Application conditions	S ₀	
	Ball Bearings	Roller Bearings
High rotating accuracy is needed	2	3
Vibration and / or impact present	1.5	2
Normal operating conditions	1	1.5
Small amount of permanent deformation is tolerable	0.7	1

Note: Use value over 4 for Spherical Roller Thrust Bearings

3.7 Axial Load Capacity of Cylindrical Roller Bearings

Cylindrical roller bearings are generally used for supporting radial loads only. Bearings having flanges or loose ribs on both the inner and outer rings (such as on configurations NJ, NF, and NUP), are capable of supporting some amount of axial load. Since any axial loading on a cylindrical roller bearing is supported by a "sliding" action between the roller ends and flanges, allowable axial load is based on the limiting values of heat, seizure, and wear caused by this "sliding" contact.

Permissible axial loading (no consideration of bearing life as a radial bearing) on Cylindrical roller bearings is calculated using the following formula.

$$F_a = (p_v) \frac{\lambda}{n} \quad \text{Allowable axial load (N)}$$

p_v : Application factor from Table 3.11.1

λ : Bearing type factor from Table 3.11.2

n : Rotating speed (min⁻¹)

However, there is another limit shown by the following formula because Fa exceeding the limit causes abnormal roller movement

$$\text{Allowable axial load} \leq k_1 \cdot Fr$$

Bearing series	k ₁
1000, 200, 200E 300, 300E, 400	0.2
2200, 2200E, 2300, 2300E	0.4

Table 3.11.1 Application Factor (p_v)

Operating conditions (Load and lubrication)	(p _v)
Intermittent axial load, good heat conduction and good cooling or very large amount of lubricant	5400~ 6900
Intermittent axial load, good heat conduction and large amount of lubricant	2600~ 3200
Oil lubrication, good heat conduction or good cooling	1900~ 2200
Continuous axial load and oil lubrication or intermittent axial load and grease lubrication	1300~ 1600
Continuous axial load and grease lubrication	690~ 780

Table 3.11.2 Bearing Type Factor λ

Diameter Series	λ
0	19d
2	32d
3	45d
4	60d

d = bearing bore (mm)

When cylindrical roller bearings have an applied axial load, additional considerations are required as follows;

- Apply sufficient radial load to overcome axial load
- Supply sufficient lubricant between roller ends and flanges
- Use lubricant which has good film strength (pressure resistant) properties
- Practice good bearing mounting accuracy (see section 8.3)
- Allow sufficient running-in
- Minimize radial bearing clearance

4. Boundary Dimensions and Bearing Numbers of Rolling Contact Bearings

4.1 Boundary Dimensions of Rolling Contact Bearings

Boundary dimensions have been established in a standard plan for metric rolling contact bearings to facilitate the selection process, improve availability, and to limit the necessity for use of high cost, non-standard parts. Boundary dimensions standards include the bore diameter (d), outside diameter (D), width (B), assembly width (T) or height (H), and the chamfer dimension (r) of bearings.

Boundary dimensions are standardized by the International Organization for Standardization (ISO 15) and also Japanese Industrial Standard (JIS B 1512). NACHI has adopted the ISO boundary dimension standards. Figures 4.6 and 4.7 show the relationship of the dimensions for radial and thrust rolling contact bearings (except for Tapered roller bearings).

Table 4.1 Boundary Dimensions Terminology

Series	Definition	Remarks
Diameter series	The diameter series is a series of standard outside diameters with standard bore diameters. Several series of outside diameters are set in stages to the same bearing bore diameter. Diameter series are labeled by single digit numbers 7, 8, 9, 0, 1, 2, 3, and 4.	(1) Diameter series is in ascending order by diameter size with number 7 the smallest and 4 the largest. (2) Each radial bearing diameter series has width series with numbers 8, 0, 1, 2, 3, 4, 5, 6. Number 8 is the minimum width to the same bore and outside diameter. Number 6 is the maximum width.
Width or Height series	Width or height series is a series of standard widths or heights with the same bore diameter within the same diameter series of bearings. These width or height series are labeled with single digit numbers. Width series 8, 0, 1, 2, 3, 4, 5, and 6 for radial bearings and height series 7, 9, 1, and 2 are for thrust bearings.	(3) Each thrust bearing diameter series has width series with number 7, 9, 1 and 2. Number 7 is the minimum width to the same bore and outside diameter. Number 2 is the maximum width.
Dimension series	Dimension series = width or height series number + Diameter series. Dimension series are labeled with a two digit number by combining numbers for the width or height series to the numbers for the diameter series. The two digit number has the width or height series in the lead position.	

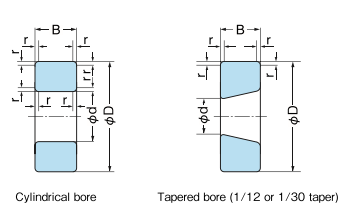

Fig 4.1 Radial Bearings (except Tapered Roller Bearings)

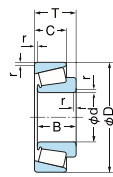

Fig 4.2 Tapered Roller Bearings

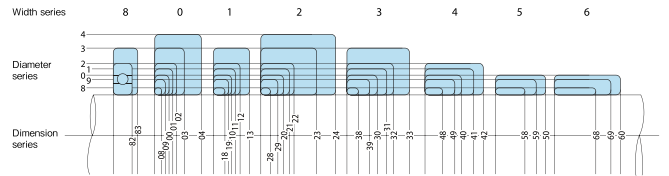

Fig 4.6 Graphical Representation of the Dimension series of Radial Bearings (except Tapered Roller Bearings)

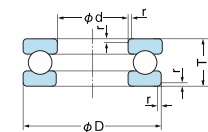

Fig 4.3 Single-direction Thrust Ball Bearings

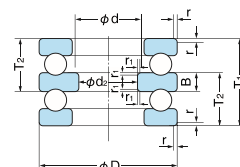

Fig 4.4 Double-direction Thrust Ball Bearings

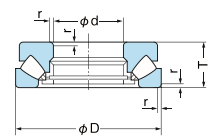

Fig 4.5 Spherical Roller Thrust Bearings

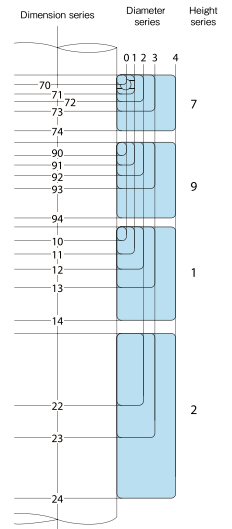

Fig 4.7 Graphical Representation of the Dimension series of Thrust Bearings (except diameter 5 series)

4.2 Boundary Dimensions of Radial Bearings (Except Tapered Roller Bearings)

Unit: mm

Bore No.	d	Diameter series 7		Diameter series 8					Diameter series 9					Diameter series 0						
		Width series		Width series		Width series		Width series		Width series		Width series		Width series		Width series		Width series		
		1	2	3	4	5	6	7	8	9	10	11	12	13	14	15	16	17	18	
		Dimension series		Dimension series		Dimension series		Dimension series		Dimension series		Dimension series		Dimension series		Dimension series		Dimension series		Dimension series
Single row radial ball bearings		67	68	69	70	71	72	73	74	75	76	77	78	79	80	81	82	83	84	85
Double row radial ball bearings		86	87	88	89	90	91	92	93	94	95	96	97	98	99	100	101	102	103	104
Cylindrical roller bearings		110	111	112	113	114	115	116	117	118	119	120	121	122	123	124	125	126	127	128
Tapered roller bearings		130	131	132	133	134	135	136	137	138	139	140	141	142	143	144	145	146	147	148

Remarks: 1. Chamfer dimensions (rmm) are the smallest allowable
 2. The chamfer dimensions given in this table do not necessarily apply to:
 (1) the outer rings of tapered roller bearings; (2) the flanges on the side of the cylindrical roller bearings; (3) the front face side of angular contact bearings; (4) inner rings of bearings with tapered bore

Table 4.2.2 Boundary Dimensions of Diameter Series 1, 2, 3, and 4

Table with columns for Bearing No., d, and various dimension series (1-4) for different bearing types like Double row radial ball bearings, Cylindrical roller bearings, Spherical roller bearings, etc. The table is organized into sections for different bearing types and series.

Remarks: 1. Chamfer dimensions (r) are the smallest allowable... 2. The chamfer dimensions (r) are the smallest allowable... 3. The chamfer dimensions (r) are the smallest allowable... 4. The chamfer dimensions (r) are the smallest allowable...

4.3 Boundary Dimensions of Tapered Roller Bearings

Table 4.3

Unit: mm

Table with columns for Bearing bore diameter Nominal, Bore No., d, and various diameter series (329, 320, 330, 331, 302, 322, 332, 303, 303D, 313, 323) including dimensions like D, B, C, T, r, and chamfer dimensions.

Remarks: 1. Chamfer dimensions (r(min)) are the smallest chamfer dimensions allowable. 2. Dimensions B, C, T of 32000 and 32200 series bearings without prefix E and suffix J listed on page 225 differ from the above dimensions.

Note: (*) To be applied to 303D series

4.4 Boundary Dimensions of Thrust Bearings with Flat Back Face

Table 4.4

Unit: mm

Table with columns for Bearing bore diameter Nominal, Dimension series 0, 1, 2, 3, 4, 5, and Bearing bore diameter Nominal. Rows list various bearing models and their dimensions.

Remark: Chamfer dimensions r(min) are the smallest chamfer dimensions allowable.

4.5 Dimensions of Snap Ring Grooves and Snap Rings

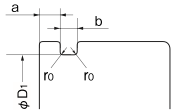

Table 4.5.1 Dimensions of Snap Ring Grooves for Bearing Dimension Series 18 and 19 Unit: mm

Nominal bearing outside diameter D	Snap ring groove diameter D ₁		Snap ring groove location a				Snap ring groove width b		Fillet radius at snap ring groove bottom r ₀	Applicable snap ring
			Dimension series 18		Dimension series 19					
	Max	Min	Max	Min	Max	Min	Max	Min	Max	
22	20.8	20.5	-	-	1.05	0.9	1.05	0.8	0.2	NR1022
24	22.8	22.5	-	-	1.05	0.9	1.05	0.8	0.2	NR1024
28	26.7	26.4	-	-	1.3	1.15	1.2	0.95	0.25	NR1028
30	28.7	28.4	-	-	1.3	1.15	1.2	0.95	0.25	NR1030
32	30.7	30.4	1.3	1.15	-	-	1.2	0.95	0.25	NR1032
34	32.7	32.4	1.3	1.15	-	-	1.2	0.95	0.25	NR1034
37	35.7	35.4	1.3	1.15	1.7	1.55	1.2	0.95	0.25	NR1037
39	37.7	37.4	-	-	1.7	1.55	1.2	0.95	0.25	NR1039
40	38.7	38.4	1.3	1.15	-	-	1.2	0.95	0.25	NR1040
42	40.7	40.4	1.3	1.15	1.7	1.55	1.2	0.95	0.25	NR1042
44	42.7	42.4	1.3	1.15	-	-	1.2	0.95	0.25	NR1044
45	43.7	43.4	-	-	1.7	1.55	1.2	0.95	0.25	NR1045
47	45.7	45.4	1.3	1.15	1.7	1.55	1.2	0.95	0.25	NR1047
52	50.7	50.4	1.3	1.15	1.7	1.55	1.2	0.95	0.25	NR1052
55	53.7	53.4	-	-	1.7	1.55	1.2	0.95	0.25	NR1055
58	56.7	56.4	1.3	1.15	-	-	1.2	0.95	0.25	NR1058
62	60.7	60.3	-	-	1.7	1.55	1.2	0.95	0.25	NR1062
65	63.7	63.3	1.3	1.15	-	-	1.2	0.95	0.25	NR1065
68	66.7	66.3	-	-	1.7	1.55	1.2	0.95	0.25	NR1068
72	70.7	70.3	1.7	1.55	1.7	1.55	1.2	0.95	0.25	NR1072
78	76.2	75.8	1.7	1.55	-	-	1.6	1.3	0.4	NR1078
80	77.9	77.5	-	-	2.1	1.9	1.6	1.3	0.4	NR1080
85	82.9	82.5	1.7	1.55	2.1	1.9	1.6	1.3	0.4	NR1085
90	87.9	87.5	1.7	1.55	2.1	1.9	1.6	1.3	0.4	NR1090
95	92.9	92.5	1.7	1.55	-	-	1.6	1.3	0.4	NR1095
100	97.9	97.5	1.7	1.55	2.5	2.3	1.6	1.3	0.4	NR1100
105	102.6	102.1	-	-	2.5	2.3	1.6	1.3	0.4	NR1105
110	107.6	107.1	2.1	1.9	2.5	2.3	1.6	1.3	0.4	NR1110
115	112.6	112.1	2.1	1.9	-	-	1.6	1.3	0.4	NR1115
120	117.6	117.1	2.1	1.9	3.3	3.1	1.6	1.3	0.4	NR1120
125	122.6	122.1	2.1	1.9	3.3	3.1	1.6	1.3	0.4	NR1125
130	127.6	127.1	2.1	1.9	3.3	3.1	1.6	1.3	0.4	NR1130
140	137.6	137.1	2.5	2.3	3.3	3.1	2.2	1.9	0.6	NR1140
145	142.6	142.1	-	-	3.3	3.1	2.2	1.9	0.6	NR1145
150	147.6	147.1	2.5	2.3	3.3	3.1	2.2	1.9	0.6	NR1150
165	161.8	161.3	3.3	3.1	3.7	3.5	2.2	1.9	0.6	NR1165
175	171.8	171.3	3.3	3.1	-	-	2.2	1.9	0.6	NR1175
180	176.8	176.3	-	-	3.7	3.5	2.2	1.9	0.6	NR1180
190	186.8	186.3	3.3	3.1	3.7	3.5	2.2	1.9	0.6	NR1190
200	196.8	196.3	3.3	3.1	-	-	2.2	1.9	0.6	NR1200

Remarks: Minimum allowable chamfer at groove side of outer ring by nominal bearing outside diameter are shown below.
 0.3 mm in dimension series 18 up to and including D = 78 mm, over D = 78 is 0.5 mm.
 0.3 mm in dimension series 19 up to and including D = 47 mm, over D = 47 is 0.5 mm.

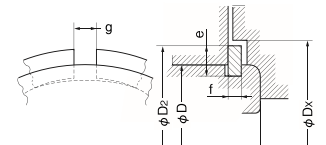

Table 4.5.2 Snap Ring Dimensions and Mounted Dimensions for Bearing Dimensions Series 18 and 19 Unit: mm

Snap ring No.	Snap ring dimensions				After snap ring mounting		Applicable Bearing			Diameter of end cover bore Dx (min)
	Section height e		Thickness f		Gap dimensions g	Outside diameter of snap ring D ₂ (max)	Nominal bearing outside diameter D	Dimension series		
	Max	Min	Max	Min				18	19	
NR1022	2.0	1.85	0.7	0.6	2	24.8	22	-	10	25.5
NR1024	2.0	1.85	0.7	0.6	2	26.8	24	-	12	27.5
NR1028	2.05	1.9	0.85	0.75	3	30.8	28	-	15	31.5
NR1030	2.05	1.9	0.85	0.75	3	32.8	30	-	17	33.5
NR1032	2.05	1.9	0.85	0.75	3	34.8	32	20	-	35.5
NR1034	2.05	1.9	0.85	0.75	3	36.8	34	22	-	37.5
NR1037	2.05	1.9	0.85	0.75	3	39.8	37	25	20	40.5
NR1039	2.05	1.9	0.85	0.75	3	41.8	39	-	22	42.5
NR1040	2.05	1.9	0.85	0.75	3	42.8	40	28	-	43.5
NR1042	2.05	1.9	0.85	0.75	3	44.8	42	30	25	45.5
NR1044	2.05	1.9	0.85	0.75	4	46.8	44	32	-	47.5
NR1045	2.05	1.9	0.85	0.75	4	47.8	45	-	28	48.5
NR1047	2.05	1.9	0.85	0.75	4	49.8	47	35	30	50.5
NR1052	2.05	1.9	0.85	0.75	4	54.8	52	40	32	55.5
NR1055	2.05	1.9	0.85	0.75	4	57.8	55	-	35	58.5
NR1058	2.05	1.9	0.85	0.75	4	60.8	58	45	-	61.5
NR1062	2.05	1.9	0.85	0.75	4	64.8	62	-	40	65.5
NR1065	2.05	1.9	0.85	0.75	4	67.8	65	50	-	68.5
NR1068	2.05	1.9	0.85	0.75	5	70.8	68	-	45	72
NR1072	2.05	1.9	0.85	0.75	5	74.8	72	55	50	76
NR1078	3.25	3.1	1.12	1.02	5	82.7	78	60	-	84
NR1080	3.25	3.1	1.12	1.02	5	84.4	80	-	55	86
NR1085	3.25	3.1	1.12	1.02	5	89.4	85	65	60	91
NR1090	3.25	3.1	1.12	1.02	5	94.4	90	70	65	96
NR1095	3.25	3.1	1.12	1.02	5	99.4	95	75	-	101
NR1100	3.25	3.1	1.12	1.02	5	104.4	100	80	70	106
NR1105	4.04	3.89	1.12	1.02	5	110.7	105	-	75	112
NR1110	4.04	3.89	1.12	1.02	5	115.7	110	85	80	117
NR1115	4.04	3.89	1.12	1.02	5	120.7	115	90	-	122
NR1120	4.04	3.89	1.12	1.02	7	125.7	120	95	85	127
NR1125	4.04	3.89	1.12	1.02	7	130.7	125	100	90	132
NR1130	4.04	3.89	1.12	1.02	7	135.7	130	105	95	137
NR1140	4.04	3.89	1.7	1.6	7	145.7	140	110	100	147
NR1145	4.04	3.89	1.7	1.6	7	150.7	145	-	105	152
NR1150	4.04	3.89	1.7	1.6	7	155.7	150	120	110	157
NR1165	4.85	4.7	1.7	1.6	7	171.5	165	130	120	173
NR1175	4.85	4.7	1.7	1.6	10	181.5	175	140	-	183
NR1180	4.85	4.7	1.7	1.6	10	186.5	180	-	130	188
NR1190	4.85	4.7	1.7	1.6	10	196.5	190	150	140	198
NR1200	4.85	4.7	1.7	1.6	10	206.5	200	160	-	208

Remarks: Minimum allowable chamfer at groove side of outer ring by nominal bearing outside diameter are shown below.
 0.3 mm in dimension series 18 up to and including D = 78 mm, over D = 78 is 0.5 mm.
 0.3 mm in dimension series 19 up to and including D = 47 mm, over D = 47 is 0.5 mm.

4.6 Rolling Contact Bearing Numbers

Table 4.6 Rolling Contact Bearing Numbers Configuration

Supplementary Prefix symbol		Basic No.				Supplementary Suffix symbol																										
Material symbols		Bearing Series Code		Bore Diameter Number		Contact Angle Code		Special Design Symbols		*Cage symbols		External feature		symbols		Combination symbols		*Sleeve symbols		Internal clearance symbols		Tolerance class symbols		Grease symbols								
Prefix	Description	Description	Description	Description	Suffix	Description	Suffix	Description	Suffix	Description	Suffix	Description	Suffix	Description	Suffix	Description	Suffix	Description	Suffix	Description	Suffix	Description	Suffix	Description								
B-	Case hardened steel	68 Single row Deep-groove Ball Bearings	1	Diameter 1 mm	A	Inner ring width variation for tapered roller bearing	F	With machined mild steel cage	ZE	Shield one side	K	Bearing diameter 1/12 Taper	DB	Back-to-back mounting	+H	Adapter sleeve	C1	Radial clearance C1	(O)	JIS class 0	(AV2)	Shell Alvania grease No. 2										
		60	2	2	C	Nominal contact angle over 10° under 22° (standard 15°)	G	Non-metallic cage	Z	Shield one side	DF	Face-to-face mounting	+AH	Withdrawal sleeve	C2	Radial clearance C2	P6	JIS class 6	BC325	Eso Beacon 325												
C-	Case hardened steel	70 Single row Angular Contact Ball Bearings	9	9	E	Roller bearing design change	L	Machined light alloy cage	ZZE	Shield both sides	K30	Bearing diameter 1/30 Taper	DT	Tandem mounting	C3	Radial clearance C3	P5	JIS class 5	MTSRL	Multemp SRL												
D-	Case hardened steel	73 Contact Ball Bearings	01	12	(A)	Nominal contact angle over 22° under 32° (standard 30°)	J	Tapered roller bearing inner and outer rings internationally interchangeable	MY	Machined bronze cage	N	Snap ring groove on outer ring	KB	DB mounting with spacer to outer ring	C4	Radial clearance C4	P4	JIS class 4	PS2	Multemp PS2												
H-	High speed steel	12 Self-Aligning Ball Bearings	04	20	B	Nominal contact angle over 32° under 45° (standard 40°)	S26	Heat stabilization treatment	Y	Pressed non-metallic cage	NR	Snap ring groove and snap ring on outer ring	+α	Spacer (+α is nominal width in mm)	C5	Radial clearance C5	UP	NACHI class UP														
S-	Stainless steel	NU 10 Cylindrical Roller Bearings	06	30	D	Nominal contact angle over 24° under 32°	W20	Oil holes in outer ring	-2NKE	Labyrinth seal both sides	DU	Flush ground ball bearing	C1P	Radial clearance C1P (extra small ball bearings and miniature ball bearings)	C2P	C2P (extra small ball bearings and miniature ball bearings)	C6P	C6P (extra small ball bearings and miniature ball bearings)	C9na	Cylindrical roller bearing non-interchangeable clearance C9	C1na	Cylindrical roller bearing non-interchangeable clearance C1	C2na	Cylindrical roller bearing non-interchangeable clearance C2	CM	Deep groove ball bearings and non-interchangeable clearance of cylindrical roller bearings for electric motors	CT	Interchangeable clearance of cylindrical roller bearings for electric motors				
		N 3	07	35	D	Nominal contact angle over 24° under 32°	W33	Oil holes and grooves in outer ring	-2NKE	Labyrinth seal both sides																						
		NN 30	08	40	D	Nominal contact angle over 24° under 32°	W33	Oil holes and grooves in outer ring	-2NKE	Labyrinth seal both sides																						
		NA48 Needle Roller Bearings	88	440	C	Nominal contact angle over 17° under 24°	E2	Spherical roller bearing with machined cage	-2NKE	Labyrinth seal both sides																						
		NA49 Roller Bearings	92	460			EX	High capacity spherical roller bearing	-2NKE	Labyrinth seal both sides																						
		NA69	96	480			A2X	High speed spherical roller bearing	-2NKE	Labyrinth seal both sides																						
		320 Tapered Roller Bearings	/500	500			AEX	High speed and high capacity spherical roller bearing																								
		322	/530	530			V	Special design for vibrating machine																								
		323	/560	560																												
		230 Spherical Roller Bearings																														
		222																														
		223																														
		511 Flat Back Face Thrust Ball Bearings																														
		512																														
		513																														
		292 Spherical Roller Bearings																														
		293																														
		294																														

Note: (°) Denotes polyamide for angular contact ball bearing of contact angle symbol C.
 Remarks: 1. Symbols in parentheses can be omitted.
 2. Symbols marked with an "*" are not marked on the bearings.
 3. Bearing modification symbol NR is marked without R on the bearings.

NACHI Rolling Contact Bearing Numbers ...Examples

The NACHI part number for rolling contact bearings consists of the basic number and supplementary codes. The part number defines the bearing configuration, tolerance, general boundary dimensions, and other

specifications. NACHI uses supplemental prefix and suffix symbols as shown in Table 4.6. The NACHI basic number consists of the following:

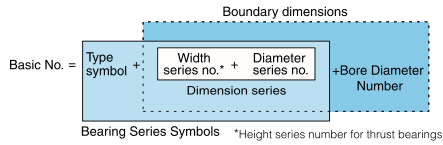

Bore Diameter number	
Bore (mm)	4 5 6 7 8 9 10 12 15 17 20 25 ... 480 500 530 ...
Bore diameter number	4 5 6 7 8 9 00 01 02 03 04 05 ... 96/500/530 ...
Remarks	Bore Diameter (bore dia.)/5 /bore diameter

Example 1

6 2 04 ZZE C3 P6

- Tolerance symbol (JIS class 6)
- Internal clearance symbol (C3)
- Shields (2 shields)
- Bore diameter number (20 mm)
- Diameter series no. (series 2)
- Type symbol (Single row deep groove ball bearing)

Example 3

2 3 0 34 E W33 K

- Ring modification symbol (1/12 tapered bore)
- Special design symbol (Oil hole and groove in outer ring)
- Special design symbol (improvement)
- Bore diameter number (170 mm)
- Diameter series no. (series 0)
- Width series number (Series 3)
- Type symbol (Spherical Roller Thrust Bearings)

Example 2

7 2 10 C Y DB /GL P4

- Tolerance symbol (JIS class 4)
- Internal clearance symbol (Light preload)
- Duplex mounting (Back-to-back)
- Cage symbol (Polyamide cage)
- Contact angle symbol (15° angle)
- Bore diameter number (50 mm)
- Diameter series no. (series 2)
- Type symbol (Single row angular contact ball bearing)

Example 4

5 1 2 08

- Bore diameter number (40 mm)
- Diameter series no. (series 2)
- Height series (Series 1)
- Type symbol (Thrust ball bearing)

5. Accuracy of Rolling Contact Bearings

The tolerance of rolling contact bearings includes dimensional and running accuracy. According to JIS (Japanese Industrial Standard), tolerance is classified into 6 classes; class 0, 6X, 5, 4 and 2 with accuracy ascending from

class 0 to 2. Applicable tolerance classes to individual bearing types and applicable standards are shown in the table below.

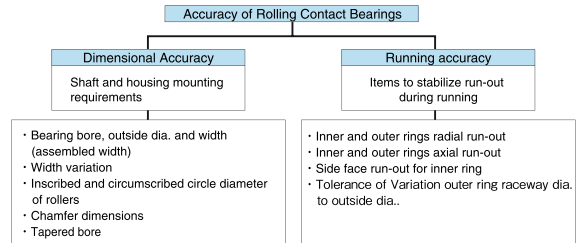

Bearing types and tolerance classes

Bearing Type	Tolerance class					Related Standard	Reference Tables
Deep Groove Ball Bearings	JIS class 0	JIS class 6	JIS class 5	JIS class 4	JIS class 2	JIS B 1514	Table 5.1.1
Miniature Ball Bearings	JIS class 0	JIS class 6	JIS class 5	JIS class 4	JIS class 2	JIS B 1514	Table 5.1.2
Extra Small Ball Bearings	Instrument	—	ISO/A	ISO/A	—	ISO 1224	—
Angular Contact Ball Bearings	JIS class 0	JIS class 6	JIS class 5	JIS class 4	JIS class 2	ANSI Std 12.2	—
Self-Aligning Ball Bearings	JIS class 0	—	—	—	—	JIS B 1514	Table 5.1.1 Table 5.1.2
Cylindrical Roller Bearings	JIS class 0	JIS class 6	JIS class 5	JIS class 4	JIS class 2	—	—
Spherical Roller Bearings	JIS class 0	—	—	—	—	JIS B 1514	Table 5.2.1 to 5.2.3
Tapered Roller Bearings	Metric Series: JIS class 0, JIS class 6X	JIS class 6	JIS class 5	JIS class 4	—	ANSI / ABMA 19	Table 5.5.1 to 5.5.4
Thrust Ball Bearings	JIS class 0	JIS class 6	JIS class 5	JIS class 4	—	JIS B 1514	Table 5.3.1 to 5.3.3
Spherical Roller Thrust Bearings	JIS class 0	—	—	—	—	JIS B 1514	Table 5.4.1, 5.4.2

Metric Radial Bearings (Except Tapered Roller Bearings) Class Comparison

Bearing Type	ISO ⁽¹⁾	Tolerance class					Related Standard	Reference Tables
		NORMAL CLASS	CLASS 6	CLASS 5	CLASS 4	CLASS 2		
Comparative Classes (Reference)	DIN ⁽²⁾	P0	P6	P5	P4	P2	ISO 492 etc.	—
	ANSI ⁽³⁾ / ABMA ⁽⁴⁾	ABEC 1	ABEC 3	ABEC 5	ABEC 7	ABEC 9	ANSI / ABMA 20	—
		RBEC 1	RBEC 3	RBEC 5	—	—	ANSI / ABMA 20	—

Notes: (1) ISO International Standard (2) German Industrial Standards (3) American National Standards Institute (4) American Bearing Manufacturers Association
Remark: For tolerances of chamfer dimensions, see Table 5.6.1 to 5.6.3; for accuracy of tapered bore, see Table 5.7.1 to 5.7.2.

5.3 Tolerance Values for Thrust Ball Bearings

Table 5.3.1 Tolerance Values of Shaft Washer Bore Diameter

Unit: μm

Nominal bearing bore diameter d or d _s (mm)	Single plane mean bore diameter deviation Δd _{mp} or Δd _{mp} s					Bore diameter variation, in a single radial plane V _d or V _d s			Washer thickness (raceway to back face or raceway) variation (°) S ₁ or S ₂			
	Over	Incl.	High	Low	Class 4	Max	Max	Max	Class 0	Class 5	Class 4	Class 4
18	0	-8	0	-7	6	5	10	5	3	2		
30	0	-10	0	-8	8	6	10	5	3	2		
50	0	-12	0	-10	9	8	10	6	3	2		
80	0	-15	0	-12	11	9	10	7	4	3		
120	0	-20	0	-15	15	11	15	8	4	3		
180	0	-25	0	-18	19	14	15	9	5	4		
250	0	-30	0	-22	23	17	20	10	5	4		
315	0	-35	0	-25	26	19	25	13	7	5		
400	0	-40	0	-30	30	23	30	15	7	5		
500	0	-45	0	-35	34	26	30	18	9	6		
630	0	-50	0	-40	38	30	35	21	11	7		
800	0	-55	0	-45	40	35	40	25	13	8		
1000	0	-60	0	-50	45	30	50	30	15	—		
1250	0	-65	0	-55	50	35	60	35	18	—		

Note: (°) For double acting bearings, do not use d_s; use size classification d for the same diameter series and same outside diameter. Variation S₁ for outer ring washer thickness applies to flat seat bearings only.

Table 5.3.3 Height Tolerances of Thrust Ball Bearings (with Flat Seat) and Central Washers (Class 0)

Unit: μm

Nominal bearing bore diameter d (mm)	Deviation of single height, T ₁		Deviation of single height, T ₂ of double direction thrust bearing (°)		Deviation of single height, T ₁ of double direction thrust bearing (°)		Deviation of center washer height T ₁ (°)	
	Over	Incl.	High	Low	High	Low	Max	Max
30	0	30	0	-75	0	-75	+50	-150
50	0	50	0	-100	0	-100	+75	-200
80	0	80	0	-125	0	-125	+100	-250
120	0	120	0	-150	0	-150	+125	-300
180	0	180	0	-175	0	-175	+150	-350
250	0	250	0	-200	0	-200	+175	-400
315	0	315	0	-225	0	-225	+200	-450
400	0	400	0	-300	0	-300	+250	-600

Note: (°) For the same diameter series, use size classification single-direction d for the same nominal bearing outside diameter.

5.4 Tolerance Values of Spherical Roller Thrust Bearings (Class 0)

Table 5.4.1 Tolerance Values of Inner Rings

Unit: μm

Nominal bearing bore diameter d (mm)	Single plane mean bore diameter deviation Δd _{mp}			Bore diameter variation, in a single radial plane V _d	Inner ring reference face runout with bore S _i	Deviation of single height ΔTs	
	Over	Incl.	High			Low	Max
50	0	-15	11	25	+150	-150	
80	0	-20	15	25	+200	-200	
120	0	-25	19	30	+250	-250	
180	0	-30	23	30	+300	-300	
250	0	-35	26	35	+350	-350	
315	0	-40	30	40	+400	-400	
400	0	-45	34	45	+450	-450	

Remark: The high deviation of inside diameter of bearings does not apply within a distance from the ring face of 1.2 x r (max) of the chamfer.

Table 5.4.2 Tolerance Values of Outer Rings

Unit: μm

Nominal bearing bore diameter d (mm)	Outer diameter deviation ΔD _{mp}		
	Over	Incl.	High
120	180	0	-25
180	250	0	-30
250	315	0	-35
315	400	0	-40
400	500	0	-45
500	630	0	-50
630	800	0	-75
800	1000	0	-100

Remark: The low deviation of outside diameter of bearings does not apply within a distance from the ring face of 1.2 x r (max) of the chamfer.

5.5 Tolerance Values of Tapered Roller Bearings - Inch Series

Table 5.5.1 Tolerance of Inner Ring (Cone) Bore

Unit: μm

Nominal bearing bore diameter d mm (inch)	Deviation of single bore diameter Δds							
	CLASS 4		CLASS 3		CLASS 0		CLASS 00	
	High	Low	High	Low	High	Low	High	Low
—	+13		0		+13		0	
76.200 (3)	+25		0		+13		0	
266.700 (10.5)	+25		0		+13		0	
304.800 (12)	+51		0		+25		0	
609.600 (24)	+76		0		+38		0	
914.400 (36)	+102		0		+51		0	
1219.200 (48)	+127		0		+76		0	

Table 5.5.2 Tolerance of Outer Ring (Cup) Outside Diameter

Unit: μm

Nominal bearing outside diameter D mm (inch)	Deviation of single outside diameter ΔDs							
	CLASS 4		CLASS 3		CLASS 0		CLASS 00	
	High	Low	High	Low	High	Low	High	Low
—	+25		0		+13		0	
266.700 (10.5)	+25		0		+13		0	
304.800 (12)	+51		0		+25		0	
609.600 (24)	+76		0		+38		0	
914.400 (36)	+102		0		+51		0	
1219.200 (48)	+127		0		+76		0	

Table 5.5.3 Tolerance of Bearing Width and Duplex/Stack Mounted Bearing Width (°)

Unit: μm

Nominal bearing bore diameter d mm (inch)	Nominal bearing outside diameter D mm (inch)	Deviation of the actual bearing width Δrs							
		CLASS 4		CLASS 3		CLASS 0		CLASS 00	
		High	Low	High	Low	High	Low	High	Low
—	+203		0		+203		-203		
101.600 (4)	+256		-254		+203		-203		
266.700 (10.5)	+356		-254		+203		-203		
304.800 (12)	+381		-381		+381		-381		
304.800 (12)	+381		-381		+381		-381		
609.600 (24)	+381		-381		+381		-381		

Note: (°) Deviation of the mounted width B_s and C₂ four row tapered roller bearing is ±1524 μm for the tolerance classes of 4,3 and 0.

Table 5.5.4 Radial Runout of Assembled Bearing Inner Ring and Outer Ring

Unit: μm

Nominal bearing outside diameter D mm (inch)	Radial runout of assembled bearing inner ring, K _{ea} and of assembled bearing outer ring, K _{oa} (MAX)			
	CLASS 4		CLASS 3	
	High	Low	High	Low
—	51		8	
266.700 (10.5)	51		8	
304.800 (12)	51		18	
609.600 (24)	76		51	
914.400 (36)	76		76	

5.6 Chamfer Dimension Limits

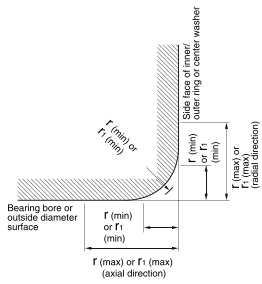

r : Chamfer dimensions of inner ring and outer ring
 r1: Chamfer dimensions of inner ring and outer ring (front face etc.) or of center ring of thrust ball bearing

Remark: The exact shape of the chamfer surface is not specified, but its contour in an axial plane shall not be allowed to project beyond the imaginary circular arc, of radius r min, tangential to the ring face and the bore or outside cylindrical surface of the ring (see figure).

Table 5.6.1 Chamfer Dimension Limits of Radial Bearings Except Tapered Roller Bearings Unit: mm

Smallest permissible chamfer dimensions of inner and outer rings r (min) or r1 (min)	Nominal bearing bore diameter d		Largest permissible chamfer dimensions of inner and outer rings r (max) or r1 (max)		Reference Shaft and housing fillet radius ra Max
	Over	Incl.	Radial direction	Axial direction	
0.05	—	—	0.1	0.2	0.05
0.08	—	—	0.16	0.3	0.08
0.1	—	—	0.2	0.4	0.1
0.15	—	—	0.3	0.6	0.15
0.2	—	—	0.5	0.8	0.2
0.3	—	40	0.6	1	0.3
	40	—	0.8	1	
0.6	—	40	1.5	2	0.6
	40	—	1.3	2	
1	—	50	1.5	3	1
	50	—	1.9	3	
1.1	—	120	2	3.5	1
	120	—	2.5	4	
1.5	—	120	2.3	4	1.5
	120	—	3	5	
2	—	80	3	4.5	2
	80	220	3.5	5	
2.1	—	280	4	6.5	2
	280	—	4.5	7	
2.5	—	100	3.8	6	2
	100	280	4.5	6	
3	—	280	5	8	2.5
	280	—	5.5	8	
4	—	—	6.5	9	3
5	—	—	8	10	4
6	—	—	10	13	5
7.5	—	—	12.5	17	6
9.5	—	—	15	19	8
12	—	—	18	24	10
15	—	—	21	30	12
19	—	—	25	38	15

Remark: For bearings with nominal width 2 mm or less, r (max) values in the axial direction of the bearing are the same as for the radial direction.

Table 5.6.2 Chamfer Dimensions Limits of Tapered Roller Bearings Unit: mm

Smallest permissible chamfer dimensions of inner and outer rings r (min)	Bearing bore diameter or outside diameter (*) d or D		Largest permissible chamfer dimensions of inner and outer rings r (max)		Reference Shaft and housing fillet radius ra Max
	Over	Incl.	Radial direction	Axial direction	
0.3	—	40	0.7	1.4	0.3
	40	—	0.9	1.6	
0.6	—	40	1.1	1.7	0.6
	40	—	1.3	2	
1	—	50	1.6	2.5	1
	50	—	1.9	3	
1.5	—	120	2.3	3	1.5
	120	250	2.8	3.5	
250	—	3.5	4		
2	—	120	2.8	4	2
	120	250	3.5	4.5	
250	—	4	5		
2.5	—	120	3.5	5	2
	120	250	4	5.5	
250	—	4.5	6		
3	—	120	4	5.5	2.5
	120	250	4.5	6.5	
250	400	—	5	7	
400	—	5.5	7.5		
4	—	120	5	7	3
	120	250	5.5	7.5	
250	400	—	6	8	
400	—	6.5	8.5		
5	—	180	6.5	8	4
	180	—	7.5	9	
6	—	180	7.5	10	5
	180	—	9	11	

Note: (*) d and D are applied to inner ring and outer ring respectively.

Table 5.6.3 Chamfer Dimension Limits of Thrust Bearings Unit: mm

Smallest permissible chamfer dimensions of inner and outer rings r (min) or r1 (min)	Largest permissible single chamfer dimensions of inner and outer rings r (max) or r1 (max)		Reference Shaft and housing fillet radius ra Max
	Radial direction	Axial direction	
0.05	0.1	0.05	
0.08	0.16	0.08	
0.1	0.2	0.1	
0.15	0.3	0.15	
0.2	0.5	0.2	
0.3	0.8	0.3	
0.6	1.5	0.6	
1	2.2	1	
1.1	2.7	1	
1.5	3.5	1.5	
2	4	2	
2.1	4.5	2	
3	5.5	2.5	
4	6.5	3	
5	8	4	
6	10	5	
7.5	12.5	6	
9.5	15	8	
12	18	10	
15	21	12	
19	25	15	

5.7 Tolerances for Tapered Bores

- d : Bearing bore diameter, nominal
- d1: Bore diameter at the theoretical large end of a tapered bore
 in case of 1/12 taper $d1=d+1/12B$
 in case of 1/30 taper $d1=d+1/30B$
- Δd_{mp} : Mean bore diameter deviation at theoretical small end of a tapered bore
- Δd_{mp} : Mean bore diameter deviation at theoretical large end of a tapered bore
- B: Bearing inner ring width, nominal
- α : Nominal taper angle (half of cone angle)
 in case of 1/12 taper $\alpha=2^{\circ}23'9.4''$
 $=2.38594^{\circ}$
 $=0.041643$ rad
- in case of 1/30 taper $\alpha=0^{\circ}57'17.4''$
 $=0.95484^{\circ}$
 $=0.016665$ rad

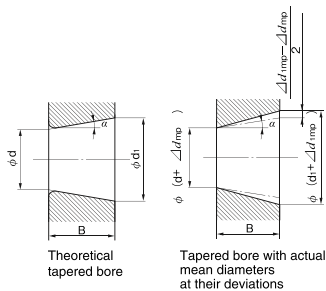

Table 5.7.1 1/12 Tapered Bore (Class 0) Unit: μm

Nominal bearing bore dimension d (mm)	Incl.	Mean bore diameter deviation at theoretical small end of a tapered bore				Bore diameter variation in a single radial plane Vd_0 (1) (2)
		Δd_{mp}		$\Delta d_{mp} - \Delta d_{mp}$		
		High	Low	High	Low	
10	18	+22	0	+15	0	9
18	30	+27	0	+18	0	11
		+33	0	+21	0	13
30	50	+39	0	+25	0	16
50	80	+46	0	+30	0	19
80	120	+54	0	+35	0	22
120	180	+63	0	+40	0	40
180	250	+72	0	+46	0	46
250	315	+81	0	+52	0	52
315	400	+89	0	+57	0	57
400	500	+97	0	+63	0	63
500	630	+110	0	+70	0	70
630	800	+125	0	+80	0	—
800	1000	+140	0	+90	0	—
1000	1250	+165	0	+105	0	—
1250	1600	+195	0	+125	0	—

Notes: (1) Applicable to all radial planes of tapered bore.
 (2) Not applicable to bearings of diameter series 7 and 8.

Table 5.7.2 1/30 Tapered Bore (Class 0) Unit: μm

Nominal bearing bore dimension d (mm)	Incl.	Mean bore diameter deviation at theoretical small end of a tapered bore				Bore diameter variation in a single radial plane Vd_0 (1) (2)
		Δd_{mp}		$\Delta d_{mp} - \Delta d_{mp}$		
		High	Low	High	Low	
50	80	+15	0	+30	0	19
80	120	+20	0	+35	0	22
120	180	+25	0	+40	0	40
180	250	+30	0	+46	0	46
250	315	+35	0	+52	0	52
315	400	+40	0	+57	0	57
400	500	+45	0	+63	0	63
500	630	+50	0	+70	0	70

Notes: (1) Applicable to all radial planes of tapered bores.
 (2) Not applicable to bearings of diameter series 7 and 8.

6. Internal Clearance of Rolling Contact Bearings

Bearing internal clearance refers to the distances between the bearing rings and rolling elements as shown in Fig. 6.1 and Fig. 6.2. The amount of alternating radial movement of the free bearing rings is defined as radial clearance, and the amount of alternating axial movement of the free bearing rings is defined as axial clearance.

The term internal clearance refers to a state where no force is applied to the bearing rings and rolling elements, i.e., an unloaded state.

Since a stabilizing, measuring load is applied to bearings when measuring the internal clearance, some elastic deformation occurs to the bearing rings and rolling elements, and the measured internal clearance will be larger than the real clearance by the value of deformation. The amount of elastic deformation caused by the measuring load may be disregarded for roller bearings, but must be compensated for when measuring ball bearing clearance because it will skew the internal clearance measurement.

Internal clearance values are described in the JIS (ISO) and the Japan Bearing Industrial Association Standards (BAS) as follows:

- Deep-groove ball bearings
- Self-aligning ball bearings
- Cylindrical roller bearings
- Spherical roller bearings
- For electric motor
 - Deep-groove ball bearings
 - Cylindrical roller bearings

JIS B1520 (ISO 5753)

BAS 1003

Bearings not covered by either JIS (ISO) or BAS are standardized by NACHI. Tables 6.1 through 6.6 show internal clearance values for NACHI bearings.

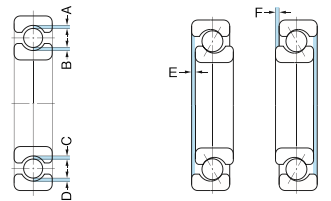

Fig 6.1 Radial internal clearance = A+B+C+D

Fig 6.2 Axial internal clearance = E+F

Table 6.1 Radial Internal Clearance of Deep Groove Ball Bearings (JIS) Unit: μm

Nominal bearing bore diameter d (mm)	Radial Clearance									
	C2		CN (normal)		C3		C4		C5	
Over	Incl.	Min	Max	Min	Max	Min	Max	Min	Max	
2.5	6	0	7	2	13	8	23	—	—	
6	10	0	7	2	13	8	23	14	29	
10	18	0	7	2	13	8	23	18	33	
18	24	0	10	5	20	13	28	20	36	
24	30	1	11	5	20	13	28	23	41	
30	40	1	11	6	20	15	33	28	46	
40	50	1	11	6	23	18	36	30	51	
50	65	1	15	8	28	23	43	38	61	
65	80	1	15	10	30	25	51	46	71	
80	100	1	18	12	36	30	58	53	84	
100	120	2	20	15	41	36	66	61	97	
120	140	2	23	18	48	41	81	71	114	
140	160	2	23	18	53	46	91	81	130	
160	180	2	25	20	61	53	102	91	147	
180	200	2	30	25	71	63	117	107	163	
200	225	2	35	25	85	75	140	125	195	
225	250	2	40	30	95	85	160	145	225	
250	280	2	45	35	105	90	170	155	245	
280	315	2	55	40	115	100	190	175	275	
315	355	3	60	45	125	110	210	195	300	
355	400	3	70	55	145	130	240	225	340	
400	450	3	80	60	170	150	270	250	380	
450	500	3	90	70	190	170	300	280	420	
500	560	10	100	80	210	190	330	310	470	
560	630	10	110	90	230	210	360	340	520	
630	710	20	130	110	260	240	400	380	570	
710	800	20	140	120	290	270	450	430	630	
800	900	20	160	140	320	300	500	480	700	
900	1000	20	170	150	350	330	550	530	770	
1000	1120	20	180	160	380	360	600	580	820	
1120	1250	20	190	170	410	390	650	630	890	

Table 6.2 Radial Internal Clearance of Self-aligning Ball Bearings (JIS) Unit: μm

Nominal bearing bore diameter d (mm)	Radial clearance (cylindrical bore)										Radial clearance (tapered bore)										
	C2		CN (normal)		C3		C4		C5		C2		CN (normal)		C3		C4		C5		
Over	Incl.	Min	Max	Min	Max	Min	Max	Min	Max	Min	Max	Min	Max	Min	Max	Min	Max	Min	Max	Min	Max
2.5	6	1	8	5	15	10	20	15	25	21	33	—	—	—	—	—	—	—	—	—	—
6	10	2	9	6	17	12	25	19	33	27	42	—	—	—	—	—	—	—	—	—	—
10	14	2	10	6	19	13	26	21	35	30	48	—	—	—	—	—	—	—	—	—	—
14	18	3	12	8	21	15	28	23	37	32	50	—	—	—	—	—	—	—	—	—	—
18	24	4	14	10	23	17	30	25	39	34	52	7	17	13	26	20	33	28	42	37	55
24	30	5	16	11	24	19	35	29	46	40	58	9	20	15	28	23	39	33	50	44	62
30	40	6	18	13	29	23	40	34	53	46	66	12	24	19	35	29	46	40	59	52	72
40	50	6	19	14	31	25	44	37	57	50	71	14	27	22	39	33	52	45	65	58	79
50	65	7	21	16	36	30	50	45	69	62	88	18	32	27	47	41	61	56	80	73	99
65	80	8	24	18	40	35	60	54	83	76	108	23	39	35	57	50	75	69	98	91	123
80	100	9	27	22	48	42	70	64	96	89	124	29	47	42	68	62	90	84	116	109	144
100	120	10	31	25	56	50	83	75	114	105	145	35	56	50	81	75	108	100	139	130	170
120	140	10	38	30	68	60	100	90	135	125	175	40	68	60	98	90	130	120	165	155	205
140	160	15	44	35	80	70	120	110	161	150	210	45	74	65	110	100	150	140	191	180	240

Table 6.3 Radial Internal Clearance of Cylindrical Roller Bearings

Table 6.3.1 Radial Internal Clearance of Cylindrical Roller Bearings (Cylindrical Bore) (JIS) Unit: μm

Nominal bearing bore diameter d (mm)	Radial clearance										
	C2		CN (normal)		C3		C4		C5		
Over	Incl.	Min	Max	Min	Max	Min	Max	Min	Max	Min	Max
—	10	0	25	20	45	35	60	50	75	—	—
10	24	0	25	20	45	35	60	50	75	65	90
24	30	0	25	20	45	35	60	50	75	70	95
30	40	5	30	25	50	45	70	60	85	80	105
40	50	5	35	30	60	50	80	70	100	95	125
50	65	10	40	40	70	60	90	80	110	110	140
65	80	10	45	40	75	65	100	90	125	130	165
80	100	15	50	50	85	75	110	105	140	155	190
100	120	15	55	50	90	85	125	125	165	180	220
120	140	15	60	60	105	100	145	145	190	200	245
140	160	20	70	70	120	115	165	165	215	225	275
160	180	25	75	75	125	120	170	170	220	250	300
180	200	35	90	90	145	140	195	195	250	275	330
200	225	45	105	105	165	160	220	220	280	305	365
225	250	45	110	110	175	170	235	235	300	330	395
250	280	55	125	125	195	190	260	260	330	370	440
280	315	55	130	130	205	200	275	275	350	410	485
315	355	65	145	145	225	225	305	305	385	455	535
355	400	100	190	190	280	280	370	370	460	510	600
400	450	110	210	210	310	310	410	410	510	565	665
450	500	110	220	220	330	330	440	440	550	625	735

Table 6.3.2 Non-interchangeable Radial Internal Clearance of Cylindrical Roller Bearings (Tapered Bore) (NACHI) Unit: μm

Nominal bearing bore diameter d (mm)	Radial clearance						
	C9na		C1na		C2na		
Over	Incl.	Min	Max	Min	Max	Min	Max
14	18	5	10	10	20	20	30
18	24	5	10	10	20	20	30
24	30	5	10	15	25	25	35
30	40	5	12	15	25	25	40
40	50	5	15	17	30	30	45
50	65	5	15	20	35	35	50
65	80	10	20	25	40	40	60
80	100	10	25	35	55	55	70
100	120	10	25	40	60	60	80
120	140	15	30	45	70	70	90
140	160	15	35	50	75	75	100
160	180	15	35	55	85	75	110
180	200	20	40	60	90	80	120
200	225	20	45	60	95	90	135
225	250	25	50	65	100	100	150
250	280	25	55	75	110	110	165
280	315	30	60	80	120	120	180
315	355	30	65	90	135	135	200
355	400	35	75	100	150	150	225
400	450	40	85	110	170	170	255
450	500	45	95	120	190	190	285

Remark: Shown for reference because JIS has not standardized non-interchangeable radial clearance for tapered bore bearings.

7. Materials for Rolling Contact Bearings

A rolling contact bearing consist of one or more rings and rolling elements (which directly support the loads) and, usually, a cage which keeps the rolling elements at equal intervals. Both rolling and sliding movements occur between these parts.

7.1 Bearing Ring and Rolling Elements

Because of high, repetitive stress to the rolling contact areas, fatigue phenomenon will occur to the bearing material after a duration of operation. Loading stress ultimately dislodges a surface section and the bearing fails. To delay the advent of material fatigue, bearing ring and rolling element materials should have the following properties:

- High level of hardness
- High rolling contact fatigue resistance
- Good wear resistance
- Dimensional stability
- Good mechanical strength

Standard NACHI material for bearing rings and rolling elements is vacuum-degassed, high-carbon, chrome bearing steel. See Table 7.1. For applications requiring a higher degree of reliability, bearing steel using a vacuum-melting process or electroslag solution (ERS).

The NACHI steel used for standard bearings is SUJ2 (JIS) steel. For large size bearings, SUJ3 or SUJ5 steels are used for hardenability. If impact resistance is required, SNCM series steel may be used (see Table 7.2). In addition to the above, high-speed steel may

be used for bearings for applications requiring tolerance to high temperatures. Stainless steel may be used for bearings operating in a corrosive atmosphere. Ceramic materials may be used for special applications.

7.2 Cage Material

Materials for cages are required to have the following properties:

- Good wear resistance
- Dimensional stability
- Good mechanical strength

Cold-rolled steel (see Table 7.5) is used for pressed cages. High-tensile-strength brass castings or carbon steel are used for machined cages (see Tables 7.6 and 7.7). Polyamide resins are used depending on the type of bearing and the application.

For selection of cage material, it is important to consider the operating conditions.

Polyamide cages should not be used at temperatures above 120°C or below -40°C.

Polyamide cages should not be used in vacuum because they become brittle due to dehydration.

Polyamide cages may be affected by the use of specific lubricants.

Brass cages should not be used at temperatures in excess 300°C.

Brass cages are not suitable in Ammonia (e.g. in refrigeration) because Ammonia causes season cracking in brass.

Table 7.1 High Carbon Chrome Bearing Steel

Standard	Symbol	Chemical composition (%)						
		C	Si	Mn	P	S	Cr	Mo
JIS	SUJ 2	0.95~1.10	0.15~0.35	≤ 0.50	≤ 0.025	≤ 0.025	1.30~1.60	≤ 0.08
	SUJ 3	0.95~1.10	0.40~0.70	0.90~1.15	≤ 0.025	≤ 0.025	0.90~1.20	≤ 0.08
	SUJ 4	0.95~1.10	0.15~0.35	≤ 0.50	≤ 0.025	≤ 0.025	1.30~1.60	0.10~0.25
	SUJ 5	0.95~1.10	0.40~0.70	0.90~1.15	≤ 0.025	≤ 0.025	0.90~1.20	0.10~0.25
SAE	52100	0.98~1.10	0.15~0.35	0.25~0.45	≤ 0.025	≤ 0.025	1.30~1.60	≤ 0.10

Table 7.2 Case Hardening Steel

Standard	Symbol	Chemical composition (%)							
		C	Si	Mn	P	S	Ni	Cr	Mo
JIS	SNCM220	0.17~0.23	0.15~0.35	0.60~0.90	≤ 0.030	≤ 0.030	0.40~0.70	0.40~0.60	0.15~0.25
	SNCM420	0.17~0.23	0.15~0.35	0.40~0.70	≤ 0.030	≤ 0.030	1.60~2.00	0.40~0.60	0.15~0.30
	SNCM815	0.12~0.18	0.15~0.35	0.30~0.60	≤ 0.030	≤ 0.030	4.00~4.50	0.70~1.00	0.15~0.30
SAE	8620	0.18~0.23	0.15~0.35	0.60~0.90	≤ 0.030	≤ 0.030	—	0.90~1.20	—
	4320	0.17~0.22	0.15~0.35	0.45~0.65	≤ 0.035	≤ 0.040	1.65~2.00	0.40~0.60	0.20~0.30
	4340	0.17~0.22	0.15~0.35	0.45~0.65	≤ 0.035	≤ 0.040	1.65~2.00	0.40~0.60	0.20~0.30

Table 7.3 High-Speed Steel

Standard	Symbol	Chemical composition (%)											
		C	Si	Mn	P	S	Cr	Mo	V	Ni	Cu	Co	W
AISI	M50	0.77~0.85	≤ 0.25	≤ 0.35	≤ 0.015	≤ 0.015	3.75~4.25	4.00~4.50	0.90~1.10	≤ 0.15	≤ 0.10	≤ 0.25	≤ 0.25

Table 7.4 Stainless Steel

Standard	Symbol	Chemical composition (%)						
		C	Si	Mn	P	S	Cr	Mo
JIS	SUS440C	0.95~1.20	≤ 1.00	≤ 1.00	≤ 0.040	≤ 0.030	16.00~18.00	≤ 0.75

Remark: Low-chrome steel is also used sometimes.

Table 7.5 Cold Rolled Steel Strip and Cold Rolled Steel Sheet and Plate for Pressed Cage

Standard	Symbol	Chemical composition (%)				
		C	Si	Mn	P	S
BAS	SPB 1	≤ 0.10	≤ 0.04	0.25~0.45	≤ 0.030	≤ 0.030
	SPB 2	0.13~0.20	≤ 0.04	0.25~0.60	≤ 0.030	≤ 0.030
JIS	SPCC	≤ 0.12	—	≤ 0.50	≤ 0.040	≤ 0.045

Table 7.6 High Tensile Strength Brass Casting for Machined Cage

Standard	Symbol	Chemical composition (%)									
		Cu	Zn	Mn	Fe	Al	Sn	Ni	Pb	Si	Others
BAS	HBsCR	55.0~62.0	33.0~37.0	2.0~4.0	0.5~1.5	0.1~1.0	0.1~1.0	≤ 1.0	0.1~1.0	≤ 0.2	≤ 1.0
JIS	CAC301 (HBsC1)	55.0~60.0	33.0~42.0	0.1~1.5	0.5~1.5	0.5~1.5	≤ 1.0	≤ 1.0	≤ 0.4	≤ 0.1	—
	CAC302 (HBsC2)	55.0~60.0	30.0~42.0	0.1~3.5	0.5~2.0	0.5~2.0	≤ 1.0	≤ 1.0	≤ 0.4	≤ 0.1	—

Old symbols are shown in () parentheses

Table 7.7 Steel for Machined Cages

Standard	Symbol	Chemical composition (%)				
		C	Si	Mn	P	S
JIS	S25C	0.22~0.28	0.15~0.35	0.30~0.60	≤ 0.030	≤ 0.035

8. Application of Rolling Contact Bearings

8.1 Fits and Clearance

8.1.1 Importance of Fit

To get the best performance from a rolling contact bearing, the fit between the inner ring and shaft, and outer ring and housing must be correct. If the mating surfaces lack interference, the bearing ring may move circumferentially on the shaft or in the housing. This phenomenon is called creep. Once mating surfaces start to creep, the bearing ring will begin to wear excessively and the shaft and/or housing may be damaged. Abrasive debris may enter the bearing, cause abnormal heating or vibration. Creep is often impossible to prevent by mere fastening of the bearing in an axial direction. To prevent creep, the bearing rings that support the rotating load must be provided with necessary interference. The bearing rings that support stationary load normally do not require interference unless contact corrosion from vibration is a concern.

8.1.2 Selection of Fit

To select the most appropriate fit, the following items must be considered:

- direction of load
- characteristics of load
- magnitude of load
- temperature conditions
- mounting, and dismounting conditions

For general recommendations see Table 8.1. For mounting bearings in a thin-walled housing or on a hollow shaft, larger interference than normal must be provided. Split-housing applications requiring high precision or tight housing bore fits are not recommended. (A split housing may cause the outer ring to deform). For application of bearings subjected to vibration, an interference fit should be applied to both inner and outer rings. Tables 8.2 through 8.14 describe general fit recommendations. For fits not covered by these tables, please contact NACHI.

Table 8.1 Fit vs. Load Characteristics







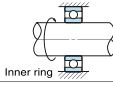

Ring rotation	Type of load	Load conditions	Fit	
			Inner ring	Outer ring
 Inner ring	 Non-rotating	Rotating inner ring load	Interference fit	Loose fit
 Outer ring	 Rotating	Stationary outer ring load	Interference fit	Loose fit
 Outer ring	 Non-rotating	Rotating outer ring load	Loose fit	Interference fit
 Inner ring	 Rotating	Stationary inner ring load	Loose fit	Interference fit
Load direction not constant	Rotating or stationary	Indeterminate direction load	Interference fit	Interference fit

Table 8.2.1 Bearing Bore (°) Fits for Radial Bearings

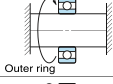
Bearing tolerance class	Tolerance class for shaft O.D.								
	For rotating inner ring load and indeterminate direction load						For rotating outer ring load		
Class 0, class 6	r 6	p 6	n 6	m 5 m 6	k 5 k 6	j 5 j 6 js 6	h 5	h 5 h 6	g 5 g 6
Class 5, class 4	—	—	—	m 5	k 4	js 4	h 4	h 5	—

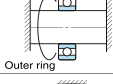
Table 8.2.2 Bearing Outside Diameter (°) Fits for Radial Bearings (Except for Magneto Bearings)

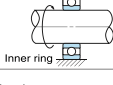
Bearing tolerance class	Tolerance class for housing bore									
	For rotating inner ring load			For indeterminate direction loads			For rotating outer ring load			
Class 0, class 6	—	J 6 J 7	H 6 H 7	G 7	M 7	K 6 K 7	J 6 J 7	P 7	N 7	M 7
Class 5, class 4	K 5	Js 5	H 5	—	—	—	—	—	—	M 5

Table 8.3.1 Bearing Bore or Center Washer Bore (°) Fits for Thrust Bearings

Bearing tolerance class	Tolerance class for shaft O.D.					
	Axial load only		For composite load (spherical roller thrust bearings)			
Class 0	j 6 js 6	n 6	m 6	k 6	j 6 js 6	—

Table 8.3.2 Bearing Outside Diameter (°) Fits for Thrust Bearings

Bearing tolerance class	Tolerance class for housing bore		
	Axial load only		For composite load (spherical roller thrust bearings)
Class 0	—	—	M 7

Note: (°) These dimensional deviations are based on JIS B 1514.

Table 8.4 Shaft Tolerances (°) for Radial Bearings

Operating conditions	Shaft dia. (mm)			Tolerance class for shaft O.D.	Remarks	Examples of application (reference)	
	Ball Bearings	Cylindrical Roller Bearings Tapered Roller Bearings	Spherical Roller Bearings				
●Bearings with cylindrical bore							
Rotating outer ring load	When the inner ring is required to move on the shaft easily. When the inner ring is not required to move on the shaft easily.	For all shaft diameters		g6	When high precision is required, adopt g5 and h5. For large bearings, f6 is also adopted for easy movement.	Wheel on non-rotating shaft Tension pulley, rope sheave	
		For all shaft diameters		h6			
Rotating inner ring load or indeterminate direction load	Light load or fluctuating load	≤ 18	—	—	h5	When high precision is required, adopt j5, k5 and m5 instead of j6, k6 and m6 respectively.	Electrical appliance, Machine tools, pump, blower, hand truck, freight carrier
		18 to 100	≤ 40	—	j6		
		100 to 200	40 to 140	—	k6		
		—	140 to 200	—	m6		
	Normal load or heavy load	≤ 18	—	—	j5	The tolerances of k6 and m6 instead of k5 and m5 can be used for single row tapered roller bearings and single row angular contact ball bearings because the internal clearance fluctuation due to fit need not be considered.	General bearing application, electric motor, turbine, pump, internal combustion engine, wood working machine
		18 to 100	≤ 40	≤ 40	k5		
		100 to 200	40 to 100	40 to 65	m5		
		—	100 to 140	65 to 100	m6		
		—	140 to 200	100 to 140	n6		
		—	200 to 400	140 to 280	p6		
Heavy or shock load	—	—	Over 280	r6	A bearing with an internal clearance larger than CN (normal) clearance is needed.	Axes of locomotive and passenger train, traction motor	
	—	50 to 140	50 to 100	n6			
	—	140 to 200	100 to 140	p6			
Centric axial load	—	—	Over 200	r6	—	—	
	—	≤ 250	—	j6			
—	—	Over 250	—	js6, j6	—	—	
●Bearing with tapered bore (with sleeve)							
For all load conditions	For all shaft diameters	h9/IT5	h10/IT7 can also be used for drive shafts. IT5 and IT7 indicate the shaft form error (roundness, cylindricity) should be limited within the tolerance ranges of IT5 and IT7.	—	General bearing application, railroad car axes		

Note: (°) Shaft tolerances in this table are applied to solid steel shafts.
Remark: Heavy load equals P>0.12Cr, normal load equals 0.12Cr≤P<0.06Cr, light load equals P≤0.06Cr.

Table 8.5 Shaft Tolerances for Thrust Bearings

Operating conditions	Shaft dia. (mm)	Tolerance class for shaft O.D.	
Axial load only (Thrust ball bearings and spherical roller thrust bearings)	≤ 250	j6	
	Over 250	js6, j6	
Composite load (Spherical Roller Thrust Bearings)	Rotating outer ring load	≤ 250	j6
		Over 250	js6, j6
	Rotating inner ring load or indeterminate direction load	≤ 200	k6
		200 to 400	m6
Over 400	n5		

Table 8.6 Housing Tolerances (*) for Radial Bearings (Except Inch-Series Tapered Roller Bearings)

Operating conditions		Tolerance class for housing bore	Outer ring movement (*)	Examples of application (reference)	
Monoblock housing	Rotating outer ring load	When a heavy load is applied to a thin-walled housing or impact load	P7	Outer ring cannot move	Automotive wheel (roller bearing)
		Normal load or heavy load	N7		Automotive wheel (ball bearing)
		Light load or fluctuating load	M7		Conveyor roller, pulley, tension pulley
Indeterminate direction load		Heavy impact load	K7	Outer ring cannot move as principle	Traction motor
		Heavy load or normal load: When the outer ring is not required to move in an axial direction			
Monoblock or split housing	Rotating inner ring load	Normal load or light load: When it is desirable that the outer ring can be moved in an axial direction	J7	Outer ring can move	Electric motor, pump, crank shaft main bearing
		Impact load: When no-load condition occurs temporarily			Railroad car axle
		All kinds of loads	H7	Outer ring can move easily	General bearing application, railroad car axle bearing
		Normal load or light load	H8		Gear transmission
		When there is thermal conduction through the shaft	G7		Paper mill (drying cylinder)
Monoblock housing	When extremely high accuracy is required	Fluctuating load: When extremely accurate rotation and high rigidity are required	N6	Outer ring cannot move	Roller bearing (outside diameter is over 125 mm) for spindle of machine tool
			M6		Roller bearing (outside diameter is under and including 125 mm) for spindle of machine tool
		Indeterminate direction light load: When extremely accurate rotation is required.	K6	Outer ring cannot move as principle	Spindle of grinding machine, ball bearing on grinding wheel side. High speed centrifugal compressor, fixed side bearing
		When extremely accurate rotation is required: When it is desirable that outer ring can be moved in axial direction.	J6	Outer ring can move	Spindle of grinding machine, ball bearing on drive side. High speed centrifugal compressor, free side bearing.

Notes: (*) This table applies to cast iron or steel housings. For light alloy housings, a tighter fit is used rather than those that meet with the tolerances in this table.
 (†) Indicates whether the outer ring can or cannot move in axial direction for non-separable bearings.

Table 8.7 Housing Tolerances for Thrust Bearings

Operating conditions		Tolerance class for housing bore	Remarks
Axial load only (All thrust bearings)	Thrust Ball Bearings	H8	When high accuracy is not required, outer ring or aligning seat is mounted to provide clearance in radial direction.
	Spherical roller thrust bearings: When radial load is borne by another bearing.	—	Outer ring radial clearance is approximately 0.001D.
Composite load (Spherical Roller Thrust Bearings)	Stationary outer ring load or indeterminate direction load	H7 J7	—
	Rotating outer ring load	K7 M7	Bearing application in general When the radial load is comparatively large

Table 8.8 Fits of Inch Series Tapered Roller Bearings with Shafts

Table 8.8.1 For Bearings with ABMA Class 4

Unit: μm

Operating conditions			Nominal bearing bore diameter d (mm)		Bearing bore deviation		Shaft diameter deviation		Fit value (1)		
			Over	Incl.	High	Low	High	Low	Max	Min	
Rotating inner ring load	Normal load No impact	—	76.2	+13	0	+38	+26	38T	12T		
		76.2	304.8	+25	0	+64	+38	64T	13T		
		304.8	609.6	+51	0	+127	+76	127T	25T		
	609.6	914.4	+76	0	+191	+114	191T	38T			
	Heavy load High speed rotation Impact load	—	76.2	+13	0	+64	+38	64T	25T		
		76.2	304.8	+25	0			(*)			
304.8		609.6	+51	0							
609.6	914.4	+76	0	+381	+305	381T	229T				
Rotating outer ring load	Normal load no impact	—	76.2	+13	0	+13	0	13T	13L		
		76.2	304.8	+25	0	+25	0	25T	25L		
		304.8	609.6	+51	0	+51	0	51T	51L		
	609.6	914.4	+76	0	+76	0	76T	76L			
	Normal load no impact	For non-grinding shaft (when ring is not needed to move on shaft)	—	76.2	+13	0	+13	0	13T	13L	
		76.2	304.8	+25	0	+25	0	25T	25L		
304.8		609.6	+51	0	+51	0	51T	51L			
609.6	914.4	+76	0	+76	0	76T	76L				
Normal load no impact	Grinding machine shaft (when ring is needed to move on shaft)	—	76.2	+13	0	0	-13	0	26L		
	76.2	304.8	+25	0	0	-25	0	51L			
	304.8	609.6	+51	0	0	-51	0	102L			
609.6	914.4	+76	0	0	-76	0	152L				

Notes: (1) T: Tight fit, L: Loose fit.
(*) Mean amounts of tight fits are d/2000 mm.

Table 8.8.2 For Bearings with ABMA Class 3 and Class 0

Unit: μm

Operating conditions			Nominal bearing bore diameter d (mm)		Bearing bore deviation		Shaft diameter deviation		Fit value (1)	
			Over	Incl.	High	Low	High	Low	Max	Min
Rotating inner ring load	Main shaft of precision machine tool	—	304.8	+13	0	+38	+18	31T	5T	
		304.8	609.6	+25	0	+64	+38	64T	13T	
		609.6	914.4	+38	0	+102	+63	102T	25T	
	Heavy load High speed rotation Impact load	—	76.2	+13	0			(*)		
		76.2	304.8	+13	0					
		304.8	609.6	+25	0					
609.6	914.4	+38	0							
Rotating outer ring load	Main shaft of precision machine tool	—	304.8	+13	0	+13	+18	31T	5T	
		304.8	609.6	+25	0	+64	+38	64T	13T	
		609.6	914.4	+38	0	+102	+63	102T	25T	

Notes: (1) T: Tight fit, L: Loose fit.
(*) Mean amounts of tight fits are d/4000 mm.
(*) Bearing bore d of less than 241.3 mm are applied for class 0.

Table 8.9 Fits of Inch Series Tapered Roller Bearings with Housings

Table 8.9.1 For Bearings with ABMA Class 4

Unit: μm

Operating conditions			Nominal bearing outside diameter D (mm)		Bearing outside diameter deviation		Housing bore diameter deviation		Fit value (1)	
			Over	Incl.	High	Low	High	Low	Max	Min
Rotating inner ring load	Floating side or clamping side	—	76.2	+25	0	+76	+50	25L	76L	
		76.2	127.0	+25	0	+76	+50	25L	76L	
		127.0	304.8	+25	0	+76	+50	25L	76L	
		304.8	609.6	+51	0	+152	+102	51L	152L	
		609.6	914.4	+76	0	+229	+152	76L	229L	
		—	76.2	+25	0	+25	0	25T	25L	
	Outer ring location in axial direction can be adjusted	76.2	127.0	+25	0	+25	0	25T	25L	
		127.0	304.8	+25	0	+51	0	25T	51L	
		304.8	609.6	+51	0	+76	+26	25T	76L	
		609.6	914.4	+76	0	+127	+51	25T	127L	
		—	76.2	+25	0	-13	-39	64T	13T	
		76.2	127.0	+25	0	-25	-51	76T	25T	
Outer ring location in axial direction cannot be adjusted	127.0	304.8	+25	0	-25	-51	76T	25T		
	304.8	609.6	+51	0	-25	-76	127T	25T		
	609.6	914.4	+76	0	-25	-102	178T	25T		
	—	76.2	+25	0	-13	-39	64T	13T		
	76.2	127.0	+25	0	-25	-51	76T	25T		
	127.0	304.8	+25	0	-25	-51	76T	25T		
Rotating outer ring load	Outer ring location in axial direction cannot be adjusted	304.8	609.6	+51	0	-25	-76	127T	25T	
		609.6	914.4	+76	0	-25	-102	178T	25T	
		—	76.2	+25	0	-13	-39	64T	13T	
		76.2	127.0	+25	0	-25	-51	76T	25T	
		127.0	304.8	+25	0	-25	-51	76T	25T	
		304.8	609.6	+51	0	-25	-76	127T	25T	
609.6	914.4	+76	0	-25	-102	178T	25T			

Notes: (1) L: Loose fit, T: Tight fit.

Table 8.9.2 For Bearings with ABMA Class 3 and Class 0

Unit: μm

Operating conditions			Nominal bearing outside diameter D (mm)		Bearing outside diameter deviation		Housing bore diameter deviation		Fit value (1)	
			Over	Incl.	High	Low	High	Low	Max	Min
Rotating inner ring load	Floating side	—	152.4	+13	0	+38	+26	13L	38L	
		152.4	304.8	+13	0	+38	+26	13L	38L	
		304.8	609.6	+25	0	+64	+38	13L	64L	
	609.6	914.4	+38	0	+99	+51	13L	89L		
	Clamping side	—	152.4	+13	0	+25	+13	0	25L	
		152.4	304.8	+13	0	+25	+13	0	25L	
		304.8	609.6	+25	0	+51	+25	0	51L	
	609.6	914.4	+38	0	+76	+38	0	76L		
	Outer ring location in axial direction can be adjusted	—	152.4	+13	0	+13	0	13T	13L	
		152.4	304.8	+13	0	+25	0	13T	25L	
		304.8	609.6	+25	0	+25	0	25T	25L	
	609.6	914.4	+38	0	+38	0	38T	38L		
Outer ring location in axial direction cannot be adjusted	—	152.4	+13	0	0	-12	25T	0		
	152.4	304.8	+13	0	0	-25	38T	0		
	304.8	609.6	+25	0	0	-26	51T	0		
609.6	914.4	+38	0	0	-38	76T	0			
Rotating outer ring load	Normal load Outer ring location in axial direction cannot be adjusted	—	152.4	+13	0	-13	-25	38T	13T	
		152.4	304.8	+13	0	-13	-38	51T	13T	
		304.8	609.6	+25	0	-13	-39	64T	13T	
609.6	914.4	+38	0	-13	-51	89T	13T			

Notes: (1) L: Loose fit, T: Tight fit.
(*) Bearing outer diameter D of less than 304.8 mm are applied for class 0.

Table 8.10 Amounts of Fits: Radial Bearings with Tolerance JIS Class 0 (ISO Normal Class)

Table 8.10.1 Inner Ring with Shaft

Unit: μm

Nominal dimensions (mm)		Deviation of single plane mean bore dia. of bearing (') High Low		Shaft with tolerance grade IT5										Shaft with tolerance grade IT6															
				m5		h5		j5		h5		g5		r6		p6		n6		m6		k6		j6		h6		g6	
				Tight	Loose	Tight	Loose	Tight	Loose	Tight	Loose	Tight	Loose	Tight	Loose	Tight	Loose	Tight	Loose	Tight	Loose	Tight	Loose	Tight	Loose	Tight	Loose	Tight	Loose
Over	Incl.																												
3	6	0	-8																										
6	10	0	-8																										
10	18	0	-8																										
18	30	0	-10																										
30	50	0	-12																										
50	80	0	-15																										
80	120	0	-20																										
120	140																												
140	160	0	-25																										
160	180																												
180	200																												
200	225	0	-30																										
225	250																												
250	280	0	-35																										
280	315																												
315	355	0	-40																										
355	400																												
400	450	0	-45																										
450	500																												

Note: (') Δ dmp specified in JIS B 1514.

Table 8.10.2 Outer Ring with Housing

Unit: μm

Nominal dimensions (mm)		Deviation of single plane mean outer dia. of bearing (') High Low		Housing with tolerance grade IT6						Housing with tolerance grade IT7																		
				K6		J6		H6		P7		N7		M7		K7		J7		H7		G7						
				Tight	Loose	Tight	Loose	Tight	Loose	Tight	Loose	Tight	Loose	Tight	Loose	Tight	Loose	Tight	Loose	Tight	Loose	Tight	Loose	Min	Max			
Over	Incl.																											
6	10	0	-8																									
10	18	0	-8																									
18	30	0	-8																									
30	50	0	-11																									
50	80	0	-13																									
80	120	0	-15																									
120	150	0	-18																									
150	180	0	-25																									
180	250	0	-30																									
250	315	0	-35																									
315	400	0	-40																									
400	500	0	-45																									

Note: (') Δ Dmp specified in JIS B 1514.

Table 8.11 Amounts of Fits: Radial Bearings with Tolerance JIS (ISO) Class 6

Table 8.11.1 Inner Ring with Shaft

Unit: μm

Nominal dimensions (mm)		Deviation of single plane mean bore dia. of bearing (') High Low		Shaft with tolerance grade IT5										Shaft with tolerance grade IT6															
				m5		h5		j5		h5		g5		r6		p6		n6		m6		k6		j6		h6		g6	
				Tight	Loose	Tight	Loose	Tight	Loose	Tight	Loose	Tight	Loose	Tight	Loose	Tight	Loose	Tight	Loose	Tight	Loose	Tight	Loose	Tight	Loose	Tight	Loose	Tight	Loose
Over	Incl.	High	Low	Max	Min	Max	Min	Max	Min	Max	Min	Max	Min	Max	Min	Max	Min	Max	Min	Max	Min	Max	Min	Max	Min	Max	Min	Max	
3	6	0	-7	-	-	-	-	10	2	7	5	3	9	-	-	-	-	-	-	-	-	13	2	7	8	3	12		
6	10	0	-7	-	-	-	-	11	2	7	6	2	11	-	-	-	-	-	-	-	-	14	2	7	9	2	14		
10	18	0	-7	-	-	16	1	12	3	7	8	1	14	-	-	-	-	-	-	19	1	15	3	7	11	1	17		
18	30	0	-8	-	-	19	2	13	4	8	9	1	16	-	-	-	-	-	23	2	17	4	8	13	1	20			
30	50	0	-10	30	9	23	2	16	5	10	11	1	20	-	-	-	43	17	35	9	28	2	21	5	10	16	1	25	
50	80	0	-12	36	11	27	2	18	7	12	13	2	23	-	-	-	51	20	42	11	33	2	24	7	12	19	2	29	
80	120	0	-15	43	13	33	3	21	9	15	15	3	27	-	-	74	37	60	23	50	13	40	3	28	9	15	22	3	34
120	140													106	63														
140	160	0	-18	51	15	39	3	-	-	18	18	4	32	108	65	86	43	70	27	58	15	46	3	32	11	18	25	4	39
160	180													111	68														
180	200													128	77														
200	225	0	-22	58	17	46	4	-	-	22	20	7	35	131	80	101	50	82	31	68	17	55	4	38	13	22	29	7	44
225	250													138	84														

Note: (') Δdmp specified in JIS B 1514.

Table 8.11.2 Outer Ring with Housing

Unit: μm

Nominal dimensions (mm)		Deviation of single plane mean outer dia. of bearing (') High Low		Housing with tolerance grade IT6						Housing with tolerance grade IT7																
				K6		J6		H6		P7		N7		M7		K7		J7		H7		G7				
				Tight	Loose	Tight	Loose	Tight	Loose	Tight	Loose	Tight	Loose	Tight	Loose	Tight	Loose	Tight	Loose	Tight	Loose	Tight	Loose	Tight	Loose	
Over	Incl.	High	Low	Max	Min	Max	Min	Max	Min	Max	Min	Max	Min	Max	Min	Max	Min	Max	Min	Max	Min	Max	Min	Max	Min	Max
6	10	0	-7	7	9	4	12	0	16	24	2	19	3	15	7	10	12	7	15	0	22	5	27			
10	18	0	-7	9	9	5	13	0	18	29	4	23	2	18	7	12	13	8	17	0	25	6	31			
18	30	0	-8	11	10	5	16	0	21	35	6	28	1	21	8	15	14	9	20	0	29	7	36			
30	50	0	-9	13	12	6	19	0	25	42	8	33	1	25	9	18	16	11	23	0	34	9	43			
50	80	0	-11	15	15	6	24	0	30	51	10	39	2	30	11	21	20	12	29	0	41	10	51			
80	120	0	-13	18	17	6	29	0	35	59	11	45	3	35	13	25	23	13	35	0	48	12	60			
120	150	0	-15	21	19	7	33	0	40	68	13	52	3	40	15	28	27	14	41	0	55	14	69			
150	180	0	-18	21	22	7	36	0	43	68	10	60	6	40	18	28	30	14	44	0	58	14	72			
180	250	0	-20	24	25	7	42	0	49	79	13	60	6	46	20	33	33	16	50	0	66	15	81			
250	315	0	-25	27	30	7	50	0	57	88	11	66	11	52	25	36	41	16	61	0	77	17	94			
315	400	0	-280	29	35	7	57	0	64	98	13	73	12	57	28	40	45	18	67	0	85	18	103			

Note: (') Δdmp specified in JIS B 1514.

Table 8.12 Amounts of Fits: Radial Bearings with Tolerance JIS (ISO) Class 5

Table 8.12.1 Inner Ring with Shaft Unit: μm

Nominal dimensions (mm)		Deviation of single plane mean bore dia. of bearing (')		Shaft with tolerance grade IT4								Shaft with tolerance grade IT5			
				m4		k4		js4		h4		m5		h5	
				Tight	Loose	Tight	Loose	Tight	Loose	Tight	Loose	Tight	Loose	Tight	Loose
Over	Incl.	High	Low	Max	Min	Max	Min	Max	Min	Max	Min	Max	Min	Max	
3	6	0	-5	13	4	10	1	7	2	5	4	14	4	5	5
6	10	0	-5	15	6	10	1	7	2	5	4	17	6	5	6
10	18	0	-5	17	7	11	1	7.5	2.5	5	5	20	7	5	8
18	30	0	-6	20	8	14	2	9	3	6	6	23	8	6	9
30	50	0	-8	24	9	17	2	11.5	3.5	8	7	28	9	8	11
50	80	0	-9	28	11	19	2	13	4	9	8	33	11	9	13
80	120	0	-10	33	13	23	3	15	5	10	10	38	13	10	15
120	180	0	-13	40	15	28	3	19	6	13	12	46	15	13	18
180	250	0	-15	46	17	33	4	22	7	15	14	52	17	15	20

Note: (') Δ dmp specified in JIS B 1514.

Table 8.13 Amounts of Fits: Radial Bearings with Tolerance JIS (ISO) Class 4

Table 8.13.1 Inner Ring with Shaft Unit: μm

Nominal dimensions (mm)		Deviation of single plane mean bore dia. of bearing (')		Shaft with tolerance grade IT4								Shaft with tolerance grade IT5			
				m4		k4		js4		h4		m5		h5	
				Tight	Loose	Tight	Loose	Tight	Loose	Tight	Loose	Tight	Loose	Tight	Loose
Over	Incl.	High	Low	Max	Min	Max	Min	Max	Min	Max	Min	Max	Min	Max	
3	6	0	-4	12	4	9	1	6	2	4	4	13	4	4	5
6	10	0	-4	14	6	9	1	6	2	4	4	16	6	4	6
10	18	0	-4	16	7	10	1	6.5	2.5	4	5	19	7	4	8
18	30	0	-5	19	8	13	2	8	3	5	6	22	8	5	9
30	50	0	-6	22	9	15	2	9.5	3.5	6	7	26	9	6	11
50	80	0	-7	26	11	17	2	11	4	7	8	31	11	7	13
80	120	0	-8	31	13	21	3	13	5	8	10	36	13	8	15
120	180	0	-10	37	15	25	3	16	6	10	12	43	15	10	18
180	250	0	-12	43	17	30	4	19	7	12	14	49	17	12	20

Note: (') Δ dmp specified in JIS B 1514.

Table 8.12.2 Outer Ring with Housing Unit: μm

Nominal dimensions (mm)		Deviation of single plane mean outer dia. of bearing (')		Housing with tolerance grade IT5								
				M5		K5		Js5		H5		
				Tight	Loose	Tight	Loose	Tight	Loose	Tight	Loose	
Over	Incl.	High	Low	Max	Min	Max	Min	Max	Min	Max	Min	Max
6	10	0	-5	10	1	5	6	3	8	0	11	
10	18	0	-5	12	1	6	7	4	9	0	13	
18	30	0	-6	14	1	8	7	4.5	10.5	0	15	
30	50	0	-7	16	2	9	9	5.5	12.5	0	18	
50	80	0	-9	19	3	10	12	6.5	15.5	0	22	
80	120	0	-10	23	2	13	12	7.5	17.5	0	25	
120	150	0	-11	27	2	15	14	9	20	0	29	
150	180	0	-13	27	4	15	16	9	22	0	31	
180	250	0	-15	31	4	18	17	10	25	0	35	
250	315	0	-18	36	5	20	21	11.5	29.5	0	41	
315	400	0	-20	39	6	22	23	12.5	32.5	0	45	

Note: (') Δ Dmp specified in JIS B 1514.

Table 8.13.2 Outer Ring with Housing Unit: μm

Nominal dimensions (mm)		Deviation of single plane mean outer dia. of bearing (')		Housing with tolerance grade IT5								
				M5		K5		Js5		H5		
				Tight	Loose	Tight	Loose	Tight	Loose	Tight	Loose	
Over	Incl.	High	Low	Max	Min	Max	Min	Max	Min	Max	Min	Max
6	10	0	-4	10	0	5	5	3	7	0	10	
10	18	0	-4	12	0	6	6	4	8	0	12	
18	30	0	-5	14	0	8	6	4.5	9.5	0	14	
30	50	0	-6	16	1	9	8	5.5	11.5	0	17	
50	80	0	-7	19	1	10	10	6.5	13.5	0	20	
80	120	0	-8	23	0	13	10	7.5	15.5	0	23	
120	150	0	-9	27	0	15	12	9	18	0	27	
150	180	0	-10	27	1	15	13	9	19	0	28	
180	250	0	-11	31	0	18	13	10	21	0	31	
250	315	0	-13	36	0	20	16	11.5	24.5	0	36	
315	400	0	-15	39	1	22	18	12.5	27.5	0	40	

Note: (') Δ Dmp specified in JIS B 1514.

Table 8.14 Amounts of Fits: Thrust Bearings with Tolerance JIS (ISO) Class 0

Table 8.14.1 Shaft Washer or Center Washer with Shaft Unit: μm

Nominal dimensions (mm)		Deviation of single plane mean bore dia. of bearing (') High Low		Shaft with tolerance grade IT6							
				n6		m6		k6		j6	
				Tight	Loose	Tight	Loose	Tight	Loose	Tight	Loose
Over	Incl.	Max	Min	Max	Min	Max	Min	Max	Min	Max	Min
6	10	0	-8	—	—	—	—	18	1	15	2
10	18	0	-8	—	—	—	—	20	1	16	3
18	30	0	-10	—	—	—	—	25	2	19	4
30	50	0	-12	—	—	—	—	30	2	23	5
50	80	0	-15	—	—	—	—	36	2	27	7
80	120	0	-20	—	—	—	—	45	3	33	9
120	180	0	-25	—	—	—	—	53	3	39	11
180	250	0	-30	—	—	76	17	63	4	46	13
250	315	0	-35	—	—	87	20	—	—	51	16
315	400	0	-40	—	—	97	21	—	—	58	18
400	500	0	-45	125	40	—	—	—	—	65	20

Note: (') ΔDmp specified in JIS B 1514.

Table 8.14.2 Housing with Housing Unit: μm

Nominal dimensions (mm)		Deviation of single plane mean outer dia. of bearing (') High Low		Housing with tolerance grade IT7			
				M7		H7	
				Tight	Loose	Tight	Loose
Over	Incl.	Max	Max	Max	Max	Max	Max
10	18	0	-11	18	11	0	29
18	30	0	-13	21	13	0	34
30	50	0	-16	25	16	0	41
50	80	0	-19	30	19	0	49
80	120	0	-22	35	22	0	57
120	180	0	-25	40	25	0	65
180	250	0	-30	46	30	0	76
250	315	0	-35	52	35	0	87
315	400	0	-40	57	40	0	97
400	500	0	-45	63	45	0	108

Note: (') ΔDmp specified in JIS B 1514.

8.1.3 Calculating Fits

The fits for bearings are often determined empirically according to Table 8.1 through Table 8.14. These tables are NOT to be used for the following cases:

- If special materials are used for interfaces.
- If a hollow shaft is used.
- For high-precision applications.

(1) Reduction of Interference due to Bearing Load

When load is applied through a rotating inner ring, the ring will deform slightly and a gap will occur between the ring and the shaft at a position 180° from the point of load. This gap and "arc-of-no-contact" will increase as the

load becomes heavier. A gearing effect will also occur due to the difference in diameters of rotation of the interfacing parts.

Formula (8.1) and Fig. 8.1 define the reduction (millimeters) in interference fit of the inner ring due to bearing load.

$$\Delta dF = 0.08 \times 10^{-3} \sqrt{\frac{d}{B}} Fr \quad \text{..... (8.1)}$$

where:

- ΔdF : Reduction in interference of inner ring fit due to bearing load (mm)
- d : Bearing bore (shaft diameter) (mm)
- B : Bearing inner ring width (mm)
- Fr : Radial load on the bearing (N)

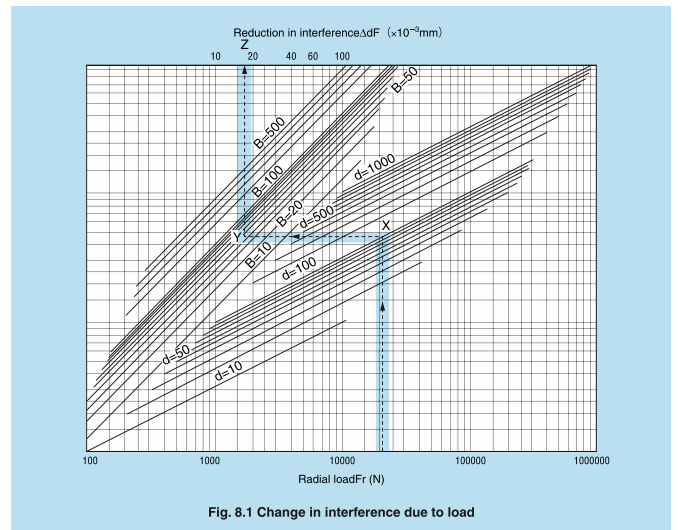

Fig. 8.1 Change in interference due to load

If the radial load is greater than 20% of the basic static load rating C_{or} , Formula (8.2) is to be used.

$$\Delta dF \geq 0.02 \times 10^{-3} \frac{F_r}{B} \dots\dots\dots (8.2)$$

Calculation example: 6
 Object: to obtain the amount of reduction in interference from bearing load where F_r on a single-row, Deep-groove ball bearing number 6320 is 21000N.
 From the dimensional tables, $d=100$ mm, $B=47$ mm. From Fig. 8.1;
 (a) Find 21000 on the line of F_r . Move vertically and intersect the line of $d=100$ (at point X).
 (b) From the point X, move parallel with line F_r and intersect the line of $B=47$ (at point Y).

(c) Extend vertically from point Y. The intercept with the chart upper limit at point Z indicates the reduction dF (mm) of interference. In this case, ΔdF loss=0.017 (mm).

(2) Reduction in Interference due to temperature difference
 Operating temperature differences will generally exist between the inner ring and shaft or the outer ring and bearing housing. Fits must be adjusted for differences of thermal expansion coefficients in the mating materials.
 • If the bearing temperature is higher than that of the shaft, increase the fit.
 • If heat is transferred through the shaft, the fit becomes tighter due to thermal expansion of the shaft. In such cases, increase the radial internal clearance of the bearing.

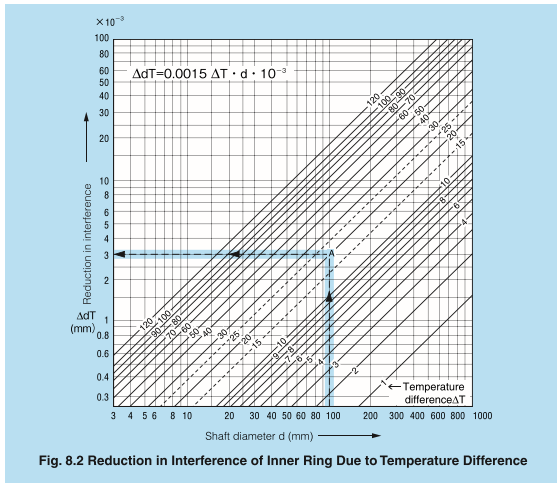

Fig. 8.2 Reduction in Interference of Inner Ring Due to Temperature Difference

- When the outer ring temperature is higher than the housing, reduce the fit with the housing and the radial internal clearance of the bearing.
- If the housing temperature is hotter than the bearing outer ring, check the rates of thermal expansion. It will probably be necessary to increase the fit due to larger growth of the housing bore.

Reduction of interference fit of the inner ring due to temperature differentials can be calculated using Formula (8.3) and Fig. 8.2.

$$\Delta dT = 0.0015 \Delta T \cdot d \cdot 10^{-3} \dots\dots\dots (8.3)$$

- where:
- ΔdT : Reduction in interference of inner ring fit due to temperature difference (mm)
 - ΔT : Temperature difference between bearing and housing ambient (°C)
 - d : Bearing bore (shaft diameter) (mm)

Calculation example: 7
 Obtain the reduction in interference for a temperature difference of 20°C existing between housing ambient temperature and internal temperature of a bearing with a bore diameter of 100 mm. From Fig. 8.2.

- Find the bore diameter $d=100$ on the horizontal axis. Draw a vertical line from the point until it intersects the line of temperature difference of 20°C at point A.
- Extend a line horizontally from point A left to the Y-axis. The reduction in interference can be read from the intersection with the vertical axis as $\Delta dT=0.003$ mm.

(3) Surface Finish Effects on Interference
 Since surface asperities are subjected to smoothing when bearings are press-fit, the effective fit becomes smaller than the calculated fit. The amount of reduction in fit is dependent on the surface finish of the interfacing materials.

Effective fit of the inner ring to a solid shaft is calculated using Formulas (8.4.1), and (8.4.2). For ground and polished shafts,

$$\Delta d_e = \frac{d}{d+2} \Delta d_a \dots\dots\dots (8.4.1)$$

For turned shafts,

$$\Delta d_e = \frac{d}{d+3} \Delta d_a \dots\dots\dots (8.4.2)$$

- where:
- Δd_e : Effective interference (mm)
 - Δd_a : Calculated interference (mm)
 - d : Bearing bore diameter (mm)

(4) Necessary Interference for Inner Rings
 Formulas (8.1), (8.2), (8.3), (8.4.1) and (8.4.2) have been used to calculate the effects of Load, Temperature, and Surface Finish in interference. To summarize the effects to a total required interference for the inner ring and shaft (where inner ring rotates against load), refer to Formulas (8.5.1) and (8.5.2).

For ground and polished shafts,

$$\Delta d_a \geq (\Delta dF + \Delta dT) \left(\frac{d+2}{d} \right) \dots\dots\dots (8.5.1)$$

For turned shafts,

$$\Delta d_a \geq (\Delta dF + \Delta dT) \left(\frac{d+3}{d} \right) \dots\dots\dots (8.5.2)$$

(5) Tensile Stress from Fits
 When interference is provided, the bearing ring undergoes tensile stress. If the stress is excessive, the bearing ring will be damaged. When an inner ring is fitted to a solid steel shaft, stress, σ_i , should be limited to 100MPa or smaller using Formula (8.6). Empirically, the criterion of interference 0.001 of shaft diameter.

$$\sigma_i = \frac{E}{2} \cdot \frac{\Delta d_e}{d} \left\{ 1 + \left(\frac{d}{d_i} \right)^2 \right\} \dots\dots\dots (8.6)$$

where:
 σ_i : Maximum tensile stress of inner ring (MPa)
 E : Young's modulus for steel: 2.07×10^5 (MPa)
 Δd_e : Effective interference (mm)
 d : Bearing bore diameter (mm)
 d_i : Mean outside diameter of inner ring (mm)
 Cylindrical roller bearings; and Self-aligning ball bearings of series 22 and 23:
 $d_i \approx 0.25(D+3d)$

All other bearings:
 $d_i \approx 0.1(3D+7d)$

where:
 D: Bearing outside diameter (mm)

(6) Fits for Inner Rings with Hollow Shaft
 Equivalent effective fit for a hollow shaft.

- (a) Obtain the interference, Δd_a for a solid shaft of the identical diameter inner ring with either Table 8.4 or Formulas (8.5.1) and (8.5.2).
- (b) Calculate interference Δd_{ha} for a hollow shaft and inner ring with Formula (8.7).

$$\Delta d_{ha} = \frac{1 - \left(\frac{d_h}{d_i} \right)^2}{1 - \left(\frac{d_h}{d} \right)^2} \Delta d_a \dots\dots\dots (8.7)$$

where:
 Δd_{ha} : Calculated interference of hollow shaft (mm)
 d_h : Bore diameter of hollow shaft (mm). For solid shaft, $d_h = 0$
 d : bearing bore diameter (mm)
 Δd_a : Calculated interference of solid shaft and inner ring (mm)

(c) Tensile stress of inner ring from fits for hollow steel shaft is calculated using Formula (8.8).

$$\sigma_i = \frac{E}{2} \cdot \frac{\Delta d_e}{d} \cdot \frac{\left\{ 1 - \left(\frac{d_h}{d} \right)^2 \right\} \left\{ 1 + \left(\frac{d}{d_i} \right)^2 \right\}}{\left\{ 1 - \left(\frac{d_h}{d_i} \right)^2 \right\}} \dots\dots (8.8)$$

(7) Outer Ring to Housing Fits
 Interference fit must be provided between the outer ring and housing where there is rotating outer ring load or indeterminate load. Fits for outer ring and steel housing can be obtained by using Table 8.6

8.1.4 Selection of Bearing Clearance

The internal clearance of rolling contact bearings during operation (the operating clearance) is a factor which can affect bearing life, vibration, heat, sound, etc.

Theoretically, bearing life is maximum if bearings operate with a slight preload (a slight negative operating clearance). If a bearing is to operate with a slight preload, great care must be taken in the analysis and design of the application to be sure that preloads do not begin to rise during the bearing operation to a level which will lead to an upward spiraling of heat=greater preload=more heat=early bearing failure. And also a bearing with an excessive operating clearance will not perform its maximum load capability.

To prevent clearance problems, unmounted bearing clearance should be selected so that operating clearance will be slightly positive. (Note that bearings chosen for precision location functions are preloaded, but the amount of preload must be precisely controlled at assembly).

For non-separable, radial bearings, and for radial Cylindrical roller bearings, which are

assembled in clearance groups with a set amount of "unmounted" internal clearance; the initial internal clearance will be the unmounted clearance minus clearance losses from mounting fits.

Typical clearance groups for the above types of bearings are:

- C2: less than Normal clearance
- CN: Normal clearance
- C3: more than Normal clearance

CN (Normal) internal clearance is determined so that appropriate clearance will remain after the bearing is mounted to the shaft with an interference fit, but with no fit (no interference) between the outer ring and housing and the temperature difference between inner and outer ring is 10°C or less.

Table 8.15 indicates examples of selection for clearance groups other than CN (Normal) internal clearance.

Bearing clearance varies during operation with respect to the temperature rise and the type and magnitude of load. For example, if large reduction of clearance is expected, more initial clearance is required.

Table 8.15 Examples of Clearance Selection other than CN (Normal) Clearance

Application conditions	Clearance Selection	Examples of application (reference)
Large interference for heavy or impact load		Railroad car axle
Interference required for both inner and outer rings due to indeterminate heavy impact load		Traction motor
Inner ring is exposed to high temperature Outer ring is exposed to low temperature	C3 clearance or larger	Pulp and paper machine dryer For outdoor use in cold area
When shaft has a large deflection For increasing axial load capacity by increasing contact angle.		Semi-floating axle for automobiles Bearing of rail road car axle for carrying axial load
When both inner and outer rings are clearance fitted	C2 clearance or smaller	Roll neck of rolling machine
For controlling vibration and sound		Small, special electric motors
For post assembly adjustment of clearance such as controlling run-out of shaft, etc.	C9na, C1na	Cylindrical roller bearing for lathe main shaft

Fig. 8.3 illustrates radial clearance of a single-row Deep-groove ball bearing.

(1) Operating Clearance

Operating clearance is defined as the clearance of a bearing operating in a machine at the operating temperature and load.

$$\Delta = \Delta o - (\delta t + \delta f) + \delta w \quad \text{..... (8.10)}$$

where:

- Δ : Operating clearance (mm)
- Δo : unmounted bearing clearance
- δt : Variation of clearance from temperature difference between inner and outer rings (mm)
- δf : Reduction in clearance due to the fit of inner and outer rings (mm)
- δw : Increase of clearance due to load (mm)

(2) Internal clearance reduction due to temperature difference between inner and outer rings

Under normal operating conditions, the temperature of the rolling contact bearing components is, in ascending order from the lowest to the highest; the outer ring, the inner ring, and the rolling elements. Since it is extremely difficult to measure the temperature of the rolling elements, operating temperature is calculated under the assumption that the temperature of the rolling element is equal to that of the inner ring. Therefore, the reduction in clearance due to temperature difference between the inner and outer rings can be obtained by the following formula:

$$\delta t = \alpha \cdot \Delta T \cdot D_o \quad \text{..... (8.11)}$$

where:

- δt : Reduction in clearance due to temperature difference between inner and outer rings (mm)
- α : Linear expansion coefficient of bearing steel: 1.12×10^{-5} (1/°C) for operating temperature 300°C or less
- ΔT : Temperature difference between the inner and outer rings (°C)
- D_o : Outer ring raceway diameter (mm)
 $D_o \approx 0.2(4D+d)$ for Deep-groove ball bearings and Spherical roller bearings.
 $D_o \approx 0.25(3D+d)$ for Cylindrical roller bearings.

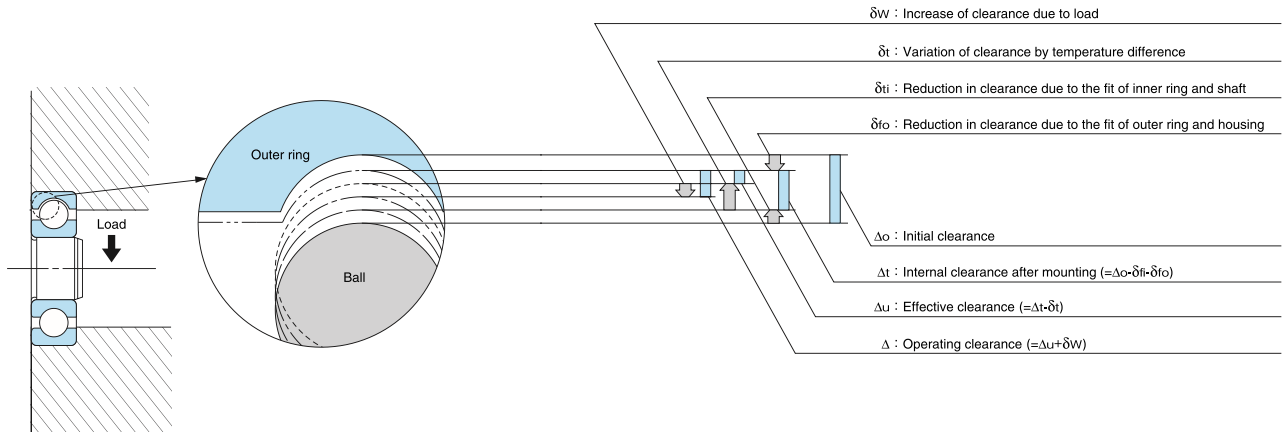

Fig. 8.3 Radial clearance of bearing

(3) Reduction in clearance due to fit

When a bearing is mounted to a shaft or housing with an interference fit, the inner ring will expand or the outer ring will contract (due to the fit), causing reduction in the bearing internal clearance. Reduction in clearance due to fit can be calculated from the following formula:

$$\delta f = \delta fi + \delta fo \quad (8.12)$$

where:

- δf : Reduction in clearance due to fit (mm)
- δfi : Reduction in clearance due to expansion of the inner ring (mm)
- δfo : Reduction in clearance due to the contraction of the outer ring (mm)

$$\delta fi = \Delta de \cdot \frac{d}{di} \cdot \frac{1 - \left(\frac{dh}{d}\right)^2}{1 - \left(\frac{dh}{di}\right)^2} \quad (8.13)$$

$$\delta fo = \Delta De \cdot \frac{De}{D} \cdot \frac{1 - \left(\frac{Dh}{D}\right)^2}{1 - \left(\frac{Dh}{De}\right)^2} \quad (8.14)$$

where:

- Δde : Effective interference of the inner ring (mm)
- d : Bearing bore diameter (mm)
- di : Mean outside diameter of inner ring (mm)
- dh : Inside diameter of hollow shaft (mm)
(Note): For solid shaft, $dh=0$
- ΔDe : Effective interference of outer ring (mm)
- D : Bearing outside diameter (mm)
- De : Mean inside diameter of outer ring (mm)
- Dh : Housing outside diameter (mm)
(Note: If the housing is a rigid body, $Dh=\infty$.)
- $di \approx 0.1(3D+7d)$ for Cylindrical roller bearings and Self-aligning Ball bearings of bearing series 22 and 23

$di \approx 0.1(3D+7d)$ for other bearings

$De \approx 0.25(3D+d)$ for Cylindrical roller bearings and Self-aligning Ball bearings of bearing series 22 and 23

$De \approx 0.1(7D+3d)$ for other bearings

For estimating δf , the following may be used:
 $\delta f = 0.7 (\Delta de + \Delta De)$ to
 $0.9 (\Delta de + \delta De)$,

with smaller values for heavy-section bearings (e.g. bearings of diameter series 4) and larger values for light-section bearing rings. (e.g. bearings of diameter series 9)

(4) Increase of clearance due to load

When a bearing is subjected to a load, elastic deformation will occur and this deformation will cause an increase in internal clearance. Table 8.16 outlines elastic deformation δr and δa .

Table 8.16 Load and Elastic Displacement

Bearing Types	Approximation of displacement from radial load δr (mm)	Approximation of displacement from axial load δa (mm)
Self-Aligning Ball Bearings	$\delta r = \frac{0.00070}{\cos \alpha} \sqrt[3]{\frac{Po^2}{Dw}}$	$\delta a = \frac{0.00070}{\sin \alpha} \sqrt[3]{\frac{P^2}{Dw}}$
Deep groove ball bearings, angular contact ball bearings	$\delta r = \frac{0.00044}{\cos \alpha} \sqrt[3]{\frac{Po^2}{Dw}}$	$\delta a = \frac{0.00044}{\sin \alpha} \sqrt[3]{\frac{P^2}{Dw}}$
Spherical Roller Bearings	$\delta r = \frac{0.00018}{\cos \alpha} \sqrt[4]{\frac{Po^3}{Lwe^2}}$	$\delta a = \frac{0.00018}{\sin \alpha} \sqrt[4]{\frac{P^3}{Lwe^2}}$
Cylindrical roller bearings, Tapered roller bearings	$\delta r = \frac{0.000077}{\cos \alpha} \cdot \frac{Po^{0.9}}{Lwe^{0.6}}$	$\delta a = \frac{0.000077}{\sin \alpha} \cdot \frac{P^{0.9}}{Lwe^{0.6}}$
Thrust Ball Bearings	—	$\delta a = \frac{0.00052}{\sin \alpha} \sqrt[3]{\frac{P^2}{Dw}}$
Po and P	$Po = \frac{5Fr}{iz \cos \alpha}$	$P = \frac{Fa}{z \sin \alpha}$

where: Fr = Radial load (N)
 Fa = Axial load (N)
 α = contact angle(°)
 Dw = Diameter of ball or roller (mm)
 Lwe = Effective roller length (mm)
 i = Number of rows of ball or roller
 z = Number of ball or roller per row

8.2 Preload and Rigidity

Generally, rolling contact bearings are mounted so that in operation, there will be a small amount of internal clearance. Applications may sometimes require that the bearings be provided with appropriate negative clearance called "preload" when assembled. Preload has various purposes and effects. Since an incorrect amount of preload may adversely affect the rolling resistance, life, temperature rise, sound, etc. of bearings; extreme care must be taken when applying preload.

8.2.1 Purposes of Preload

- (1) Increases rigidity of a shaft (that is, preloading can help to decrease the deflection of shafting).
 - (2) Enhances rotating accuracy of shaft. Minimizes axial movements and helps to prevent vibration and decrease noise.
 - (3) Prevents fretting caused by external vibration.
- Item 1 and 2 are pertinent with respect to proper gear engagement, rotating accuracy of precision machinery and resonance of electric motor rotors.

8.2.2 Preloading Method and Measurement

- (1) Preloading method
Preloading can be accomplished using one or more of the following methods:
 - a) Use of springs (disc and coil springs) "Constant-pressure" preloading.
 - b) Use of clamping nut "Fixed-position" preloading.
 - c) Use of spacer (spacer and shim) "Fixed-position" preloading.

Fig. 8.4 Axial Load and Axial Displacement

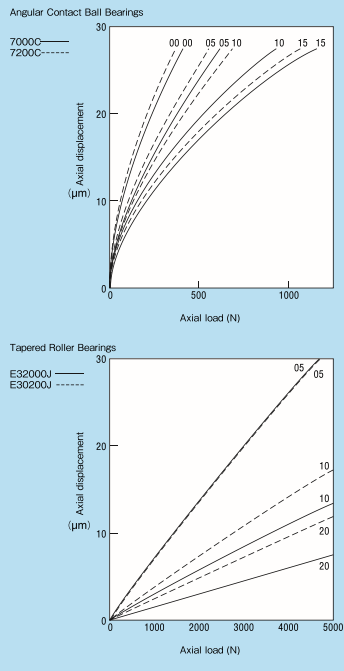
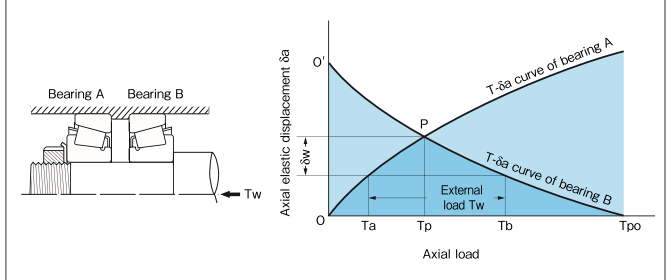

Fig. 8.5 Description of Fixed Position Preloading



- (2) Measurement of preloading amount
a) Measuring method using axial load.

- If preloading is done using springs, the preloading amount is determined by the amount of spring displacement.
- If preloading is done using a clamping nut, the preloading amount is determined by the relationship of the fastening torque of the nut and clamping force.

- b) Measuring method using the bearing axial displacement (Fig. 8.4).
Preload amount is determined by relationship of axial load on the bearing and resulting axial displacement.

- c) Measuring method using start-up friction torque of the bearing. Relationship between axial load and friction torque should be known for this method.

8.2.3 Effect of Preloading

To illustrate the effects of preloading on a duplex Tapered roller bearing set, apply the formula from Table 8.16 to calculate a set of curves for bearing A and bearing B. The example bearing set (see Fig. 8.5) is preloaded (fixed-position), and external load, T_w , is applied. Load distribution to the two units of bearing in terms of the axial displacement will be calculated using the graphical solution procedures described as follows:

- (1) Draw T- δa curve of bearing A.
- (2) Take preload T_p on axis T, determine intersection P with the curve of bearing A, and draw T- δa curve of bearing B through point P.
- (3) Connect the two curves with a length equivalent to the value of external load T_w .
- (4) Load T_a and T_b equivalent to this point will become the load of the individual bearings under external load T_w .
- (5) Disposition of bearing is obtained by the disposition δw of bearing B.

The disposition of bearing B will be obtained by subtracting disposition to Tp from the counterpart to Tb. The reason for this is that if the bearings are preloaded, the disposition of both bearings becomes constant within a range where preload is not offset to zero by an external load (O - O' in Fig. 8.5 is constant). In other words, bearing A becomes loosened by the amount displaced by the external load on bearing B. If the external load increases and preload is eliminated, load Tb on bearing B will be equal to the external load Tw and the load on bearing A becomes zero. Magnitude of the external load causing loss of preload is represented by Tpo in Fig. 8.5.

8.2.4 Duplex Bearing Preload, Clearance

The preload of duplex bearings can be defined as the clearance, 2A as shown in Fig. 8.6.

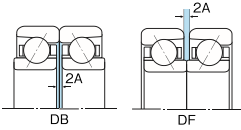

Fig 8.6

If preloading is an application necessity, it is very important that a very thorough application analysis is made, since, if an excessive amount of preload is applied, there can be abnormal heating, increase in rotating torque and / or a sharp drop in bearing life. Table 8.17 shows standard preload and Table 8.18 outlines target amount of fits for precision (tolerance class 5 or 4), Angular Contact ball bearings.

8.2.5 Thrust Bearing Minimum Axial Loads

When rotated at relatively high speeds, the contact angle between rolling elements and raceways of a thrust bearing changes due to

centrifugal force. This can cause a skidding (sliding) action between the rolling elements and the raceways. This skidding action may cause smearing and scuffing on the rolling elements and raceway surfaces.

To prevent sliding action, thrust bearings must always be loaded with a minimum axial load. The minimum axial load is derived from Formulas (8.15), (8.16) and (8.17).

Thrust bearings can sustain axial load in only one direction. When a bi-directional axial load exists, preload must be provided by either using double bearings or springs (or load washers) to maintain the minimum axial load.

For vertical shafts, the axial load due to dead weight of the shaft (etc.), will often exceed the minimum axial load. Even in such cases, reversing axial loads may occur during operation causing the initial axial load to fall below the minimum load.

(1) Thrust ball bearing (adopt larger of values below)

$$F_{a \min} = K \cdot n^2 \dots \dots \dots (8.15)$$

$$F_{a \min} = \frac{C_{oa}}{1000} \dots \dots \dots (8.16)$$

where:

- F_{a min} : Minimum axial load (N)
- K : Minimum axial load factor from Page 314.
- n : Rotating speed (min⁻¹)
- C_{oa} : Basic static load rating (N)

(2) Spherical Roller Thrust Bearing

$$F_{a \min} = \frac{C_{oa}}{1000} \dots \dots \dots (8.17)$$

Table 8.17 Standard Preload Amounts for Precision Combination Angular Contact Ball Bearings Unit: N

Bore Diameter Number	7000C (DB, DF)				7200C (DB, DF)				7300C (DB, DF)			
	E	L	M	H	E	L	M	H	E	L	M	H
00	20	50	100	145	30	70	145	195	50	100	195	295
01	20	50	100	145	30	70	145	195	50	100	195	295
02	20	50	100	145	30	70	145	195	50	100	195	295
03	20	50	100	145	30	70	145	195	50	100	195	295
04	50	100	195	295	70	145	295	490	100	195	390	590
05	50	100	195	295	70	145	295	490	100	195	390	590
06	50	100	195	390	70	145	295	590	100	195	390	685
07	70	145	295	390	100	195	490	590	145	295	590	685
08	70	145	295	590	100	195	490	785	145	295	590	980
09	70	145	295	590	100	195	490	785	145	295	590	980
10	70	145	295	590	100	195	490	785	145	295	590	980
11	100	195	390	785	145	295	590	980	195	390	785	1470
12	100	195	390	785	145	295	590	980	195	390	785	1470
13	100	195	390	785	145	295	590	980	195	390	785	1470
14	145	295	590	1170	195	390	785	1470	295	590	980	1960
15	145	295	590	1170	195	390	785	1470	295	590	980	1960
16	145	295	590	1170	195	390	785	1470	295	590	980	1960
17	195	390	785	1470	295	490	980	1960	390	785	1470	2940
18	195	390	785	1470	295	490	980	1960	390	785	1470	2940
19	195	390	785	1470	295	490	980	1960	390	785	1470	2940
20	195	390	785	1470	295	490	980	1960	390	785	1470	2940

Table 8.18 Target Interference Values for Precision (tolerance class 5 or 4) Angular Contact Ball Bearings Unit: μm

Nominal bearing bore diameter d (mm)	Shaft to inner ring		Nominal bearing outside diameter D (mm)		Housing to outer ring
	Over	Incl.	Over	Incl.	
—	18	0 ~ 2	—	18	—
18	30	0 ~ 3	18	30	2 ~ 6
30	50	0 ~ 3	30	50	2 ~ 6
50	80	0 ~ 4	50	80	3 ~ 9
80	120	0 ~ 4	80	120	3 ~ 9
120	150	—	120	150	4 ~ 12
150	180	—	150	180	4 ~ 12
180	250	—	180	250	5 ~ 15

Remark: Regarding the fit of housing and outer ring, take the smaller values of target clearance for the clamping side bearing and the larger values for the floating side.

8.3 Shaft and Housing Selection

Care must be taken in the design and manufacture of shafts and housings since inaccuracies in these components will probably result in poor bearing performance.

8.3.1 Accuracy and Surface Finish; Shafts and Housings

For general service conditions, the fit surfaces for shafts and housing bores for rolling contact bearings can be made using lathes or fine boring machines.

For applications requiring high-running accuracy, or for very quiet operation, or where high loads exist, a ground finish will be necessary.

Table 8.19 indicates the shaft and housing accuracy and surface roughness for normal service condition.

8.3.2 Shaft and Housing Design; Recommendations

- Design shafts as short as possible and of sufficient diameter to prevent bending. Design the housing and supports for appropriate rigidity.

- Use care in specifying the roundness, cylindricity, and surface finish of shaft and housing fit surfaces. See Table 8.19.
- Use care in specifying the squareness of the shaft shoulder to the shaft axis and squareness of the housing shoulder to the housing. See Table 8.19.
- Make sure that the radius, r_a , of the shaft and housing is smaller than the bearing chamfer dimension, r (minimum) or r_1 (minimum) to prevent the shaft or housing from interfering with proper bearing seating. See Fig. 8.7.

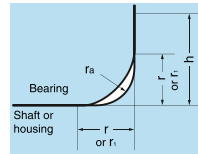

Fig. 8.7 Chamfer Dimension, fillet radius and Shoulder Height

Table 8.19 Shaft and Housing Accuracy and Surface Roughness

Item	Shaft	Housing bore
Roundness	≤ 0.5 times shaft diametral deviation	≤ 0.5 times housing bore deviation
Cylindricity	≤ 0.5 times shaft diametral deviation within range of bearing width	≤ 0.5 times bore deviation within range of bearing width
Shoulder squareness	small bearing	3/10000 or less
	medium bearing	4/10000 or less
	large bearing	5/10000 or less
Fit surface roughness	small bearing	$R_a < 0.8 \mu\text{m}$
	medium bearing	$R_a < 0.8 \mu\text{m}$
	large bearing	$R_a < 3.2 \mu\text{m}$

For radial bearings in general, determine the maximum value of fillet radius r_a and the minimum value of the shoulder height according to Table 8.20.

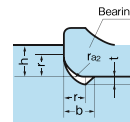

Fig. 8.8 Chamfer Dimensions and fillet radius

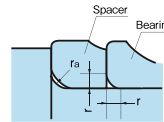

Fig. 8.9 Chamfer Dimensions and fillet radius when Using a Spacer

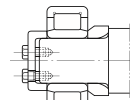

Fig 8.10

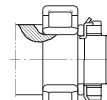

Fig 8.11

When using a ground finish, provide an undercut as shown in Fig. 8.8. See Table 8.21 for undercut dimensions.

- When using a fillet radius, (r_{a2}) larger than the bearing chamfer dimension (for enhancing the strength of the shaft or when shoulder height must be lower than specified in the dimension tables), install a spacer between the bearing and the shaft shoulder as shown in Fig. 8.9 and Fig. 8.10.
- For ease of dismounting, make the height of the shaft shoulder smaller than the inner ring outside (or land) diameter. If a higher shoulder is required for applying heavy axial load, install an undercut in the shaft as shown in Fig. 8.11.
- Finish bearing mounting screws, or clamping nuts as perpendicular to the shaft as possible and thread screws reverse to the rotating direction of the shaft.
- For split-type housings, carefully finish the matching faces of the split housing and install a relief on both sides of the bore diameter of the cap to prevent excessive force from being applied to the bearing when the housing cap is tightened.
- For light-alloy housings (having less rigidity), insert a steel bushing to provide additional rigidity.
- Generally, an interference fit is not adequate to axially locate a bearing. A shaft or housing backing shoulder should be used.

Table 8.20 Maximum Corner Radius and Minimum Shoulder Heights
Unit: mm

Minimum chamfer dimension r (min) or r_1 (min)	Shaft or housing		
	Radius r_2 (max) of corner	Shoulder height h (min)	
		Bearing application in general	Special cases (1)
0.1	0.1	0.4	0.4
0.15	0.15	0.6	0.6
0.2	0.2	0.8	0.8
0.3	0.3	1.25	1
0.6	0.6	2.25	2
1	1	2.75	2.5
1.1	1	3.5	3.25
1.5	1.5	4.25	4
2	2	5	4.5
2.1	2	6	5.5
2.5	2	6	5.5
3	2.5	7	6.5
4	3	9	8
5	4	11	10
6	5	14	12
7.5	6	18	16
9.5	8	22	20
12	10	27	—
15	12	32	—
19	15	—	—

Note: (1) Data in the columns for special cases should be used when axial load is extremely small. The values in this column do not apply to tapered roller bearings, spherical roller bearings and angular contact ball bearings.
Remark: Symbols are based on Fig. 8.7.

Table 8.21 Undercut Dimensions for Ground Shaft
Unit: mm

Minimum chamfer dimension r (min) or r_1 (min)	Undercut dimensions		
	t	r_{a2}	b
1	0.2	1.3	2
1.1	0.3	1.5	2.4
1.5	0.4	2	3.2
2	0.5	2.5	4
2.1	0.5	2.5	4
2.5	0.5	2.5	4
3	0.5	3	4.7
4	0.5	4	5.9
5	0.6	5	7.4
6	0.6	6	8.6
7.5	0.6	7	10

Remark: Symbols are based on Fig. 8.8.

8.3.3 Examples of Shaft Designs

(1) Cylindrical-bore Bearing Shaft Design

- If axial load is applied away from the shaft shoulder, the inner ring can be locked into position using; a) nuts and washers (Fig. 8.12a); b) nuts and lock plates (Fig. 8.12b); or c) end plates and bolts (Fig. 8.12c). When using a lock washer WITHOUT a shaft keyway or slot, it is recommended that the direction of the nut thread be made reverse to that of the shaft rotation.

- When not supporting axial load on the shaft-end on the side opposite the shaft shoulder, you may elect to insert a snap ring in a shaft groove to prevent the inner ring from moving axially. To remove clearance between the snap ring and bearing ring, shims or spacers can be inserted. See Fig. 8.13.
- Snap rings can be applied when using spacers between gears, or pulleys instead of using a shaft shoulder. If axial load will act on the snap ring, insert a shim or spacer between the bearing ring and the snap ring to prevent the bending stress from applying axial load to the snap ring, and to eliminate any axial clearance between the snap ring and the snap ring groove. See Fig. 8.13.

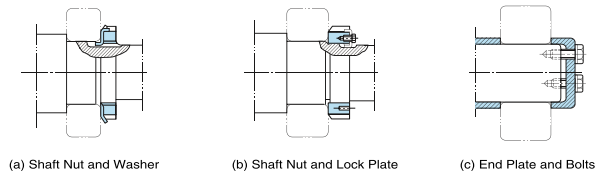

Fig 8.12

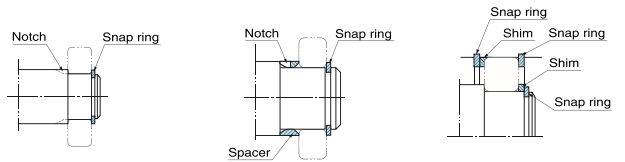

Fig 8.13

(2) Tapered-bore Bearing Shaft Designs

Two methods of mounting tapered-bore bearings to a shaft are; direct mounting to a tapered shaft, or mounting to a cylindrical shaft using an adapter or withdrawal sleeve. Use of adapter or withdrawal sleeves may allow use of less expensive shaft seats (no tapering cost), permits use of a larger shaft tolerance and allows variable location of a bearing on a shaft. See Figs. 8.14 to 8.16. Since the dimensional accuracy of sleeves is not as high as that of bearings, sleeves are not appropriate for applications requiring high accuracy or high rotational speed.

- Normally, tapered-bore bearings used with adapters do not employ shaft shoulders.

To prevent nuts from loosening, use washers for shafts of diameters 200 mm or less, and lock plates for shafts of diameters 200 mm or more. Thread direction of the nut should be made in reverse to the direction of rotation.

- For shafts with shoulders, mount the tapered-bore bearing with withdrawal sleeves with nuts and washer or end plates and bolts. See Fig. 8.17.
- When accuracy is of primary importance, use the direct mount method using tapered-bore bearings mounted directly on tapered shafts. See Fig. 8.18.

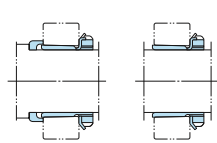

Fig. 8.14 Adapter Sleeve Mounting

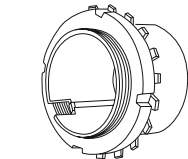

Fig. 8.15 Adapter Using Washer (Bearing Bore Diameter Number ≤ 40)

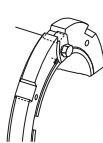

Fig. 8.16 Adapter Using Lock Plate (Bearing Bore Diameter Number > 40)

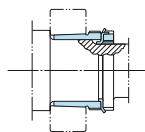

Fig. 8.17 Withdrawal Sleeve Mounting

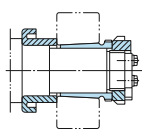

Fig. 8.18 Tapered Shaft Mounting Using Split Ring, Nut and Washer

8.3.4 Housing Designs

- When mounting two bearings to a common shaft, it is necessary to design a structure that allows linear expansion of the shaft due to temperature rise, and for mounting location errors made during assembly. To accomplish this, mount one of the bearings to support both radial and axial loads. Fix the inner and outer rings to the shaft and housing so that neither ring will move axially. Mount the other bearing so it can move axially as the "free" side bearing capable of supporting only radial load. If a bearing configuration is selected for the free side bearing which will not accommodate the linear movement of the shaft created by thermal expansion, select a housing fit which will permit axial movement of the outer ring in the housing.
- If a Cylindrical roller bearing with an N, NU, or RNU configuration is used for the free side bearing, then shaft expansion due to temperature rise can be relieved by axial movement of the inner ring of the bearing. See Fig. 8.19. Use of Cylindrical roller bearings may also facilitate assembly if an interference fit is required for both inner and outer rings (due to the load relationship).

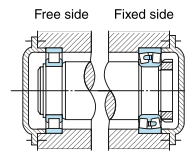

Fig. 8.19

- If Cylindrical roller bearings with an NF or NJ configuration are used at both ends of a shaft, axial clearance must be prevented

from becoming too small. Referring to Fig. 8.20, make width B (inner ring spacer) larger than the distance A between the outer rings.

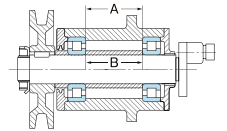

Fig 8.20

- If the amount of shaft expansion is small (due to small temperature rise or short shaft), and precise axial location is not needed then two units of non-separable configuration bearings may be used with both units having floating axial movement. In such cases, assemble the two units with axial clearance on both ends of the assembly. See Fig. 8.21. For mounting of two Deep-groove ball bearing pillow blocks with spherical outer ring bearing surfaces, lock and bolt the first pillow block into position, then lock the second block to the shaft. Pull the second block away from the first block while tightening the mounting bolts. Where axial expansion can not be handled by the clearance within the bearings, please consult NACHI.

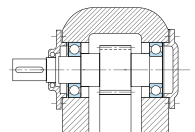

Fig 8.21

- Pairs of single-row Angular Contact ball, or Tapered roller bearings are often used for axial positioning. When bearing spacing is large, axial expansion from temperature rise is best handled using an assembly as shown in Fig. 8.22, where the paired bearings take axial and radial loads and another bearing (in the Figure, an NU-configured Cylindrical roller bearing), permits linear shaft expansion.

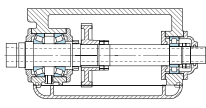

Fig 8.22

- When using horizontally-split pillow blocks as the fixed side bearing, the outer ring is located by using one or two positioning rings. When one ring is used, place it to the side of the adapter nut as shown in Fig. 8.23. When two positioning rings are used, place one on each side of the bearing (also see Fig. 8.23). To use a horizontally-split pillow block as the floating side bearing, mount the bearing without positioning rings.

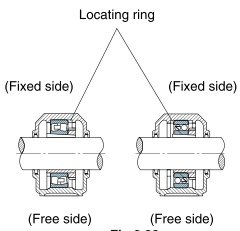

Fig 8.23

- Determine the position of the fixed bearing by considering the machinery application and the balance of rated life of the individual bearings. For example, when a bevel gear is used (see Fig. 8.24), set the bevel gear side as the fixed side to maintain the accuracy of the gear engagement. For electric motors, the fixed side bearing is often positioned on the non-driving side where a lower amount of radial load is applied, in order to equalize the bearing equivalent load and rated life between the two bearings.

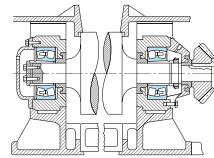

Fig 8.24

8.4 Sealing Devices

8.4.1 Sealing Device Requirements

- Must effectively stop foreign material intrusion.
- Must not create excessive frictional loss or heat.
- Must be easy to mount, dismount, and maintain.

- Must be inexpensive.



The lubrication method and sealing devices used must be compatible and appropriate for the application.

Integrally-sealed or shielded bearings may need separate, additional sealing devices if they are to be operated in an adverse atmosphere.

Type of Sealing Device	Design Example	Design Precautions						
Linear gap (simple gap type)		<ol style="list-style-type: none"> 1) Clearance between oil groove type shaft and housing Unit: mm <table border="1"> <thead> <tr> <th>Shaft dia.</th> <th>Radial clearance</th> </tr> </thead> <tbody> <tr> <td>50 or less</td> <td>0.25 ~ 0.4</td> </tr> <tr> <td>50 Over 200 Incl.</td> <td>0.5 ~ 1.5</td> </tr> </tbody> </table> 	Shaft dia.	Radial clearance	50 or less	0.25 ~ 0.4	50 Over 200 Incl.	0.5 ~ 1.5
Shaft dia.	Radial clearance							
50 or less	0.25 ~ 0.4							
50 Over 200 Incl.	0.5 ~ 1.5							
Coaxial groove (oil groove type)		<ol style="list-style-type: none"> 2) Groove dimensions Width: 3 to 5 mm Depth: 4 to 5 mm 3) Where possible, provide three grooves or more. 4) Fill grooves with grease to aid in sealing out foreign material. 5) Threaded groove type is applicable to oil lubricated applications where the shaft is horizontal and operates in constant rotational direction. Thread grooves must be reverse to the rotation direction. Therefore, they are not applicable for shafts with indeterminate direction rotation. 6) Oil grooves are used alone if there is little foreign material, as a simple method to prevent oil leaks, usually they are combined with another method of sealing. 						
Threaded groove								

Type of Sealing Device	Design Example	Design Precautions
Slinger type		<ol style="list-style-type: none"> 1) Seal types that sling oil, prevent oil leakage and dust entry through the centrifugal force generated by a rotor attached to the shaft. 2) (a) and (b) are good for preventing oil leakage. 3) (c) and (d) are good for preventing dust and water intrusion.
Oil thrower type (for oil lubrication)	<p>Oil thrower (a type of slinger)</p>	<ol style="list-style-type: none"> 1) Oil deposited in the grooves returns to the housing.

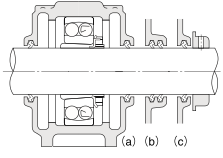
Type of Sealing Device	Design Example	Design Precautions											
Radial labyrinth type		<ol style="list-style-type: none"> 1) Labyrinth Clearance Unit: mm <table border="1"> <thead> <tr> <th rowspan="2">Shaft dia.</th> <th colspan="2">Labyrinth Clearance</th> </tr> <tr> <th>Radial direction</th> <th>Axial direction</th> </tr> </thead> <tbody> <tr> <td>50 or less</td> <td>0.25~0.4</td> <td>1~2</td> </tr> <tr> <td>50 Over 200 Incl.</td> <td>0.5~1.5</td> <td>2~5</td> </tr> </tbody> </table> 2) There are radial labyrinth and axial labyrinth types of labyrinth seals. The radial labyrinth type requires a split housing. 3) These seals are very suitable for the prevention of oil leakage of high speed shafts. 4) For low speed rotation, apply grease to the grooves for better sealing. 	Shaft dia.	Labyrinth Clearance		Radial direction	Axial direction	50 or less	0.25~0.4	1~2	50 Over 200 Incl.	0.5~1.5	2~5
Shaft dia.	Labyrinth Clearance												
	Radial direction	Axial direction											
50 or less	0.25~0.4	1~2											
50 Over 200 Incl.	0.5~1.5	2~5											
Axial labyrinth type		<ol style="list-style-type: none"> 5) If angular misalignment exists between the shaft and the housing, use self-aligning type labyrinth. 											
Self-aligning type labyrinth													

Type of Sealing Device	Design Example	Design Precautions																																										
<p>Seal ring type, (felt, leather, rubber, plastic)</p> 	 <p>(a) (b) (c)</p>	<p>1) Sealing Material Temperature Range</p> <table border="1"> <thead> <tr> <th>Sealing material</th> <th>Operating temperature range (C)</th> </tr> </thead> <tbody> <tr> <td>Nitrile</td> <td>-25~100</td> </tr> <tr> <td>Acrylic</td> <td>-15~130</td> </tr> <tr> <td>Silicon</td> <td>-70~200</td> </tr> <tr> <td>Flourine</td> <td>-30~200</td> </tr> <tr> <td>Ethylene tetrafluoride</td> <td>-50~220</td> </tr> <tr> <td>Felt</td> <td>-40~120</td> </tr> </tbody> </table> <p>2) Sealing Material Speed Limits m/s</p> <table border="1"> <thead> <tr> <th>Shaft diameter (mm)</th> <th>~20</th> <th>20~40</th> <th>40~</th> </tr> </thead> <tbody> <tr> <td>Nitrile</td> <td>4~8</td> <td>8~12</td> <td>12~16</td> </tr> <tr> <td>Acrylic</td> <td>4~12</td> <td>12~18</td> <td>18~25</td> </tr> <tr> <td>Silicon</td> <td>4~18</td> <td>18~25</td> <td>25~32</td> </tr> <tr> <td>Flourine</td> <td>4~18</td> <td>18~25</td> <td>25~32</td> </tr> <tr> <td>Ethylene tetrafluoride</td> <td colspan="3">15</td> </tr> <tr> <td>Felt</td> <td colspan="3">3.5~4.5</td> </tr> </tbody> </table> <p>These values apply when shafts have good surface finish, roundness, and run-out.</p> <p>3) Lubricate the sliding surfaces of seal and shaft.</p> <p>4) These seal types are mainly applicable to grease lubricated bearings.</p> <p>5) Install one to three pieces of felt ring.</p> <p>6) For felt rings in high speed applications, use hard seal material. Coat with mineral oil before mounting and insert tightly.</p> <p>7) Felt will harden and lose elasticity under high temperature or speed.</p> <p>8) Felt rings can prevent intrusion of small amounts of dust, for other applications it should be combined with a slinger or a synthetic rubber grease stopper that is the same size as the felt ring.</p>	Sealing material	Operating temperature range (C)	Nitrile	-25~100	Acrylic	-15~130	Silicon	-70~200	Flourine	-30~200	Ethylene tetrafluoride	-50~220	Felt	-40~120	Shaft diameter (mm)	~20	20~40	40~	Nitrile	4~8	8~12	12~16	Acrylic	4~12	12~18	18~25	Silicon	4~18	18~25	25~32	Flourine	4~18	18~25	25~32	Ethylene tetrafluoride	15			Felt	3.5~4.5		
Sealing material	Operating temperature range (C)																																											
Nitrile	-25~100																																											
Acrylic	-15~130																																											
Silicon	-70~200																																											
Flourine	-30~200																																											
Ethylene tetrafluoride	-50~220																																											
Felt	-40~120																																											
Shaft diameter (mm)	~20	20~40	40~																																									
Nitrile	4~8	8~12	12~16																																									
Acrylic	4~12	12~18	18~25																																									
Silicon	4~18	18~25	25~32																																									
Flourine	4~18	18~25	25~32																																									
Ethylene tetrafluoride	15																																											
Felt	3.5~4.5																																											
<p>Adjustable Seal type (includes metal packing, O-ring, etc.)</p> 																																												

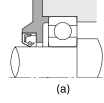
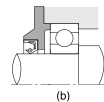
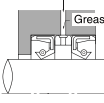
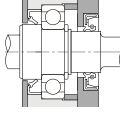
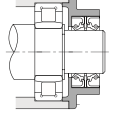
Type of Sealing Device	Design Example	Design Precautions												
<p>Oil seal type</p> 	 <p>(a)</p>  <p>(b)</p>  <p>Grease</p>  <p>Oil seal example (1)</p>  <p>Oil seal example (2)</p>	<p>1) Speed and shaft surface roughness</p> <table border="1"> <thead> <tr> <th>Speed (m/s)</th> <th>Surface Finish</th> <th>Finish method</th> </tr> </thead> <tbody> <tr> <td>~5</td> <td>Ra<0.8μm</td> <td>Paper finish after grinding</td> </tr> <tr> <td>5~10</td> <td>Ra<0.4μm</td> <td>Paper finish after grinding</td> </tr> <tr> <td>10~</td> <td>Ra<0.2μm</td> <td>Lapping, or superfinishing, or electro polishing after quenching and grinding</td> </tr> </tbody> </table> <p>2) Sliding section of shaft should be minimum hardness of HRC40, if possible hardness of HRC55 or higher is desirable.</p> <p>3) Dimensional tolerance of sliding section of shaft is h9, for seal housing it is H8 or H7.</p> <p>4) Since there are various shapes and materials for seals, select those that meet your purposes.</p> <p>5) Control the shaft and seal eccentricity, particularly eccentric movement of the shaft. Shaft eccentricity of 0.02 to 0.05 or less is desirable.</p> <p>6) Lubricate the sliding surfaces of seal and shaft.</p>	Speed (m/s)	Surface Finish	Finish method	~5	Ra<0.8μm	Paper finish after grinding	5~10	Ra<0.4μm	Paper finish after grinding	10~	Ra<0.2μm	Lapping, or superfinishing, or electro polishing after quenching and grinding
Speed (m/s)	Surface Finish	Finish method												
~5	Ra<0.8μm	Paper finish after grinding												
5~10	Ra<0.4μm	Paper finish after grinding												
10~	Ra<0.2μm	Lapping, or superfinishing, or electro polishing after quenching and grinding												

8.5 Lubrication

8.5.1 Functions of Lubrication

The main purpose of lubricants in rolling contact bearings is to reduce friction and wear of each element. Lubricants perform this function by separating rolling and sliding surfaces with a very thin film of oil. Bearing performance and service life is largely dependent on the suitability of the lubricating system and lubricant to the application. Functions of lubrication in rolling contact bearings are:

- ① Lubrication of friction surfaces:
Reduction in;
 - 1) Rolling friction between the rolling elements and raceways.
 - 2) Sliding friction between roller end and guide faces of roller bearings.
 - 3) Sliding friction between the rolling elements and retainer.
 - 4) Sliding friction between the retainer and raceway guide surface.
- ② Removal of the heat from system produced by friction and external sources. An example of the heat removal function would be use of a circulating oil lubrication system for a high-speed application.
- ③ Dust-proofing and rust prevention:
 - 1) Prevention of foreign material from entering the bearing.
 - 2) Protection of bearing components from corrosion.
- ④ Relief of stress concentration:
 - 1) Uniform distribution of stress to the rolling contact surface.
 - 2) Relief of impact loads.

8.5.2 Lubrication Cautions

- ① Adequate lubricant film separation should be maintained between friction surfaces.
- ② Since the oil film required on contact surfaces is thermally feeble, adequate oil viscosity must be maintained.
- ③ Since lubricants tend to deteriorate with increase in temperature, bearing applications should be designed to keep the operating temperature as low as possible.
- ④ The lubricating system (method) must be suitable for the application and the lubricant must have appropriate properties.
- ⑤ The lubricant must be kept free from contamination and water.

8.5.3 Lubricating Methods

(1) Oil Lubrication

(1.1) Oil Bath Lubrication

- Oil bath lubrication is generally used for low-to-medium-speed operation.
- Excessive oil causes churning which can cause excessive temperature rise. Insufficient oil will probably lead to early bearing failure.
- Oil level gauges are recommended to check (and maintain) the proper oil level.
- Separation ribs may be installed at the bottom of the housing to reduce churning and or to dissipate heat.
- Static oil level should be at slightly below the center of the lowest rolling element of a bearing applied to a horizontal shaft. See Fig. 8.25. For vertical shafts, static oil level should cover 50% to 80% of the rolling element.
- When two or more bearings are used on a vertical shaft in the same housing, the lower bearing may create excessive temperature rise if an oil bath system is used (unless operated at very low speed). If excessive heat occurs, use a drip, splash, or circulating oil system.

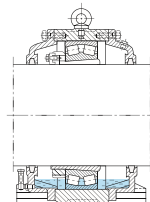

Fig 8.25

(1.2) Splash Lubrication

- In splash lubrication, oil is splashed on the bearing by a rotating element (an impeller or "slinger") mounted on the shaft. The bearing is not immersed in the oil.
- In a gear box, the gears and bearings are often lubricated from a common oil reservoir with the gears serving as a slinger. Since oil viscosity for the gears may differ from that required for the bearings and the oil may contain particles worn from the gears, a separate lubrication system or method may improve bearing life. Sealed or shielded bearings and "magnetic" plugs are often used in conjunction with gear drives.
- A bearing on a vertical shaft can be provided with a conical rotary element under the bearing so that the oil rises on the conical surface and is atomized before entering the bearing. See Fig. 8.26.

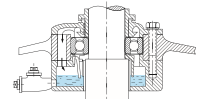

Fig 8.26

(1.3) Drip Lubrication

- Drip lubrication is used for bearings operated at relatively high speeds under low-to-medium loads.
 - Drip lubrication is generally used for the radial bearing on a vertical or inclined shaft and oil is fed directly to the bearing.
 - The lubricating oil is contained in a lubricator, and is fed to the bearing through a wick which also serves as a filter. A sight window is provided to allow checking the oil level.
- Fig. 8.27 shows a drip lubricating system provided with a lubricator on top of the housing. Oil is dripped onto the shaft nut in the bearing box, and is atomized before entering the bearing.
- Fig. 8.28 shows an oil metering system designed to feed several oil drops per minute to the bearing.

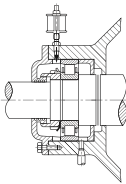

Fig 8.27

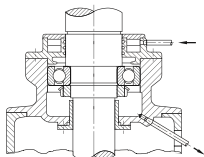

Fig 8.28

(1.4) Circulating Oil Lubrication

- Circulating oil lubrication has two purposes:
 - 1) To cool the bearing.
 - 2) To automatically feed oil to a specific area from a central system.
 - A circulating oil system consists of an oil pump, cooling device, filter and delivery piping. Circulating oil systems utilize the pumping action of the bearings and augment the cooling effects of slingers.
 - Circulating oil lubrication includes: drip, forced, and spray-mist lubrication.
 - In a circulating oil lubricating system, the bearing is provided with an oil inlet located on one side of the bearing, and an oil outlet on the other side of the bearing.
 - The oil outlet should be larger than the oil inlet so that excess oil does not remain in the bearing housing.
- Fig. 8.29 shows a circulating system with an oil passage in the area of the housing which carries no load. This system is for steam-heated calender rolls in a paper mill. Cooled oil is circulated through the inner wall of the housing and passes through both bearings.

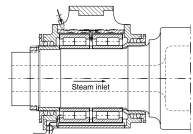

Fig 8.29

(1.5) Forced Lubrication

- Forced lubrication is used to feed oil under pressure to overcome internal housing pressure in high-speed operation.
- The oil outlet should have a cross section twice that of the oil inlet.
 - A "jet" lube system is sometimes used in high-speed applications to target oil directly to the rolling and sliding components of the bearing. See Fig. 8.30. Excessive oil should be discharged with a pump.

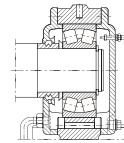

Fig 8.30

(1.6) Disk Lubrication

- Disk lubrication utilizes a disk on the shaft which rotates at high speed. The disk is partially submerged in oil, and splashes oil to an upper oil sump, which in turn delivers the oil to the bearing by gravity. Disk lubrication is used on the bearings of superchargers and blowers. See Fig. 8.31.

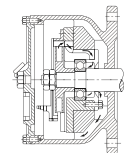

Fig 8.31

(1.7) Spray Mist Lubrication

- Fig. 8.32 shows an example of spray lubrication, which uses a turbo-compressor impeller to force oil into the bearing.
- Fig. 8.33 shows an example of oil mist applied to an oil atomizer (0.5 to 5.0 cc/h).

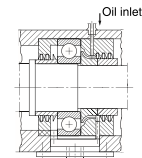

Fig 8.32

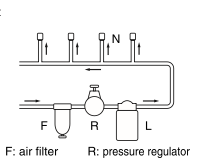

Fig 8.33

(1.8) Oil/Air Lubrication

- Using the oil/air lubrication, a very small amount of oil is mixed with compressed air with a constant-quantity piston and mixing valve. This mixture is directed to the rolling part of bearings. Because oil/air lubrication can reduce heat generation from bearings, this method is suited for high speed applications such as machine tools.

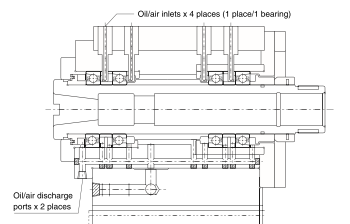

Fig 8.34

(2) Grease Lubrication

In using grease lubrication, the following items should be considered:

- Select grease having correct properties.
- Grease must be delivered in the right amount to the correct bearing area.
- Determine method of relubrication. Different greases should not be mixed because it can cause poor lubrication performance.
- Consider centralized lubrication for large-size machinery such as rolling mill equipment. See Fig. 8.35.1.

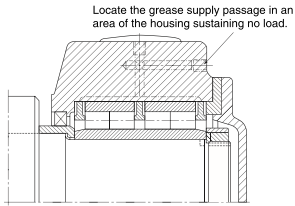

Fig. 8.35.1

Fig. 8.35.2 shows a design utilizing a grease supply plate.

8.5.4 Lubricants

Rolling contact bearings use two forms of lubricants; lubricating oil and grease. In some special applications, solid lubricants such as molybdenum-disulfide, graphite, or PTFE are used. The lubricant should have the following properties:

- Low impurity and moisture content
- Temperature stability
- Non-corrosiveness
- Load pressure resistance
- Anti-wear action
- Anti-friction action
- High mechanical stability

See Tables 8.22 for a guide to selection of lubricating oil and grease.

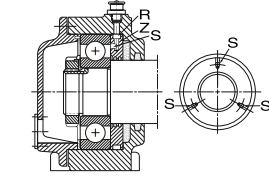

S: nozzle
R: oil groove
Z: grease sector

Fig. 8.35.2

Table 8.22 Guide to Selecting Oil and Grease

Application conditions	Grease (*)	Oil
Temperature	Not suitable for high temperature (100° to 120° C)	Suitable for high temperature (with circulating cooling)
Speed	Low to medium speeds	Suitable for high speed operation (depending on lubrication method)
Load	Light to medium loads	Suitable for high loads
Housing design	Simple	Complicated, need to consider prevention of oil leaks
Maintenance	Possible	Easy
Centralized lubrication	Not possible	Possible (Circulating lubrication provides a filter to trap dust)
Dust filtration	Large	Small (Correct oil quantity must be maintained)
Rolling resistance		

Note: (*) Grease for regular rolling contact bearings.

A wide variety of lubricating oils and greases are commercially available for rolling contact bearings. It is important to select oils or greases with base oils having an appropriate viscosity for the operating condition.

Table 8.23.1 and 8.23.2 give generally recommended viscosities for bearings under normal operating conditions.

(1) Lubricating Oil

Oils with a viscosity too low for the application may allow a partial loss of raceway to rolling element separation, leading to early bearing failure. Oils with too high a viscosity will cause an increase in torque, resulting in power loss

and abnormal temperature rise. In general, as the load increases, increase the oil viscosity. As speed of rotation increases, decrease the oil viscosity.

For Extra-small or Miniature ball bearings, low-viscosity lubricating oil will often be selected for low-torque requirements.

Table 8.23.2, and Fig. 8.36 on following pages can be used to aid in selection of appropriate oil viscosity.

Table 8.23.1 Bearing Types and Proper Viscosity of Lubricating Oils

Bearing type	Viscosity at operating temperature
Ball bearing, cylindrical roller bearing	Over 13 mm ² /s
Tapered roller bearing, spherical roller bearing	Over 20 mm ² /s
Spherical Roller Thrust Bearings	Over 32 mm ² /s

Remark: 1 mm²/s = 1cSt (centistokes)

Table 8.23.2 General Oil Selection Guide

Bearing operating temperature (°C)	dn value	ISO viscosity grade (VG) of lubricating oil (at 40 °C)		Applicable Bearing
		Normal load	Heavy or impact load	
-30~0	Up to speed limit	22 32	46	All
	Up to 15000	46 68	100	All
	15000~80000	32 46	68	All
	80000~150000	22 32	32	Except thrust ball bearings Single row radial ball bearings Cylindrical Roller Bearings
0~60	150000~500000	10	22 32	All
	Up to 15000	150	220	All
	15000~80000	100	150	All
	80000~150000	68	100 150	Except thrust ball bearings Single row radial ball bearings Cylindrical Roller Bearings
60~100	150000~500000	32 46	68	All
	Up to speed limit		320	All
100~150	Up to speed limit		46 68	Spherical Roller Bearings
0~60	Up to speed limit		150	
60~100	Up to speed limit			

Remarks: 1. This table is a guide to oil selection based on JIS K 2001 classification of Industrial Lubricating Oil Viscosity.
2. Generally as load increases or speed decreases oil with a higher viscosity is used.
3. This table is a guide for oil bath lubrication and circulating oil lubrication.
4. For information on operating conditions beyond those of this table, contact NACHI.

Fig. 8.36 Viscosity-Temperature Line Diagram

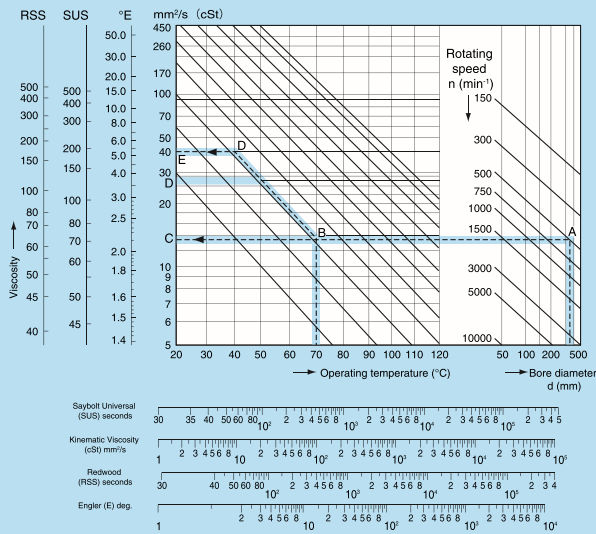

Example: Bearing Type : Cylindrical roller bearing
 Bearing bore : 340 mm
 Rotating speed : 500min⁻¹
 Operating temp : 70°C
 Required viscosity during operation (70°C) is determined by finding the intersection at A of rotating speed (500 min⁻¹) and bore (340 mm), then following a horizontal line from A to C for 13 mm²/s.
 Then find the intersection B of a straight line AC from 40°C, base temperature specified by ISO Viscosity Grade (VG), to 70°C, then draw a slanted line passing through B parallel to the viscosity operating temperature graph, find the point where the line intersects the 40°C line, for a viscosity value of 40 mm²/s.
 As a result, VG46, which satisfies a minimum 40 mm²/s, should be selected.

(2) Lubricating Grease

Lubricating grease is composed of a base oil, a thickener, and additives.

• Base Oil

Base oil refers to the liquid lubricant carried by a thickener. Mineral oils are widely used as the base oils for grease. Synthetic oils such as diester or silicone oil are also used for improving the heat resistance and stability of grease. In general, grease with a low-viscosity base oil is suitable for low temperatures and or low loads, while grease with a high viscosity base oil is suitable for high temperatures and or high loads.

Since lubricating performance is dependent on the thickener, additives, and viscosity, these components must be carefully selected to meet operating conditions.

• Thickener

The thickener has a sponge-like structure composed of a loose combination of fine fibers or particles. Thickeners are roughly divided into metal soap, and non-soap types as shown below.

Sodium (Na) soap grease may react with water to form an emulsion, and should not be used for bearings operating in a high-moisture environment.

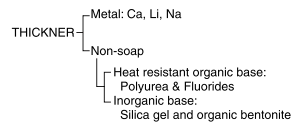

• Additives

An additive is an agent that imparts performance enhancing properties to a grease, such as extreme pressure, rust resistance, anti-oxidation performance, or other properties.

Anti-oxidant additives protect grease from oxidation and deterioration under thermal influence over a long period. Extreme pressure additives improve load resistance and impact resistance. Rust preventive additives protect the bearing and other surrounding components against rusting.

• Penetration

Penetration is a measure which indicates the solidity of grease. A measurement device has a cone with a specified weight and shape. The cone is penetrated into the sample grease for a specified time. Penetration is the depth to which the cone penetrates (in units of 1/10 mm).

Table 8.24 Grease Number and Penetration

NLGI No.	Penetration (ASTM Worked)
0	355~385
1	310~340
2	265~295
3	220~250
4	175~205
5	130~160
6	85~115

• Dropping Point

Dropping point is the temperature at which a grease sample drops through a specified hole size after being heated and fluidized.

(3) Lubrication Amount

① Oil

When oil bath lubrication is being used and a bearing is mounted with its axis horizontal, oil should be added until the static oil level is at the center of the lowest bearing rolling element. For vertical shafts, add oil to cover 50% to 80% of the rolling element.

② Grease

The rolling bearing and bearing housing should be filled until the grease occupies about 33 to 50 % of the respective volumes. Temperatures will tend to rise as speed increases (due to churning). Higher-speed operation will be more sensitive to excess grease fill, so it follows that at higher dmn values, the grease-fill quantity must be reduced.

a) Amount of Initial Grease Fill

The amount of initial grease-fill required is calculated from the following equations:

Ball bearing:

$$Q = \frac{d^{2.5}}{900} \dots\dots\dots (8.18)$$

Roller bearing:

$$Q = \frac{d^{2.5}}{350} \dots\dots\dots (8.19)$$

where:

Q=Amount of filling grease (g)
 (specific gravity of grease=0.9)
 d=Bore diameter of bearing (mm)

b) Relubrication Amount Added at Service

$$Q = 0.005 \times D \cdot B \dots\dots\dots (8.20)$$

where:

Q=Amount of grease to add (g)
 (specific gravity of grease=0.9)
 D=Outside diameter of bearing (mm)
 B=Inner ring width (mm)

③ Lubrication Interval

For a typical bearing, which operates at about 50°C, lubricant should be replaced once a year. If operating temperature is 100°C or more, the lubricant should be replaced more than once every three months even if it has good heat stability. If oil bath lubricant becomes contaminated by water or foreign particles, it must be replaced immediately. The grease relubrication interval can be estimated from Fig 8.37.

④ Grease Service Life

For applications where relubrication is not possible or practical, grease service life may be estimated using Formula (8.21). The following formula was derived using a grease with Lithium thickener and mineral oil base.

$$\log L = (0.018f - 0.025)T - 2.77f + 6.3 \dots\dots\dots (8.21)$$

where:

L=Grease life (h)
 f=(Operating speed) (min⁻¹) / (Bearing grease speed limit) (min⁻¹)
 If f is less than 0.25, f is set=0.25
 T=Operating temperature (°C)
 If T is less than 30°C, T is set=30.

Fig 8.37 Grease lubrication interval

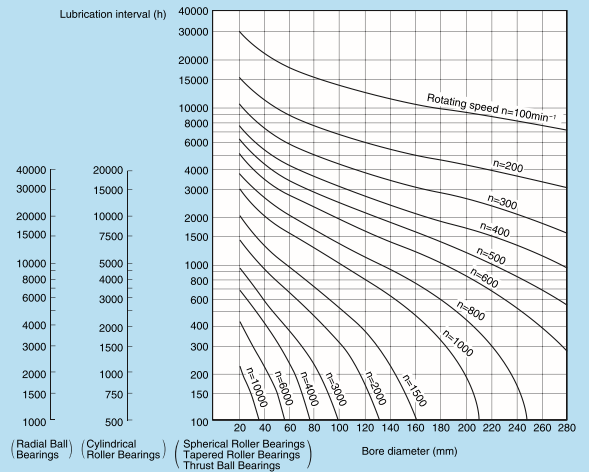

Table 8.25 Grease Properties

Popular name Thickener Base Oil	Cup Grease		Fiber Grease		Aluminum Grease	General-purpose Grease	Diester Grease	Silicone Grease	Mixed Base Grease	Complex Grease	Non-Soap Base Grease	
	Ca Soap	Na Soap	Al Soap	Li Soap			Ca + Na Soap, etc.	LI Complex Soap, etc.	Bentonite, Urea, Fluorine, etc.	Mineral Oil	Synthetic Oil	
Properties	Mineral Oil	Mineral Oil	Mineral Oil	Mineral Oil	Diester Oil	Silicone Oil	Mineral Oil	Mineral Oil	Mineral Oil	Mineral Oil	Mineral Oil	Synthetic Oil
Visual appearance	Like butter	Fibrous or like butter	Stringy or like butter	Like butter	Fibrous or like butter	Like butter	Fibrous or like butter	Like butter	Fibrous or like butter	Like butter	Like butter	Like butter
Dropping point (°C)	85	160 or higher	85	170 or higher	200 or higher	150 or higher	200 or higher	250 or higher	200 or higher	200 or higher	250 or higher	250 or higher
Operating temperature range (°C)	-20~+70	-10~+120	-10~+80	-30~+120	-50~+130	-50~+170	-30~+120	-30~+140	-10~+130	-50~+200	-50~+200	-50~+200
Water Resistance	Good	Not possible (emulsification)	Good	Good	Good	Good	Not possible (for Na)	Good	Good	Good	Good	Good
Mechanical Stability	Fair	Good	Fair	Good	Good	Good	Good	Good	Good	Good	Good	Good
Remarks	Contains small amount of moisture for structure stability. Not suitable for use at high temperature.	Cannot be used with water or moisture due to emulsification with water. Used at relatively high temperature.	Used in vibrating conditions due to good tackiness.	General purpose grease. Widely used with small and medium size ball bearings.	Suitable for low temperature operation.	Wide working temperature range. Mainly used for light load conditions.	Used for large size bearings.	Suitable for high temperature operation and heavy load conditions.	Wide working temperature range. Depending on combination of thickener and base oil used, good high temperature, low temperature or chemical stability can be obtained.			

Remarks: 1. Greases with sodium (Na) soap thickener can not be used in applications where there is a risk of water or high humidity because they emulsify and flow out if they mix with water.
 2. In case of mixing different brands of grease (not recommended), please consult the grease manufacturer to determine if there are any detrimental effects.
 3. In case operating temperatures are beyond what are shown in the table, please consult NACHI.

8.6 Speed Limit

- Bearings exceeding a certain operating speed will begin to create internal heat which may not be controllable.
- Speed limits vary with bearing types, dimensions, lubrication system, internal design of the bearing, and working loads. In addition, speed limits will vary according to the type of integral bearing seal which may be used (dependent on the speed of the seal contact area).
- The term "speed limit" refers to the estimated speed, in revolutions per minute, at which bearings will remain serviceable.

The dimension tables show speed limits for both grease and oil lubrication. Please note that the published speed limits are based on operation of properly lubricated, lightly-loaded bearings, installed on a horizontal shaft.

8.6.1 Speed Limit Correction for Load

As noted above, bearing speed limits will vary with respect to load. Figs. 8.38.1 and 8.38.2 allow calculation of a speed limit correction factor which is applied to the speed limit tables.

- In Fig. 8.38.1, Cr is the basic dynamic load rating and P is the equivalent dynamic load. If Cr/P is < 13, then the table speed limit is multiplied by the correction factor from the curve shown in Fig. 8.38.1.
- In addition, if the ratio of the axial load (Fa) to the radial load (Fr) is larger than 0.3, that is, if Fa/Fr > 0.3, then the speed limit must be FURTHER multiplied by a correction factor as shown in Fig. 8.38.2
- Where the bearing is used at 75% or more of the speed limit, lubrication becomes a more sensitive operating consideration. If grease is to be used, then selection of the correct

Fig. 8.38.1 Correction Factor for Bearing Load

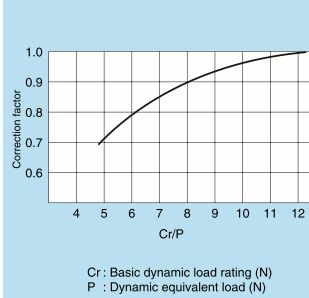
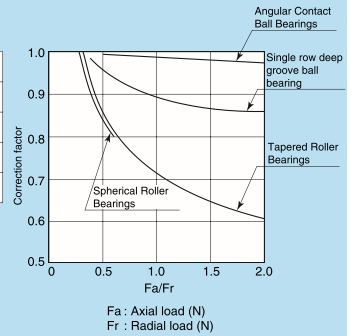

Fig. 8.38.2 Correction Factor for Fa/Fr



type and amount of grease is of paramount importance. If oil is used, then the correct selection of the feeding method and rate, and oil specification is of extreme importance.

- Please contact NACHI for help in cases where application rotating speed exceeds the corrected bearing speed limit.
- If the bearing is used in excess of the corrected speed limit, consideration must be given to the accuracy and clearance of the bearing; and to the material and shape of the retainer. Table 8.26 provides a guideline for maximum speed for bearings using special cages and internal design.

Table 8.26 Correction of Allowable Speed Limit in High-speed Operation

Bearing Type	Correction factor
Deep Groove Ball Bearings	2.5
Angular Contact Ball Bearings	2
Cylindrical Roller Bearings (single row)	2.5
Tapered Roller Bearings	2
Spherical Roller Bearings	1.5

8.7 Friction and Temperature Rise

8.7.1 Friction Torque

Friction torque in rolling bearings will vary with the bearing load and the condition of the lubricant.

Where the bearing load is light-to-normal ($P \leq 0.12C$) and the lubricant provides good separation between the rolling contact surfaces, bearing friction torque may be calculated using the following formula:

$$M = \mu \cdot F \cdot \frac{d}{2} \dots\dots\dots (8.22)$$

where:

- M : friction torque (N·mm)
- μ : coefficient of friction
- F : bearing load (N)
- d : shaft diameter (mm)

The coefficient of friction for various bearing types is shown in Table 8.27.

8.7.2 Temperature Rise

• Temperature rise in bearings is caused by the conversion of friction energy into heat.

• Bearing temperature will generally rise quite abruptly during the initial stage of operation and then gradually climb until a steady state is reached. The steady state condition will exist if temperature rise from frictional energy is removed by the cooling "heat-sink" effect from the shaft and housing, and from heat conduction via the shaft, housing and lubricant.

• The time until equilibrium is attained depends on the difference between heating volume generated by the bearing and the heating volume removed by the cooling effect.

• If the equilibrium temperature is excessively high, then review of the bearing application should be done. The bearing internal clearance or preload, fits, bearing support structure, seal contact area surface finish, rotating speed, load, and lubrication type, amount, and delivery system are subjects for investigation where excessive temperature occurs.

• An abnormal temperature rise can cause a spiraling condition where no equilibrium will occur, thus leading to a break-down in the lubricant and lubricant film, with catastrophic results.

Table 8.27 Coefficient of Friction

Bearing Types	Coefficient of friction (μ)	Load conditions
Single row Deep-groove Ball Bearings	0.0010~0.0015	Radial load
Single row Angular Contact Ball Bearings	0.0012~0.0018	Radial load
Cylindrical Roller Bearings	0.0008~0.0012	Radial load
Tapered Roller Bearings	0.0018~0.0025	Radial load
Self-Aligning Ball Bearings	0.0008~0.0012	Radial load
Spherical Roller Bearings	0.0020~0.0025	Radial load
Thrust Ball Bearings	0.0010~0.0015	Axial load
Spherical Roller Thrust Bearings	0.0020~0.0025	Axial load

8.8 Mounting and Dismounting

Rolling bearings have higher accuracy than other parts in most equipment and are often considered to be the most important rotating component. Improper handling of bearings reduces machine accuracy and can cause early bearing failures. To attain predicted bearing performance, utmost care should be taken in handling bearings from the point-of-receipt through the mounting operation.

8.8.1 Storage and Handling

The major problems encountered during bearing storage and handling operations are in rusting and impact damage to the parts.

- To protect bearings against rusting during storage, parts should be placed in a dry, clean, cool area. Bearings should not be subjected to extremes of humidity during storage.
- Impact to bearings can create damage to the raceways, rolling elements, and cages. Do not drop bearings. Bearings which are dropped should not be used for service.

8.8.2 Mounting

Proper bearing mounting governs the life, accuracy, and performance of a bearing. Before mounting the bearing, carefully check the following points.

Check to see if:

- the job standards are established and the necessary jigs are prepared.

- the shaft and housing size, tolerance, and finish are defined and met.
- lubricant type and amount specified is at hand.
- inspection standards are established.
- the method of cleaning the bearing and relevant parts is defined and understood.

(1) Mounting Precautions

- Select a clean, dry place to handle the bearing, and keep necessary tools and workbench clean.
- Do not unpack the bearing until it is to be mounted.
- If the bearing is unpacked before mounting for acceptance inspection or for any other reason, follow these directions:
 - a) If the bearing is to be mounted within a short time period, coat it with rust preventative oil and place it in a clean container.
 - b) If the bearing will not be mounted in a short time, coat it with rust preventative oil and repack it in the original container.
- Check to see that the lubricant drums, cans, tubes, or applicators are clean and/or closed. Check to be sure that the bearing housing is clean and free from flaws, impressions, burrs, or any other defects.
- For grease lubrication, you may fill the new bearing with grease without cleaning the bearing. If the bearing is small or is used for high-speed operation, whether it is lubricated

with oil or grease, wash the bearing with clean kerosene or warm, light oil to remove the rust preventative. However bearings with seals or shields must not be washed and heated.

If gear oil is used for lubrication, clean the bearing to remove any rust preventative oil.

(2) Shaft

- Before mounting the bearing on the shaft, check to see that the shaft is finished to the specified size and accuracy.
- Check the shaft for surface finish. If the shaft fit surface has a poor surface finish (see Fig. 8.39), the surface may be smoothed during mounting, possibly resulting in bearing ring creep, shaft wear, and early bearing failure.
- Be sure that the shaft shoulders are finished perpendicular to the shaft axis, otherwise the bearing will be misaligned resulting in early bearing failure.
- Finish the corner radius of the shaft to the specified dimensions. Make sure the corner radius of the shaft is slightly smaller than that of the bearing as shown in Fig. 8.40. Never have the corner radius of the shaft larger than that of the bearing (see Fig. 8.41), otherwise, the bearing ring may be misaligned and early bearing failure will occur.
- Out-of-roundness of shaft
Make sure that the shaft is accurate to out-of-roundness and cylindricity specifications. The inner ring of the bearing is an elastic body, having a relatively thin wall, so if the inner ring is fitted to a shaft having poor roundness, the inner ring raceway will be deformed accordingly.
- Contact surface of oil seals
When using an oil seal, finish the seal contact surface to $Ra < 0.8 \mu\text{m}$. If the finish is rougher than $Ra < 0.8 \mu\text{m}$, the seal will gradually wear until it has no sealing effect. Also make sure that the contact surface is within the runout

tolerance, otherwise oil leaks may occur since the seal lip may not stay in contact with the rotating shaft. (See Page 113).

(3) Bearing Housing

- Purposes of the bearing housing are:
 - a) to maintain the bearing position for load support.
 - b) to protect the bearing from the intrusion of foreign material.
 - c) to provide a structure that will keep the bearing well lubricated.
- Verify that the housing bore diameter is to design specifications. If a loose fit class of H or looser is specified, check to make certain that the bearing will move freely in the bearing housing during installation. On horizontally-split bearing housings such as used on pillow blocks, do not mix the caps and bases during a reassembly procedure since these parts are mated during manufacture. In the latter case, mixing may cause either pinching or looseness of the bearing.
- Allowance must be made for linear expansion of the shaft due to temperature rise. When two or more bearings are mounted on a single shaft, comply with the following directions: Fix one bearing in the axial direction in the housing, and make sure that the other bearing(s) are free to move in an axial direction.

(4) Accessory Mounting Parts

Prior to bearing mounting, gather a set of the parts required for the mounting job. These accessory parts may include washers, adapters, withdrawal sleeves, spacer rings, slingers, oil seals, O-rings, shaft nuts, and snap rings for the shaft and/or housing bore. Thoroughly clean these accessory parts and check them for appearance and size.

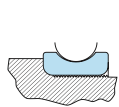

Fit surface roughness
Fig 8.39

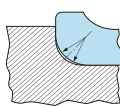

Corner radius of shaft (good)
Fig 8.40

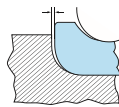

Corner radius of shaft (poor)
Fig 8.41

Other Precautions

- Be sure that the side of the shaft nut is perpendicular to the thread, otherwise, when tightened, the side of the shaft nut will make uneven contact with the side of the bearing causing early bearing failure. Use particular care when the bearing is used for high-accuracy applications such as machine tools.
- Check washers and spacer rings for parallelism of both sides.
- The oil seal and O-ring may create a temperature rise because the contact force is too great or because they are initially dry. Apply oil or grease to the contact surfaces to help prevent premature wear and reduce torque.

8.8.3 Bearing Mounting Considerations

When pressing a bearing into position, press against the ring with interference fit. Pressing through the rolling elements will cause damage, such as brinell marks or cracks to the elements and rings making the bearing unusable.

For inner ring rotating loads, the bearing is generally interference-fit to the shaft and either expansion fitting or press fitting can be used. Thermal expansion fitting may be the more appropriate method for mounting larger bore bearings.

A tapered-bore bearing can be mounted directly to a tapered shaft or with an adapter or withdrawal sleeve. When a withdrawal sleeve is used for larger bore bearings, the hydraulic mounting procedure will facilitate the process. Note that the use of hydraulic mounting of bearings to tapered journals is also very useful for larger bearing sizes.

For an outer ring rotating load, the bearing is usually interference-fitted with the housing. Either press fitting or shrink fitting may be used. In the case of the latter process, the bearing or bearing outer ring may be cooled to attain the fit.

(1) Mounting Cylindrical-bore Bearings

• Press fitting

Many cylindrical-bore bearing applications use press fitting with the shaft. Use a jig which matches the inner ring as shown in Fig. 8.42. Press fit the inner ring using a press or jack.

To press fit the inner and outer rings simultaneously, use a jig as shown in Fig. 8.43. Apply high-viscosity oil to the shaft and the contact faces of the bearing before press fitting.

• Thermal expansion Fitting

Thermal expansion fitting is an appropriate procedure for mounting larger bore bearings.

This fitting procedure can be completed quickly without applying undue stress to the ring being fit. The ring may be heated using a heating tank or an induction heater. Bearing rings must not be heated to a temperature exceeding 120°C.

Fig. 8.44 provides the amount of heat rise required, vs. bore size.

After mounting a heated bearing, secure it in the required position otherwise the bearing will tend to move axially as it cools.

Caution: When fitting rings onto a shaft or into a housing using the thermal expansion method, be sure that the procedure can be completed smoothly and quickly. If the ring should misalign or stop movement before it has reached the desired position, it may be very difficult to reposition the ring to the correct location.

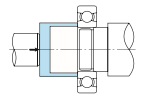

Fig. 8.42 Press Fitting of Inner Ring

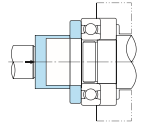

Fig. 8.43 Simultaneous Press Fitting of Inner Ring

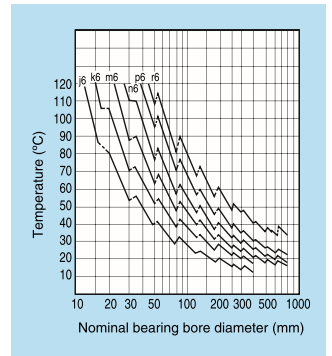

Fig. 8.44 Relationship between Required Bearing Temperature and Fit

(2) Mounting Tapered-bore Bearings

Using a split-sleeve adapter permits the mounting of tapered-bore bearings in any axial position on shaft but care must be taken to ensure that the bearing will be located at the correct position.

To mount a tapered-bore bearing using an adapter sleeve, first mount the bearing which is to be the stationary (fixed) bearing. Define and record the distance which the free bearing is expected to move in an axial direction in the housing.

Mount the free bearing so that the axial clearance provided for axial travel of the outer ring of the free bearing is on the outboard side (side farthest from the stationary bearing).

The required interference fit for tapered-bore, Spherical roller bearings can be attained using one of two methods:

- a) by driving the bearing onto the sleeve by a predetermined distance; or,
- b) by measurement of residual bearing internal clearance as the sleeve is pushed into the bearing inner ring (see Table 8.28). Since exact measurement of the axial drive-up distance is extremely difficult, the residual method is usually the method of choice.

The residual clearance method involves measuring the bearing unmounted internal clearance and then driving up the adapter sleeve until the measured clearance (the residual) = the unmounted (original) clearance - the reduction amount required to attain the correct interference fit (see Table 8.28 for the reduction amount). Clearance measurements are made using a thickness (feeler) gauge. (Note that the thickness gauge should be inserted over two or three unloaded rollers on each row of rollers and that the bearing bore must be in a horizontal position with respect to

the shaft axis, with the outer ring centered over the rolling elements).

Table 8.28 shows axial movement and radial clearance reduction for the mounting of Spherical roller bearings.

Heating of larger tapered-bore bearings may be used in conjunction with measurement of travel distance but be sure to check the results using the residual clearance method (taking the unmounted clearance measurements and the final, residual clearance, when the bearing is cool). Also be sure that the bearing is not heated to over 120°C.

When using a withdrawal sleeve for large-bore bearings, use of a hydraulic assist procedure is recommended. See Fig. 8.45 which shows use of a hydraulic nut.

(3) Other Mounting Precautions

- For paired Tapered roller bearings, be sure to adjust the axial clearance to the specified value using shims where necessary.
- For bearing types with separable inner and outer members such as Cylindrical or Tapered roller bearings, mount the inner and

Table 8.28 Tapered Bore Spherical Roller Bearings: Axial Movement and Radial Clearance Reduction mm

Nominal bearing bore diameter d (mm)	Radial clearance reduction		Axial movement				
	Over	Incl.	1/12 Taper		1/30 Taper		
	Min	Max	Min	Max	Min	Max	
30	40	0.020	0.025	0.35	0.4	—	—
40	50	0.025	0.030	0.4	0.45	—	—
50	65	0.030	0.040	0.45	0.6	—	—
65	80	0.040	0.050	0.6	0.75	—	—
80	100	0.045	0.060	0.7	0.9	1.75	2.25
100	120	0.050	0.070	0.75	1.1	1.9	2.75
120	140	0.065	0.090	1.1	1.4	2.75	3.5
140	160	0.075	0.100	1.2	1.6	3.0	4.0
160	180	0.080	0.110	1.3	1.7	3.25	4.25
180	200	0.090	0.120	1.4	1.9	3.5	5.0
200	225	0.100	0.140	1.6	2.2	4.0	5.5
225	250	0.110	0.150	1.7	2.4	4.25	6.0
250	280	0.120	0.170	1.9	2.7	4.75	6.75
280	315	0.130	0.190	2.0	3.0	5.0	7.5
315	355	0.150	0.210	2.4	3.3	6.0	8.25
355	400	0.170	0.230	2.6	3.6	6.5	9.0
400	450	0.200	0.260	3.1	4.0	7.75	10.0
450	500	0.210	0.280	3.3	4.4	8.25	11.0

outer ring separately and carefully assemble the shaft into the housing while making sure that no damage occurs to the inner or outer rings or rolling elements.

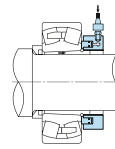

Fig 8.45 Hydraulic Nut

8.8.4 Mounting and Dismounting Force

An approximate force necessary to install or remove an inner ring from a shaft may be calculated using the following equation.

$$K_a = f_k \cdot f_e \cdot \Delta d_e \dots \dots \dots (8.23)$$

where:

K_a : Mounting or dismount force (kN)

Δd_e : effective interference (mm)

f_k : factor from Table 8.29

f_e : from following equation

$$f_e = B \cdot \left[1 - \left(\frac{d}{d_i} \right)^2 \right]$$

where:

B : inner ring width (mm)

d : inner ring bore diameter (mm)

d_i : mean inner ring outside diameter (mm)
 $d_i \approx 0.25 (D+3d) \dots$ for Cylindrical roller bearings and Self-aligning Ball bearing series 22 and 23

$d_i \approx 0.1 (3D+7d) \dots$ for other bearings

where

D : Bearing outside diameter

Table 8.29 f_k value

Conditions	f_k (1) (average)
Inner ring pressed to cylindrical shaft	39
Inner ring pulled from cylindrical shaft	59
Inner ring press fit to tapered shaft or sleeve	54
Inner ring pulled from tapered shaft	44
Tapered sleeve press fit between shaft & bearing	98
Tapered sleeve pulled from between shaft & bearing	108

Note: (1) Shaft and bearing bore thinly coated with oil.

Fig. 8.46~8.49 show dismount and press fit force by diameter series.

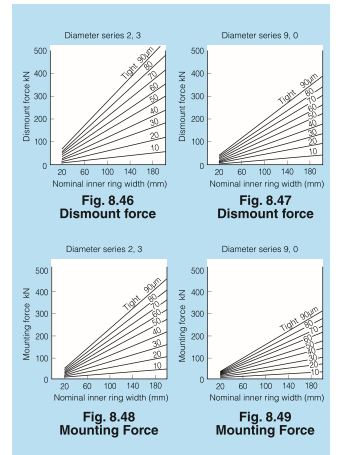

Fig. 8.46 Dismount force, **Fig. 8.47 Dismount force**, **Fig. 8.48 Mounting Force**, **Fig. 8.49 Mounting Force**

8.8.5 Operation Inspection

Verify satisfactory service with a test run. General precautions for a test run are:

- Make sure that all drive covers are in place, all bolts and nuts are tight, and appropriate clearance is provided between the shaft and all stationary parts.
- If possible, manually turn the shaft to see if there is rubbing or abnormal noise.
- If the machine is large and the shaft cannot be turned by hand, start the machine at as low speed as possible and check for rubbing or abnormal noise while coasting the machine.
- If no trouble is found during the above checks, run the machine at the design speed until attaining a steady-state temperature.
- Recheck bolt and nut tightness. Check for oil leaks, and abnormal noise. If possible, extract a sample of the oil and check it for foreign matter.
- Begin regular operation.

If trouble is encountered during machine operation, refer to Section 9, "Trouble-shooting Bearing Problems".

8.8.6 Dismounting

Bearings may be dismantled for periodic machine inspection, or when machine break down has occurred. The condition of all rotating parts and interfaces should be checked and recorded to collect data for operating improvements. The recording of data is essential where a part failure has occurred to enable a solution to any existing trouble.

In dismantling the bearing, check to see:

- If the bearing is satisfactorily mounted. (Bolts, and nuts tightened, interference of slinger with bearing housing, etc.)

- If there is (was) an adequate lubricant supply. Check for lubricant contamination and sample for residue.
- That the inner and outer ring have retained the fits as mounted.
- If the bearing clearance is as specified. If possible, measure the clearance of the mounted bearing.
- The condition of the bearing.

Before starting to dismount a bearing, review the following points:

- Dismount method
- Fit conditions
- Jigs required for dismantling
 - Press (Fig. 8.50)
 - Spanner wrench (Fig. 8.51)
 - Puller (Fig. 8.52)
 - Special puller (Fig. 8.53)
 - Holder (Fig. 8.54)

To dismount a Cylindrical roller bearing, the inner ring may be locally heated with an induction heater to facilitate removal from the shaft. (See Fig. 8.55.)

For large-bore bearings, which are often difficult to dismount, a hydraulic nut or oil injector system is recommended. See Fig. 8.45 and Fig. 8.56 respectively.

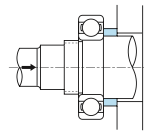

Fig. 8.50 Dismounting Bearing Using Press

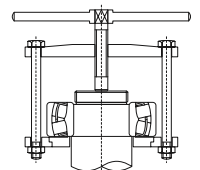

Fig. 8.53 Dismounting Bearing with Special Puller

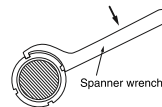

Fig. 8.51 Dismounting Bearing with Spanner Wrench

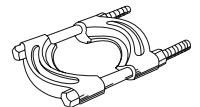

Fig. 8.54 Puller Attachment

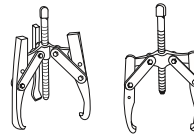

Fig 8.52

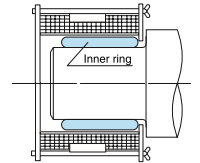
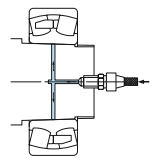

Fig. 8.55 Inner Ring Removal with Induction Heater



Dismounting Bearing with Oil Injector
Fig. 8.56

9. Trouble-shooting Bearing Problems

Rolling contact bearings must be carefully handled, mounted, and maintained in order to operate satisfactorily. The cause of unsatisfactory operation must be determined to prevent recurrence. There are three categories of data which should be gathered to enable the correct diagnosis of bearing problems:

- Time of occurrence.
 - Symptoms during operation.
 - Condition of bearing.
- Although the origin of bearing problems can sometimes be determined using data from only one of the data categories, quick and accurate analysis requires as much data as possible. See Tables 9.1, 9.2 and 9.3.

Table 9.1 Diagnosis According to Time that Bearing Problem Occurs

Time of Occurrence	Cause	Bearing selection	Design or manufacture of housing or other parts	Lubricant type, system or amount	Defective bearing	Bearing installation	Seal failure
Soon after installation		○	○	○	○	○	
Soon after periodic disassembly				○		○	
Soon after re-lubrication				○			
After replacement or repair of shaft, housing or other parts			○	○		○	
During normal operation							○

Table 9.2 Diagnosis According to Abnormal Conditions Occurring During Operation

Operating condition	Cause	Remarks
Noise	Low metallic sound.	Check with audiophone, vibration pickup, etc.
	High level metallic sound.	
	Irregular sound.	
Ever-changing sound	Change of clearance due to temperature rise. Defect in progress on raceway.	
Abnormal temperature rise.	Loss of clearance, creep, insufficient or excess lubricant, excess load.	Use a surface thermometer.
Reduction in accuracy.	Raceway or rolling element damaged by impurities, or insufficient lubricant.	Example: Lathe: stick-slip marks. Grinder: wavy pattern. Cold roll mill: oscillating wave pattern.
Unstable operation.	Damaged raceway, rolling element. Foreign matter. Excess clearance.	Example: Electric fan: extreme vibration. Power saw: impact to support. Internal combustion engine: Vibrating crankshaft.
Contaminated lubricant.	Poor lubrication, foreign matter, long term wear.	

Table 9.3 Symptoms and Countermeasures of Bearing Problems (examples indicated)

(1) Premature Flaking

The repeated heavy stress cycle between the bearing raceway and rolling element surface results in fatigue cracks which become loosened from bearing materials.

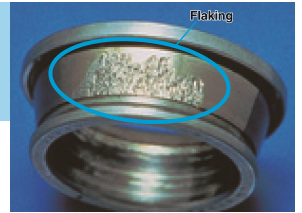

Causes

- Abnormal axial load or excessive load caused by expanded shaft.
- Deflection or misalignment of shaft.
- Poor parallelism of inner and outer rings.
- Poor lubrication.
- Rusting, Nicks, Galling from dirt, etc.

Countermeasures

- Clearance fit for the outer ring of one bearing to allow the floating end to move freely axially.
- Correct alignment of shaft and bearing housing.
- Improve mounting and alignment.
- Carefully clean and handle shaft and housing.
- Review type and quantity of lubricant.

(2) Seizure

Bearing is seized up by excessive heat. Discoloration, softening and fusion of raceway and rolling element.

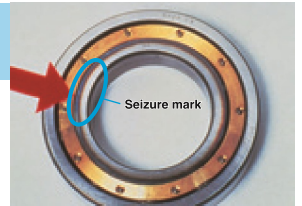

Causes

- Loss of clearance.
- Operating over limiting speed.
- Poor or improper lubricant.

Countermeasures

- Review fitting and bearing clearance.
- Review type of bearing.
- Select a proper lubricant, and feed it in proper quantity.

(3) Breakage

Splits and cracks in the inner/outer ring or rolling element.

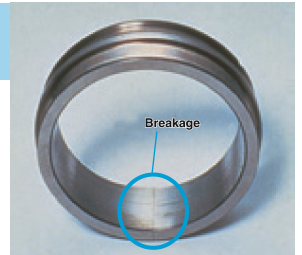

Causes

- Excessive interference fit.
- Bearing seat has larger corner radius than bearing.
- Excess clearance during operation.
- Excess impact load.

Countermeasures

- Check fits. Finish shaft and sleeve to higher accuracy.
- Make shaft corner radius smaller than that of the bearing.
- Check fits and bearing clearance.
- Re-check load conditions.

Table 9.3 Symptoms and Countermeasures of Bearing Problems

(4) Indentation
Brinelling, indentation and pear skin appearance of bearing raceway and rolling element.

Causes

- Impact applied during mounting.
- Impact from dropped bearing.
- Contamination
- Load applied to bearing at rest in excess of static load rating.

Countermeasures

- Carefully handle the bearing.
- Clean shaft and housing.
- Improve the sealing.
- Re-check load conditions.



(5) Fretting
Occurs when a small relative motion is repeatedly caused in non-rotating bearing. Fretting surface wear produces red colored particles at fitting surface.

Causes

- Vibration applied to bearing at rest (e.g. during shipment).
- Oscillation with smaller amplitude.
- Minute clearance on fit surface.
- Slight sliding during operation as a result reduced interference under a load.

Countermeasures

- Fit the shaft and housing during shipment.
- Apply a preload. Use oil for lubrication.
- Increase the interference.
- Apply oil.

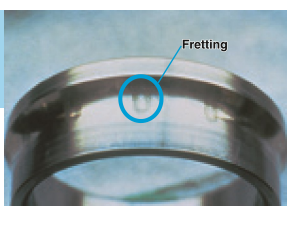

(6) Scoring
Metal to metal contact of bearing raceway, flange face, rolling element and retainer due to destruction of oil film.

Causes

- Incorrect lubrication.
- Contamination by foreign matter.
- Deflection or misalignment of shaft. Excessive axial load.
- Sharp speed increase at startup.

Countermeasures

- Review type and quantity of lubricant.
- Improve sealing and component cleaning.
- Correct mounting errors. Review load conditions.
- Change to smooth acceleration.

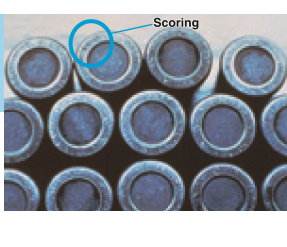

(7) Smearing
Metal to metal contact due to the destruction of oil film. Sliding motion between outer/inner ring and rolling element.

Causes

- Excess axial load.
- Misalignment of bearing.
- Poor lubrication.
- Intrusion and galling caused by foreign matter.
- High acceleration on start-up.

Countermeasures

- Correct mounting errors.
- Review the load condition.
- Select a proper lubricant, and feed it in proper quantity, and improve the sealing.
- Clean shaft and housing.
- Avoid sharp acceleration.



(8) Excessive Wear
Abnormal wear of flange face, rolling element and retainer.

Causes

- Foreign matter and corrosion acting as lapping agent.
- Insufficient or incorrect lubricant.

Countermeasures

- Improve sealing.
- Clean shaft and housing.
- Check lubricant for type and amount.



(9) Rusting, Corrosion
Rusting and corrosion of bearing ring and rolling element surface.

Causes

- Improper storage, cleaning.
- Improper washing oil.
- Poor rust prevention.
- Corrosive gas, liquid or water.
- Handling with unprotected hands.
- Chemical action of lubricant.

Countermeasures

- Improve storage and handling.
- Re-check washing oil.
- Review rust prevention.
- Improve sealing.
- Correct handling.
- Check lubricant.

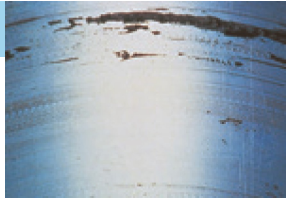



Table 9.3 Symptoms and Countermeasures of Bearing Problems

(10) Creep
Galling, wear, sliding and discoloration of fit face.

- | | |
|---|---|
| <p>■ Causes</p> <ul style="list-style-type: none"> • Insufficient interference. • Insufficient tightened sleeve. • Insufficient surface pressure due to low rigidity and inaccurate shaft and housing. | <p>■ Countermeasures</p> <ul style="list-style-type: none"> • Check fits. • Tighten sleeve. • Redesign for greater rigidity. |
|---|---|





Deep-groove Ball Bearings

Accuracy Page 52
 Internal clearance Page 64
 Dimensions of snap ring Page 45

Because of their versatility, Single-row, Deep-groove Ball Bearings are the most popular of all the ball bearing types. NACHI Deep-groove Ball Bearings are available in a wide range of series defined by the JIS (ISO) standard dimension plan and are also made to meet specialized dimension and configuration requirements. NACHI Deep-groove Ball Bearings are manufactured in both standard precision grade

(ISO Grade 0 -ABEC Grade 1) as well as in high-precision grades. Table 1 shows common, standard configurations of Single-row Deep-groove Ball Bearings. Table 2 next page shows a comparison of general characteristics of seal and shield designs for Single-row, Deep-groove Ball bearings.

Table 1. Standard Configuration of Single-row, Deep-groove Ball Bearings

Configuration	Design	Cross section
Open (no seals, shields)	Consists of inner and outer rings, balls, and cage.	 Open
Shield	One or two steel shields provide labyrinth clearance	 Z ZZ ZE ZZE
(1)Sealed or shielded Bearings	Non-contact Rubber Seal(2)	One or two non-contact rubber seals provide labyrinth clearance NK 2NK NKE 2NKE
	Contact Rubber Seal(2)	One or two contact rubber seals in contact with inner ring NSL 2NSL NSE 2NSE
Snap-ring Groove in Outer Ring	N : with snap-ring groove in outer ring. NR: with groove and snap ring in outer ring. (Use of snap ring allows easy mounting and simplified housing design.) Sealed or shielded bearings are also available, contact NACHI for more information.	 N NR

Notes: (1) One seal or shield type bearings may have a seal groove on the other side.
 Seals or shields for two seal or two shield bearings have the same marks as one seal or one shield bearings.
 (2) NKE seals are blue and NSE seals are brown

Table 2. Comparison of Seal and Shield Characteristics

Characteristics	Shield (Z, ZE)	Non-contact Rubber Seal (NK, NKE)	Contact Rubber Seal (MSL, NSE)
Friction torque	Low	Low	Higher than NK, NKE, Z and ZE
High speed	Excellent	Excellent	Good (There is some limitation)
Grease sealing	Good	Better than Z, ZE	Excellent at low speed ①The grease may leak from the bearing at high speeds and high temperature. ②The grease may leak in case of outer ring rotation.
Dust proof	Good	Better than Z, ZE	Excellent (Can be used in severe dust environments)
Water proof	unsuitable	unsuitable	Excellent
Recommended operation temperature range for standard filled grease	-25~120°C	-25~120°C	-25~120°C

● Load rating

The values for basic dynamic load rating (Cr) and basic static load rating (Cor) given in the dimension table are for inner rings, outer rings and ball bearings of bearing steel with normal heat treatment.

(4) When a bearing is mounted on a shaft (into a housing), force should only be applied to the side face of the inner (outer) ring.

(5) The sealed or shielded bearings should not be washed or heated before mounting.

(6) It should be noted that mounting errors such as misalignment of the bearing rings cause an appreciable increase in noise level.

(7) The bearings must always be subjected to a minimum load to prevent sliding movements occurring between the balls and the raceways.

● Attention

(1) Deep-groove Ball Bearings can sustain radial, axial or composite loads. However when excessive axial load is applied, please consult with NACHI.

(2) Because sealed or shielded bearings are designed for inner ring rotating applications, the filled grease may leak when they are used with a high speed outer ring rotating condition. In such a case, please contact NACHI.

(3) When bearings with contact rubber seals are used in a severe operating condition such as high speed or high temperature, the filled grease may leak. In such a case, a design change or another kind of grease is required.

Deep-groove Ball Bearings

Bore Diameter: 10~25mm

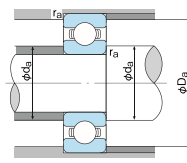
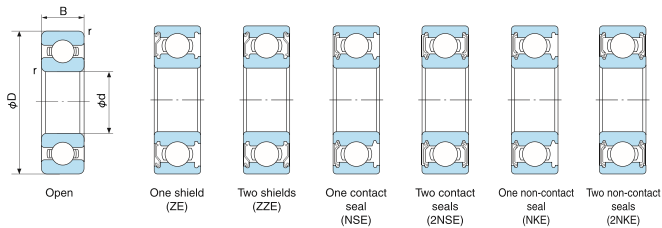

Dynamic equivalent radial load
Pr=XFr+YFa

Static equivalent radial load
Larger value of following to be used:
Por=0.6Fr+0.5Fa
Por=Fr

10Fa Cor	e	Fa Fr ≤ e		Fa Fr > e	
		X	Y	X	Y
0.172	0.19				2.30
0.345	0.22	1	0	0.56	1.99
0.689	0.26				1.71
1.03	0.28				1.55
1.38	0.30	1	0	0.56	1.45
2.07	0.34				1.31
3.45	0.38				1.15
5.17	0.42	1	0	0.56	1.04
6.89	0.44				1.00

Boundary dimensions (mm)				Bearing No.							Basic dynamic load rating Cr (N)	Basic static load rating Cor (N)	Factor fo	Limiting speed (min ⁻¹)			Abutment and fillet dimensions (mm)			Mass (kg)	Bearing No.	
d	D	B	r (min)	Open type	Shield type		Contact seal type		Non-contact seal type					Grease lubrication		Oil lubrication		da (min)	Da (max)			ra (max)
10	19	5	0.3	6800	6800ZE	6800ZZE	6800NSE	6800-2NSE	6800NKE	6800-2NKE	2120	985	14.2	37000	24000	38000	12	17	0.3	0.005	6800	
	22	6	0.3	6900	6900ZE	6900ZZE	6900NSE	6900-2NSE	6900NKE	6900-2NKE	2490	1130	14.0	33000	22000	36000	12	20	0.3	0.009	6900	
	26	8	0.3	6000	6000ZE	6000ZZE	6000NSE	6000-2NSE	6000NKE	6000-2NKE	4550	1970	12.4	30000	22000	36000	12	24	0.3	0.019	6000	
	30	9	0.6	6200	6200ZE	6200ZZE	6200NSE	6200-2NSE	6200NKE	6200-2NKE	5100	2390	13.2	25000	18000	30000	15	25	0.6	0.032	6200	
12	35	11	0.6	6300	6300ZE	6300ZZE	6300NSE	6300-2NSE	6300NKE	6300-2NKE	8100	3450	11.3	23000	17000	27000	15	30	0.6	0.053	6300	
	21	5	0.3	6801	6801ZE	6801ZZE	6801NSE	6801-2NSE	6801NKE	6801-2NKE	1920	1040	15.3	32000	20000	39000	14	19	0.3	0.006	6801	
	24	6	0.3	6901	6901ZE	6901ZZE	6901NSE	6901-2NSE	6901NKE	6901-2NKE	2700	1320	14.5	30000	20000	36000	14	22	0.3	0.011	6901	
	28	8	0.3	6001	6001ZE	6001ZZE	6001NSE	6001-2NSE	6001NKE	6001-2NKE	5100	2390	13.2	28000	18000	32000	14	26	0.3	0.023	6001	
	32	10	0.6	6201	6201ZE	6201ZZE	6201NSE	6201-2NSE	6201NKE	6201-2NKE	6800	3050	12.3	22000	17000	28000	17	27	0.6	0.037	6201	
15	37	12	1	6301	6301ZE	6301ZZE	6301NSE	6301-2NSE	6301NKE	6301-2NKE	9750	4250	11.2	20000	16000	24000	18	31	1.0	0.060	6301	
	24	5	0.3	6802	6802ZE	6802ZZE	6802NSE	6802-2NSE	6802NKE	6802-2NKE	2080	1260	15.8	28000	17000	34000	17	22	0.3	0.007	6802	
	28	7	0.3	6902	6902ZE	6902ZZE	6902NSE	6902-2NSE	6902NKE	6902-2NKE	4300	2250	14.3	26000	17000	31000	17	26	0.3	0.016	6902	
	32	8	0.3	16002	—	—	—	—	—	—	5600	2840	13.9	24000	—	28000	20	27	0.3	0.025	16002	
	32	9	0.3	6002	6002ZE	6002ZZE	6002NSE	6002-2NSE	6002NKE	6002-2NKE	5600	2840	13.9	24000	15000	28000	17	30	0.3	0.032	6002	
	35	11	0.6	6202	6202ZE	6202ZZE	6202NSE	6202-2NSE	6202NKE	6202-2NKE	7650	3700	13.1	20000	15000	24000	20	30	0.6	0.045	6202	
17	42	13	1	6302	6302ZE	6302ZZE	6302NSE	6302-2NSE	6302NKE	6302-2NKE	11400	5400	12.3	17000	13000	21000	21	36	1.0	0.082	6302	
	26	5	0.3	6803	6803ZE	6803ZZE	6803NSE	6803-2NSE	6803NKE	6803-2NKE	2630	1570	16.1	26000	15000	30000	19	24	0.3	0.008	6803	
	30	7	0.3	6903	6903ZE	6903ZZE	6903NSE	6903-2NSE	6903NKE	6903-2NKE	4600	2550	14.7	24000	15000	29000	19	28	0.3	0.018	6903	
	35	8	0.3	16003	—	—	—	—	—	—	6000	3250	14.3	22000	—	26000	22	30	0.3	0.032	16003	
	35	10	0.3	6003	6003ZE	6003ZZE	6003NSE	6003-2NSE	6003NKE	6003-2NKE	6000	3250	14.3	22000	14000	26000	19	33	0.3	0.039	6003	
20	40	12	0.6	6203	6203ZE	6203ZZE	6203NSE	6203-2NSE	6203NKE	6203-2NKE	9550	4800	13.1	18000	12000	21000	22	35	0.6	0.065	6203	
	47	14	1	6303	6303ZE	6303ZZE	6303NSE	6303-2NSE	6303NKE	6303-2NKE	13600	6550	12.3	16000	11000	19000	23	41	1.0	0.115	6303	
	32	7	0.3	6804	6804ZE	6804ZZE	6804NSE	6804-2NSE	6804NKE	6804-2NKE	4000	2640	15.5	22000	13000	26000	22	30	0.3	0.019	6804	
	37	9	0.3	6904	6904ZE	6904ZZE	6904NSE	6904-2NSE	6904NKE	6904-2NKE	6350	3700	14.8	19000	12000	23000	22	35	0.3	0.036	6904	
	42	8	0.3	16004	—	—	—	—	—	—	7900	4500	14.5	18000	—	21000	25	37	0.3	0.050	16004	
	42	12	0.6	6004	6004ZE	6004ZZE	6004NSE	6004-2NSE	6004NKE	6004-2NKE	9400	5000	13.9	18000	11000	21000	24	38	0.6	0.070	6004	
22	47	14	1	6204	6204ZE	6204ZZE	6204NSE	6204-2NSE	6204NKE	6204-2NKE	12800	6600	13.1	16000	11000	18000	26	41	1.0	0.106	6204	
	52	15	1.1	6304	6304ZE	6304ZZE	6304NSE	6304-2NSE	6304NKE	6304-2NKE	15900	7900	12.4	14000	10000	17000	27	45	1.1	0.144	6304	
	50	14	1	62/22	62/22ZE	62/22ZZE	62/22NSE	62/22-2NSE	62/22NKE	62/22-2NKE	13900	6950	13.1	14000	9700	17000	28	44	1.0	0.120	62/22	
	56	16	1.1	63/22	63/22ZE	63/22ZZE	63/22NSE	63/22-2NSE	63/22NKE	63/22-2NKE	18400	9250	12.4	13000	9500	16000	29	49	1.0	0.176	63/22	
25	37	7	0.3	6805	6805ZE	6805ZZE	6805NSE	6805-2NSE	6805NKE	6805-2NKE	4300	2940	16.0	18000	10000	22000	27	35	0.3	0.022	6805	
	42	9	0.3	6905	6905ZE	6905ZZE	6905NSE	6905-2NSE	6905NKE	6905-2NKE	7000	4500	15.3	16000	10000	20000	27	40	0.3	0.042	6905	
	47	8	0.3	16005	—	—	—	—	—	—	6950	4600	15.6	15000	—	18000	30	42	0.3	0.060	16005	
	47	12	0.6	6005	6005ZE	6005ZZE	6005NSE	6005-2NSE	6005NKE	6005-2NKE	10100	5850	14.5	15000	9500	18000	29	43	0.6	0.079	6005	
	52	15	1	6205	6205ZE	6205ZZE	6205NSE	6205-2NSE	6205NKE	6205-2NKE	14000	7900	13.9	13000	9000	16000	31	46	1.0	0.128	6205	
62	17	1.1	6305	6305ZE	6305ZZE	6305NSE	6305-2NSE	6305NKE	6305-2NKE	23600	12100	12.2	12000	8100	14000	32	55	1.0	0.232	6305		

Deep-groove Ball Bearings

Bore Diameter: 28~50mm

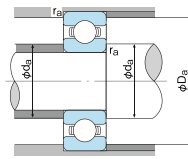
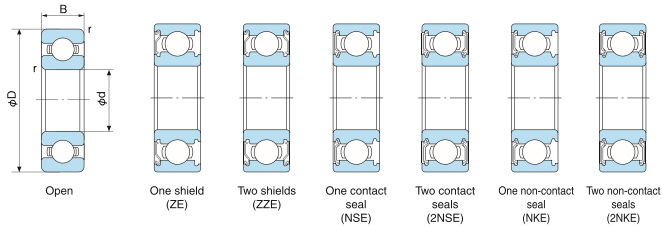

■ **Dynamic equivalent radial load**
 $P_r = X F_r + Y F_a$

■ **Static equivalent radial load**
 Larger value of following to be used:
 $P_{0r} = 0.6 F_r + 0.5 F_a$
 $P_{0r} = F_r$

$\frac{10 F_a}{F_r \text{ Cor}}$	e	$\frac{F_a}{F_r} \leq e$		$\frac{F_a}{F_r} > e$	
		X	Y	X	Y
0.172	0.19				2.30
0.345	0.22	1	0	0.56	1.99
0.689	0.26				1.71
1.03	0.28				1.55
1.38	0.30	1	0	0.56	1.45
2.07	0.34				1.31
3.45	0.38				1.15
5.17	0.42	1	0	0.56	1.04
6.89	0.44				1.00

Boundary dimensions (mm)				Bearing No.								Basic dynamic load rating Cr (N)	Basic static load rating Cor (N)	Factor f_0	Limiting speed (min ⁻¹)				Abutment and fillet dimensions (mm)			Mass (kg)	Bearing No.
d	D	B	r (min)	Open type		Shield type		Contact seal type		Non-contact seal type					Grease lubrication		Oil lubrication		da (min)	Da (max)	ra (max)		
Open type, ZE, ZZE, NKE, 2NKE		NSE, 2NSE		Open type, ZE																			
28	58	16	1	62/28	62/28ZE	62/28ZZE	62/28NSE	62/28-2NSE	62/28NKE	62/28-2NKE	17900	9750	13.1	12000	8200	14000	34	52	1.0	0.175	62/28		
	68	18	1.1	63/28	63/28ZE	63/28ZZE	63/28NSE	63/28-2NSE	63/28NKE	63/28-2NKE	26800	14000	12.4	11000	7500	13000	35	61	1.0	0.287	63/28		
	42	7	0.3	6806	6806ZE	6806ZZE	6806NSE	6806-2NSE	6806NKE	6806-2NKE	5350	3800	16.4	15000	9000	18000	32	40	0.3	0.026	6806		
30	47	9	0.3	6906	6906ZE	6906ZZE	6906NSE	6906-2NSE	6906NKE	6906-2NKE	7250	5000	15.8	14000	8500	17000	32	45	0.3	0.045	6906		
	55	9	0.3	16006							9950	6550	15.4	13000		15000	35	50	0.3	0.085	16006		
	55	13	1	6006	6006ZE	6006ZZE	6006NSE	6006-2NSE	6006NKE	6006-2NKE	13200	8300	14.8	13000	8000	15000	35	50	1.0	0.117	6006		
32	62	16	1	6206	6206ZE	6206ZZE	6206NSE	6206-2NSE	6206NKE	6206-2NKE	19500	11300	13.9	11000	7500	13000	36	56	1.0	0.199	6206		
	72	19	1.1	6306	6306ZE	6306ZZE	6306NSE	6306-2NSE	6306NKE	6306-2NKE	26700	15000	13.2	10000	6700	12000	37	65	1.0	0.346	6306		
	65	17	1	62/32	62/32ZE	62/32ZZE	62/32NSE	62/32-2NSE	62/32NKE	62/32-2NKE	22400	13100	13.6	11000	7100	12000	38	59	1.0	0.230	62/32		
35	75	20	1.1	63/32	63/32ZE	63/32ZZE	63/32NSE	63/32-2NSE	63/32NKE	63/32-2NKE	30000	16200	12.7	9500	6500	11000	39	68	1.0	0.382	63/32		
	47	7	0.3	6807	6807ZE	6807ZZE	6807NSE	6807-2NSE	6807NKE	6807-2NKE	4750	3800	16.4	14000	7600	16000	37	45	0.3	0.029	6807		
	55	10	0.6	6907	6907ZE	6907ZZE	6907NSE	6907-2NSE	6907NKE	6907-2NKE	10400	7150	15.6	12000	7500	15000	39	51	0.6	0.073	6907		
40	62	9	0.3	16007							11700	8150	15.6	12000		14000	40	57	0.6	0.110	16007		
	62	14	1	6007	6007ZE	6007ZZE	6007NSE	6007-2NSE	6007NKE	6007-2NKE	16000	10300	14.8	12000	6800	14000	40	57	1.0	0.156	6007		
	72	17	1.1	6207	6207ZE	6207ZZE	6207NSE	6207-2NSE	6207NKE	6207-2NKE	25700	15300	13.8	9800	6300	11000	42	65	1.0	0.288	6207		
45	80	21	1.5	6307	6307ZE	6307ZZE	6307NSE	6307-2NSE	6307NKE	6307-2NKE	33500	19200	13.2	8800	6000	10000	44	71	1.5	0.457	6307		
	52	7	0.3	6808	6808ZE	6808ZZE	6808NSE	6808-2NSE	6808NKE	6808-2NKE	5950	4900	16.2	12000	6700	14000	42	50	0.3	0.033	6808		
	68	12	0.6	6908	6908ZE	6908ZZE	6908NSE	6908-2NSE	6908NKE	6908-2NKE	13700	9950	15.8	11000	6300	13000	44	58	0.6	0.108	6908		
50	68	9	0.3	16008							11100	8550	16.1	10000		12000	45	63	0.3	0.125	16008		
	68	15	1	6008	6008ZE	6008ZZE	6008NSE	6008-2NSE	6008NKE	6008-2NKE	16800	11500	15.3	10000	6100	12000	45	63	1.0	0.194	6008		
	80	18	1.1	6208	6208ZE	6208ZZE	6208NSE	6208-2NSE	6208NKE	6208-2NKE	29100	17900	14.0	8700	5600	10000	47	73	1.0	0.366	6208		
45	90	23	1.5	6308	6308ZE	6308ZZE	6308NSE	6308-2NSE	6308NKE	6308-2NKE	40500	24100	13.2	7800	5300	9200	49	81	1.5	0.633	6308		
	58	7	0.3	6809	6809ZE	6809ZZE	6809NSE	6809-2NSE	6809NKE	6809-2NKE	5350	4900	16.1	11000	6000	13000	47	56	0.3	0.040	6809		
	68	12	0.6	6909	6909ZE	6909ZZE	6909NSE	6909-2NSE	6909NKE	6909-2NKE	14100	10900	16.1	10000	5600	12000	49	64	0.6	0.122	6909		
50	75	10	0.6	16009							12900	10500	16.2	9200		11000	52	68	0.6	0.170	16009		
	75	16	1	6009	6009ZE	6009ZZE	6009NSE	6009-2NSE	6009NKE	6009-2NKE	20900	15200	15.3	9200	5400	11000	50	70	1.0	0.246	6009		
	85	19	1.1	6209	6209ZE	6209ZZE	6209NSE	6209-2NSE	6209NKE	6209-2NKE	32500	20500	14.1	7800	5300	9300	52	78	1.0	0.407	6209		
50	100	25	1.5	6309	6309ZE	6309ZZE	6309NSE	6309-2NSE	6309NKE	6309-2NKE	53000	32000	13.1	7000	4800	8200	54	91	1.5	0.833	6309		
	65	7	0.3	6810	6810ZE	6810ZZE	6810NSE	6810-2NSE	6810NKE	6810-2NKE	6400	5800	16.1	10000	5300	12000	52	63	0.3	0.052	6810		
	72	12	0.6	6910	6910ZE	6910ZZE	6910NSE	6910-2NSE	6910NKE	6910-2NKE	14500	11700	16.1	9500	5300	11000	54	68	0.6	0.125	6910		
50	80	10	0.6	16010							16100	13100	16.1	8500		10000	57	73	0.6	0.180	16010		
	80	16	1	6010	6010ZE	6010ZZE	6010NSE	6010-2NSE	6010NKE	6010-2NKE	21800	16600	15.6	8500	5000	10000	55	75	1.0	0.264	6010		
	90	20	1.1	6210	6210ZE	6210ZZE	6210NSE	6210-2NSE	6210NKE	6210-2NKE	35000	23200	14.4	7100	4800	8600	57	83	1.0	0.463	6210		
50	110	27	2	6310	6310ZE	6310ZZE	6310NSE	6310-2NSE	6310NKE	6310-2NKE	62000	38000	13.1	6400	4300	7500	60	100	2.0	1.07	6310		

Deep-groove Ball Bearings

Bore Diameter: 55~80mm

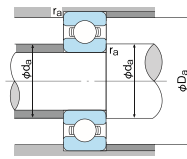
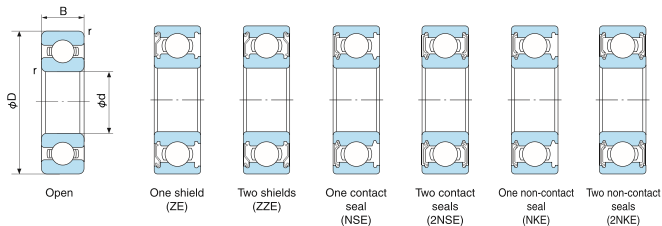

Dynamic equivalent radial load
 $P_r = X F_r + Y F_a$

Static equivalent radial load
 Larger value of following to be used:
 $P_{0r} = 0.6 F_r + 0.5 F_a$
 $P_{0r} = F_r$

$\frac{10 F_a}{F_r \text{ Cor}}$	e	$\frac{F_a}{F_r} \leq e$	$\frac{F_a}{F_r} > e$
		X	Y
0.172	0.19		2.30
0.345	0.22	1	1.99
0.689	0.26		1.71
1.03	0.28		1.55
1.38	0.30	1	1.45
2.07	0.34		1.31
3.45	0.38		1.15
5.17	0.42	1	1.04
6.89	0.44		1.00

Boundary dimensions (mm)				Bearing No.							1N=0.102kgf			Limiting speed (min ⁻¹)				Abutment and fillet dimensions (mm)			Mass (kg)	Bearing No.
d	D	B	r (min)	Open type	Shield type		Contact seal type		Non-contact seal type		Basic dynamic load rating Cr (N)	Basic static load rating Cor (N)	Factor f ₀	Grease lubrication		Oil lubrication	d _a (min)	D _a (max)	r _a (max)			
														Open type, ZE, ZZE, NKE, 2NKE	NSE, 2NSE	Open type, ZE						
55	72	9	0.3	6811	6811Z	6811ZZ	—	—	—	—	8800	8100	16.2	8700	—	10000	57	70	0.3	0.083	6811	
	80	13	1	6911	6911Z	6911ZZ	—	—	—	—	16000	13200	16.2	8200	—	9600	60	75	1.0	0.177	6911	
	90	11	0.6	16011	—	—	—	—	—	—	15200	13500	16.5	7700	—	9000	62	83	0.6	0.260	16011	
	90	18	1.1	6011	6011ZE	6011ZZE	6011NSE	6011-2NSE	6011NKE	6011-2NKE	28300	21300	15.4	7700	4500	9000	61	84	1.0	0.384	6011	
	100	21	1.5	6211	6211ZE	6211ZZE	6211NSE	6211-2NSE	6211NKE	6211-2NKE	43500	29300	14.4	6400	4300	7700	64	91	1.5	0.607	6211	
	120	29	2	6311	6311ZE	6311ZZE	6311NSE	6311-2NSE	6311NKE	6311-2NKE	71500	44500	13.1	5800	4000	6800	65	110	2.0	1.37	6311	
60	78	10	0.3	6812	6812Z	6812ZZ	—	—	—	—	11500	10600	16.3	8000	—	9500	62	76	0.3	0.106	6812	
	85	13	1	6912	6912Z	6912ZZ	—	—	—	—	15200	13500	16.5	7600	—	8500	65	80	1.0	0.191	6912	
	95	11	0.6	16012	—	—	—	—	—	—	16200	14300	16.5	7100	—	8000	67	88	0.6	0.280	16012	
	95	18	1.1	6012	6012ZE	6012ZZE	6012NSE	6012-2NSE	6012NKE	6012-2NKE	29400	23200	15.5	7100	4100	8500	66	89	1.0	0.418	6012	
	110	22	1.5	6212	6212ZE	6212ZZE	6212NSE	6212-2NSE	6212NKE	6212-2NKE	52500	36000	14.3	6000	3800	7100	69	101	1.5	0.783	6212	
	130	31	2.1	6312	6312ZE	6312ZZE	6312NSE	6312-2NSE	6312NKE	6312-2NKE	82000	52000	13.2	5400	3600	6300	72	118	2.0	1.70	6312	
65	85	10	0.6	6813	6813Z	6813ZZ	—	—	—	—	11900	11500	16.2	7500	—	8700	69	81	0.6	0.125	6813	
	90	13	1	6913	6913Z	6913ZZ	—	—	—	—	17400	16000	16.5	7100	—	8500	70	85	1.0	0.200	6913	
	100	11	0.6	16013	—	—	—	—	—	—	20500	18600	16.4	6700	—	8000	72	93	0.6	0.300	16013	
	100	18	1.1	6013	6013ZE	6013ZZE	6013NSE	6013-2NSE	6013NKE	6013-2NKE	30500	25200	15.7	6700	4000	8000	71	94	1.0	0.438	6013	
	120	23	1.5	6213	6213ZE	6213ZZE	6213NSE	6213-2NSE	6213NKE	6213-2NKE	57000	40000	14.4	5500	3600	6500	74	111	1.5	0.990	6213	
	140	33	2.1	6313	6313ZE	6313ZZE	6313NSE	6313-2NSE	6313NKE	6313-2NKE	92500	59500	13.2	4900	3400	6000	77	128	2.0	2.08	6313	
70	90	10	0.6	6814	6814Z	6814ZZ	—	—	—	—	12100	11900	16.1	7000	—	8100	74	86	0.6	0.135	6814	
	100	16	1	6914	6914Z	6914ZZ	—	—	—	—	23700	21100	16.3	6500	—	7700	75	95	1.0	0.327	6914	
	110	13	0.6	16014	—	—	—	—	—	—	26800	23600	16.2	6100	—	7100	77	103	0.6	0.433	16014	
	110	20	1.1	6014	6014ZE	6014ZZE	6014NSE	6014-2NSE	6014NKE	6014-2NKE	38000	31000	15.6	6100	3600	7100	76	104	1.0	0.607	6014	
	125	24	1.5	6214	6214ZE	6214ZZE	6214NSE	6214-2NSE	6214NKE	6214-2NKE	62000	44000	14.4	5100	3400	6300	79	116	1.5	1.07	6214	
	150	35	2.1	6314	6314ZE	6314ZZE	6314NSE	6314-2NSE	6314NKE	6314-2NKE	104000	68000	13.2	4600	3200	5400	82	138	2.0	2.52	6314	
75	95	10	0.6	6815	6815Z	6815ZZ	—	—	—	—	12500	12800	16.0	6500	—	7600	79	91	0.6	0.145	6815	
	105	16	1	6915	6915Z	6915ZZ	—	—	—	—	20800	19700	16.5	6200	—	7200	80	100	1.0	0.345	6915	
	115	13	0.6	16015	—	—	—	—	—	—	27600	25300	16.4	5700	—	6700	82	108	0.6	0.457	16015	
	115	20	1.1	6015	6015ZE	6015ZZE	6015NSE	6015-2NSE	6015NKE	6015-2NKE	39500	33500	15.7	5700	3400	6700	81	109	1.0	0.645	6015	
	130	25	1.5	6215	6215ZE	6215ZZE	6215NSE	6215-2NSE	6215NKE	6215-2NKE	66000	49500	14.7	4800	3200	5600	84	121	1.5	1.18	6215	
	160	37	2.1	6315	6315ZE	6315ZZE	6315NSE	6315-2NSE	6315NKE	6315-2NKE	113000	77000	13.2	4300	2900	5000	87	148	2.0	3.02	6315	
80	100	10	0.6	6816	6816Z	6816ZZ	—	—	—	—	12700	13300	15.9	6000	—	7100	84	96	0.6	0.155	6816	
	110	16	1	6916	6916Z	6916ZZ	—	—	—	—	27600	25300	16.4	5700	—	6700	85	105	1.0	0.363	6916	
	125	14	0.6	16016	—	—	—	—	—	—	32000	29600	16.4	5300	—	6300	87	118	0.6	0.597	16016	
	125	22	1.1	6016	6016Z	6016ZZ	—	—	—	—	47500	39500	15.6	5300	—	6300	86	119	1.0	0.855	6016	
	140	26	2	6216	6216Z	6216ZZ	6216NSL	6216-2NSL	6216NK	6216-2NK	72500	53000	14.6	4500	3000	5300	90	130	2.0	1.40	6216	
	170	39	2.1	6316	6316Z	6316ZZ	6316NSL	6316-2NSL	6316NK	6316-2NK	123000	86500	13.2	4000	2800	4800	92	158	2.0	3.59	6316	

Deep-groove Ball Bearings

Bore Diameter: 85~110mm

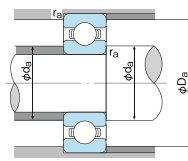
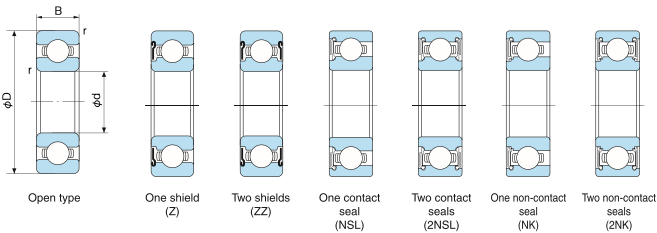

Dynamic equivalent radial load
 $P_r = X F_r + Y F_a$

Static equivalent radial load
 Larger value of following to be used:
 $P_{0r} = 0.6 F_r + 0.5 F_a$
 $P_{0r} = F_r$

f ₀ F _a Cor	e	F _a /F _r ≤ e		F _a /F _r > e	
		X	Y	X	Y
0.172	0.19				2.30
0.345	0.22	1	0	0.56	1.99
0.689	0.26				1.71
1.03	0.28				1.55
1.38	0.30	1	0	0.56	1.45
2.07	0.34				1.31
3.45	0.38				1.15
5.17	0.42	1	0	0.56	1.04
6.89	0.44				1.00

Boundary dimensions (mm)				Bearing No.							1N=0.102kgf				Limiting speed (min ⁻¹)				Abutment and fillet dimensions (mm)			Mass (kg)	Bearing No.
d	D	B	r (min)	Open type	Shield type		Contact seal type		Non-contact seal type		Basic dynamic load rating Cr (N)	Basic static load rating Cor (N)	Factor f ₀	Grease lubrication		Oil lubrication		d _a (min)	D _a (max)	r _a (max)			
										Open type, Z, ZZ, NK, 2NK				NSL, 2NSL	Open type, Z								
85	110	13	1	6817	6817Z	6817ZZ	—	—	—	—	18700	19000	16.2	5700	—	6700	90	105	1.0	0.265	6817		
	120	18	1.1	6917	6917Z	6917ZZ	—	—	—	—	32000	29600	16.4	5400	—	6300	91	113	1.0	0.517	6917		
	130	14	0.6	16017	—	—	—	—	—	—	31500	29800	16.4	5000	—	6000	92	123	0.6	0.626	16017		
	130	22	1.1	6017	6017Z	6017ZZ	—	—	—	—	49500	43000	15.7	5000	—	6000	91	124	1.1	0.895	6017		
	150	28	2	6217	6217Z	6217ZZ	6217NSL	6217-2NSL	6217NK	6217-2NK	84000	62000	14.5	4300	2800	5000	95	140	2.0	1.79	6217		
	180	41	3	6317	6317Z	6317ZZ	6317NSL	6317-2NSL	6317NK	6317-2NK	133000	96500	13.3	3800	2600	4500	99	166	2.5	4.23	6317		
90	115	13	1	6818	6818Z	6818ZZ	—	—	—	—	19000	19700	16.1	5400	—	6300	95	110	1.0	0.280	6818		
	125	18	1.1	6918	6918Z	6918ZZ	—	—	—	—	33000	31500	16.4	5100	—	6000	96	119	1.0	0.540	6918		
	140	16	1	16018	—	—	—	—	—	—	41500	39500	16.3	4800	—	5600	99	131	1.0	0.848	16018		
	140	24	1.5	6018	6018Z	6018ZZ	—	—	—	—	58000	49500	15.6	4800	—	5600	97	133	1.5	1.17	6018		
	160	30	2	6218	6218Z	6218ZZ	6218NSL	6218-2NSL	6218NK	6218-2NK	96000	71500	14.5	4000	2600	4800	100	150	2.0	2.15	6218		
	190	43	3	6318	6318Z	6318ZZ	6318NSL	6318-2NSL	6318NK	6318-2NK	143000	107000	13.3	3600	2400	4300	104	176	2.5	4.91	6318		
95	120	13	1	6819	6819Z	6819ZZ	—	—	—	—	19300	20500	16.0	5000	—	6000	100	115	1.0	0.298	6819		
	130	18	1.1	6919	6919Z	6919ZZ	—	—	—	—	33500	33500	16.5	4800	—	5700	101	124	1.0	0.567	6919		
	145	16	1	16019	—	—	—	—	—	—	41000	39500	16.4	4600	—	5300	104	136	1.0	0.885	16019		
	145	24	1.5	6019	6019Z	6019ZZ	—	—	—	—	60500	54000	15.8	4500	—	5300	102	138	1.5	1.22	6019		
	170	32	2.1	6219	6219Z	6219ZZ	6219NSL	6219-2NSL	6219NK	6219-2NK	109000	81500	14.4	3800	2600	4500	107	158	2.0	2.62	6219		
	200	45	3	6319	6319Z	6319ZZ	6319NSL	6319-2NSL	6319NK	6319-2NK	153000	118000	13.3	3300	2400	3900	109	186	2.5	5.67	6319		
100	125	13	1	6820	6820Z	6820ZZ	—	—	—	—	19600	21200	16.0	4800	—	5600	105	120	1.0	0.311	6820		
	140	20	1.1	6920	6920Z	6920ZZ	—	—	—	—	42500	36500	16.5	4500	—	5300	106	134	1.0	0.771	6920		
	150	16	1	16020	—	—	—	—	—	—	37500	39500	16.4	4300	—	5300	109	141	1.0	0.910	16020		
	150	24	1.5	6020	6020Z	6020ZZ	—	—	—	—	60000	54000	15.9	4300	—	5300	107	143	1.5	1.26	6020		
	180	34	2.1	6220	6220Z	6220ZZ	6220NSL	6220-2NSL	6220NK	6220-2NK	122000	93000	14.4	3600	2400	4300	112	168	2.0	3.14	6220		
	215	47	3	6320	6320Z	6320ZZ	6320NSL	6320-2NSL	6320NK	6320-2NK	173000	141000	13.2	3200	2200	3700	114	201	2.5	7.00	6320		
105	130	13	1	6821	—	—	—	—	—	—	19900	21900	15.9	4800	—	5600	110	125	1.0	0.325	6821		
	145	20	1.1	6921	—	—	—	—	—	—	42500	42000	16.4	4300	—	5300	111	139	1.0	0.793	6921		
	160	18	1	16021	—	—	—	—	—	—	37500	50500	16.4	4000	—	4800	114	151	1.0	1.20	16021		
	160	26	2	6021	6021Z	6021ZZ	—	—	—	—	72500	65500	15.8	4000	—	4800	113	152	2.0	1.60	6021		
	190	36	2.1	6221	6221Z	6221ZZ	—	—	—	—	133000	104000	14.3	3400	—	4000	117	178	2.0	3.76	6221		
	225	49	3	6321	6321Z	6321ZZ	—	—	—	—	184000	153000	13.2	3000	—	3600	119	211	2.5	8.05	6321		
110	140	16	1	6822	—	—	—	—	—	—	27300	29400	16.9	4300	—	5300	115	135	1.0	0.510	6822		
	150	20	1.1	6922	—	—	—	—	—	—	38000	38500	16.4	4300	—	5000	116	144	1.0	0.830	6922		
	170	19	1	16022	—	—	—	—	—	—	44000	45000	16.5	3800	—	4500	119	161	1.0	1.46	16022		
	170	28	2	6022	6022Z	6022ZZ	—	—	—	—	84500	73000	15.5	3800	—	4500	118	162	2.0	1.97	6022		
	200	38	2.1	6222	6222Z	6222ZZ	—	—	—	—	144000	117000	14.3	3200	—	3800	122	188	2.0	4.36	6222		
	240	50	3	6322	6322Z	6322ZZ	—	—	—	—	205000	179000	13.1	2900	—	3400	124	226	2.5	9.54	6322		

Deep-groove Ball Bearings

Bore Diameter: 120~170mm

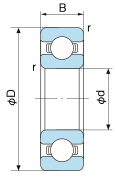

Open type

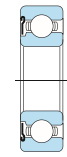

One shield (Z)



Two shields (ZZ)

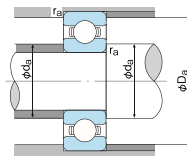

■ **Dynamic equivalent radial load**
 $P_r = X F_r + Y F_a$

■ **Static equivalent radial load**
 Larger value of following to be used:
 $P_{or} = 0.6 F_r + 0.5 F_a$
 $P_{or} = F_r$

$\frac{10 F_a}{F_r \text{ Cor}}$	e	$\frac{F_a}{F_r} \leq e$		$\frac{F_a}{F_r} > e$	
		X	Y	X	Y
0.172	0.19				2.30
0.345	0.22	1	0	0.56	1.99
0.689	0.26				1.71
	1.03	0.28			1.55
1.38	0.30	1	0	0.56	1.45
2.07	0.34				1.31
3.45	0.38				1.15
5.17	0.42	1	0	0.56	1.04
6.89	0.44				1.00

Boundary dimensions (mm)				Bearing No.						Basic dynamic load rating Cr (N)	Basic static load rating Cor (N)	Factor f_0	Limiting speed (min ⁻¹)			Abutment and fillet dimensions (mm)			Mass (kg)	Bearing No.	
d	D	B	r (min)	Open type	Shield type	Contact seal type	Non-contact seal type	Grease lubrication	Oil lubrication				d_a (min)	D_a (max)	r_a (max)						
								Open type, Z, ZZ	NSL, 2NSL				Open type, Z								
120	150	16	1	6824	—	—	—	—	—	—	28300	31500	16.0	4000	—	4800	125	145	1.0	0.549	6824
	165	22	1.1	6924	—	—	—	—	—	—	53000	54000	16.5	3800	—	4600	126	159	1.0	1.13	6924
	180	19	1	16024	—	—	—	—	—	—	48000	50000	16.4	3600	—	4300	129	171	1.0	1.80	16024
	180	28	2	6024	6024Z	6024ZZ	—	—	—	—	88000	79500	15.7	3600	—	4300	128	172	2.0	2.67	6024
	215	40	2.1	6224	6224Z	6224ZZ	—	—	—	—	145000	118000	14.4	2900	—	3400	132	203	2.0	5.15	6224
	260	55	3	6324	6324Z	6324ZZ	—	—	—	—	207000	185000	13.6	2600	—	3100	134	246	2.5	14.6	6324
130	165	18	1.1	6826	—	—	—	—	—	—	37000	41000	16.1	3700	—	4400	136	158	1.0	0.790	6826
	180	24	1.5	6926	—	—	—	—	—	—	65000	67000	16.4	3500	—	4200	137	173	1.5	1.78	6926
	200	22	1.1	16026	—	—	—	—	—	—	55000	59500	16.3	3200	—	3800	144	186	1.0	2.69	16026
	200	33	2	6026	6026Z	6026ZZ	—	—	—	—	106000	101000	15.7	3200	—	3800	138	192	2.0	3.92	6026
	230	40	3	6226	6226Z	6226ZZ	—	—	—	—	167000	146000	14.5	2700	—	3200	144	216	2.5	5.82	6226
	280	58	4	6326	6326Z	6326ZZ	—	—	—	—	229000	214000	13.6	2400	—	2800	148	262	3.0	18.2	6326
140	175	18	1.1	6828	—	—	—	—	—	—	38000	44500	16.0	3400	—	4000	146	169	1.0	0.840	6828
	190	24	1.5	6928	—	—	—	—	—	—	66500	71000	16.5	3200	—	3800	147	183	1.5	1.90	6928
	210	22	1.1	16028	—	—	—	—	—	—	56000	62000	16.2	3000	—	3500	154	196	1.0	2.86	16028
	210	33	2	6028	6028Z	6028ZZ	—	—	—	—	110000	109000	15.9	3000	—	3600	148	202	2.0	4.15	6028
	250	42	3	6228	6228Z	6228ZZ	—	—	—	—	166000	150000	14.8	2500	—	2900	154	236	2.5	7.47	6228
	300	62	4	6328	6328Z	6328ZZ	—	—	—	—	253000	246000	13.6	2200	—	2600	158	282	3.0	21.8	6328
150	190	20	1.1	6830	—	—	—	—	—	—	47500	54500	16.1	3200	—	3800	156	184	1.0	1.20	6830
	210	28	2	6930	—	—	—	—	—	—	85500	87000	16.4	3000	—	3500	158	202	2.0	2.64	6930
	225	24	1.1	16030	—	—	—	—	—	—	76500	82500	16.5	2800	—	3200	164	211	1.0	3.58	16030
	225	35	2.1	6030	6030Z	6030ZZ	—	—	—	—	126000	126000	15.9	2800	—	3200	159	216	2.0	4.48	6030
	270	45	3	6230	6230Z	6230ZZ	—	—	—	—	176000	168000	15.2	2300	—	2700	164	256	2.5	9.41	6230
	320	65	4	6330	—	—	—	—	—	—	274000	284000	13.9	2100	—	2400	168	302	3.0	26.2	6330
160	200	20	1.1	6832	—	—	—	—	—	—	48500	56500	16.0	2900	—	3400	166	194	1.0	1.30	6832
	220	28	2	6932	—	—	—	—	—	—	87500	95500	16.5	2800	—	3300	168	212	2.0	3.01	6932
	240	38	2.1	6032	—	—	—	—	—	—	137000	135000	15.9	2600	—	3000	169	231	2.0	5.89	6032
	290	48	3	6232	6232Z	6232ZZ	—	—	—	—	185000	186000	15.4	2100	—	2500	174	276	2.5	14.3	6232
	340	68	4	6332	—	—	—	—	—	—	278000	287000	13.9	1900	—	2300	178	322	3.0	28.6	6332
	170	215	22	1.1	6834	—	—	—	—	—	—	60000	70500	16.1	2700	—	3200	177	208	1.0	1.85
230		28	2	6934	—	—	—	—	—	—	86000	95000	16.4	2600	—	3100	178	222	2.0	3.17	6934
260		42	2.1	6034	—	—	—	—	—	—	161000	160000	15.7	2400	—	2800	179	251	2.0	7.92	6034
310		52	4	6234	—	—	—	—	—	—	212000	224000	15.3	2000	—	2400	188	292	3.0	17.5	6234
360		72	4	6334	—	—	—	—	—	—	325000	355000	13.6	1800	—	2100	188	342	3.0	34.0	6334

Deep-groove Ball Bearings

Bore Diameter: 180~280mm

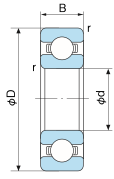

Open type



Open type
(Machined cage)

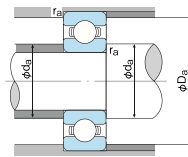

Dynamic equivalent radial load
 $P_r = XFr + YFa$

Static equivalent radial load
Larger value of following to be used:
 $P_{or} = 0.6Fr + 0.5Fa$
 $P_{or} = Fr$

$\frac{f_0 F_a}{C_{or}}$	e	$\frac{F_a}{Fr} \leq e$		$\frac{F_a}{Fr} > e$	
		X	Y	X	Y
0.172	0.19				2.30
0.345	0.22	1	0	0.56	1.99
0.689	0.26				1.71
1.03	0.28				1.55
1.38	0.30	1	0	0.56	1.45
2.07	0.34				1.31
3.45	0.38				1.15
5.17	0.42	1	0	0.56	1.04
6.89	0.44				1.00

Boundary dimensions (mm)				Bearing No.						Basic dynamic load rating Cr (N)	Basic static load rating Cor (N)	Factor f_0	Limiting speed (min ⁻¹)			Abutment and fillet dimensions (mm)			Mass (kg)	Bearing No.	
d	D	B	r (min)	Open type	Shield type	Contact seal type	Non-contact seal type	Grease lubrication Open type	NSL, 2NSL				Oil lubrication Open type	d_a (min)	D_a (max)	r_a (max)					
180	225	22	1.1	6836	-	-	-	-	-	-	60500	73000	16.0	2600	-	3000	187	218	1.0	2.02	6836
	250	33	2	6936	-	-	-	-	-	-	106000	117000	16.5	2400	-	2900	188	242	2.0	4.68	6936
	280	46	2.1	6036	-	-	-	-	-	-	174000	180000	15.8	2300	-	2700	189	271	2.0	10.3	6036
	320	52	4	6236	-	-	-	-	-	-	227000	242000	15.1	1900	-	2200	198	302	3.0	18.3	6236
	380	75	4	6336	-	-	-	-	-	-	325000	360000	13.9	1700	-	2000	198	362	3.0	41.9	6336
190	240	24	1.5	6838	-	-	-	-	-	-	73000	88000	16.1	2400	-	2900	198	232	1.5	2.60	6838
	260	33	2	6938	-	-	-	-	-	-	108000	123000	16.4	2300	-	2700	198	252	2.0	4.90	6938
	290	46	2.1	6038	-	-	-	-	-	-	188000	200000	15.7	2100	-	2500	199	281	2.0	10.8	6038
	340	55	4	6238	-	-	-	-	-	-	255000	282000	15.1	1800	-	2100	208	322	3.0	23.0	6238
	400	78	5	6338	-	-	-	-	-	-	355000	415000	14.1	1600	-	1900	212	378	4.0	48.2	6338
200	250	24	1.5	6840	-	-	-	-	-	-	74000	91000	15.9	2300	-	2700	208	242	1.5	2.70	6840
	280	38	2.1	6940	-	-	-	-	-	-	130000	146000	16.5	2200	-	2600	209	271	2.0	6.88	6940
	310	51	2.1	6040	-	-	-	-	-	-	202000	222000	15.8	2000	-	2400	209	301	2.0	13.9	6040
	360	58	4	6240	-	-	-	-	-	-	268000	310000	15.2	1700	-	2000	218	342	3.0	28.2	6240
	420	80	5	6340	-	-	-	-	-	-	380000	445000	13.9	1500	-	1800	222	398	4.0	54.6	6340
220	270	24	1.5	6844	-	-	-	-	-	-	76500	98000	15.9	2100	-	2400	228	262	1.5	2.98	6844
	300	38	2.1	6944	-	-	-	-	-	-	132000	154000	16.4	2000	-	2300	229	291	2.0	7.45	6944
	340	56	3	6044	-	-	-	-	-	-	214000	248000	15.9	1800	-	2200	230	330	2.5	18.4	6044
	400	65	4	6244	-	-	-	-	-	-	310000	375000	15.1	1500	-	1800	238	382	3.0	37.0	6244
	300	28	2	6848	-	-	-	-	-	-	98500	127000	15.9	1900	-	2200	250	291	2.0	4.60	6848
240	320	38	2.1	6948	-	-	-	-	-	-	154000	186000	16.3	1800	-	2100	249	311	2.0	8.02	6948
	360	56	3	6048	-	-	-	-	-	-	222000	268000	16.1	1700	-	2000	250	350	2.5	19.6	6048
	440	72	4	6248	-	-	-	-	-	-	340000	430000	15.2	1200	-	1500	258	322	3.0	49.9	6248
	320	28	2	6852	-	-	-	-	-	-	101000	136000	15.8	1700	-	2000	269	311	2.0	4.95	6852
260	360	46	2.1	6952	-	-	-	-	-	-	204000	254000	16.4	1600	-	1900	269	351	2.0	13.4	6952
	400	65	4	6052	-	-	-	-	-	-	252000	320000	16.1	1500	-	1800	272	388	3.0	29.3	6052
	480	80	5	6252	-	-	-	-	-	-	400000	540000	15.1	1100	-	1400	282	458	4.0	67.5	6252
	350	33	2	6856	-	-	-	-	-	-	133000	177000	16.1	1600	-	1900	290	341	2.0	7.35	6856
280	380	46	2.1	6956	-	-	-	-	-	-	209000	270000	16.3	1500	-	1800	289	371	2.0	14.3	6956
	420	65	4	6056	-	-	-	-	-	-	286000	350000	16.1	1400	-	1600	293	405	3.0	31.0	6056
	500	80	5	6256	-	-	-	-	-	-	400000	550000	15.3	1000	-	1300	302	478	4.0	71.0	6256

Deep-groove Ball Bearings

Bore Diameter: 300~320mm

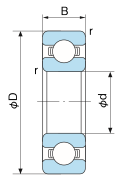

Open type



Open type
(Machined cage)

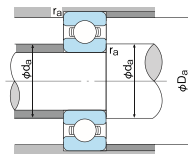

■ Dynamic equivalent radial load
Pr=XFr+YFa

■ Static equivalent radial load
Larger value of following to be used:
Por=0.6Fr+0.5Fa
Por=Fr

f ₀ Fa Cor	e	-Fa Fr ≤ e		-Fa Fr > e	
		X	Y	X	Y
0.172	0.19				2.30
0.345	0.22	1	0	0.56	1.99
0.689	0.26				1.71
1.03	0.28				1.55
1.38	0.30	1	0	0.56	1.45
2.07	0.34				1.31
3.45	0.38				1.15
5.17	0.42	1	0	0.56	1.04
6.89	0.44				1.00

Boundary dimensions (mm)				Bearing No.						Basic dynamic load rating Cr (N)	Basic static load rating Cor (N)	Factor f ₀	Limiting speed (min ⁻¹)			Abutment and fillet dimensions (mm)			Mass (kg)	Bearing No.		
d	D	B	r (min)	Open type	Shield type		Contact seal type		Non-contact seal type				Grease lubrication		Oil lubrication		d _a (min)	D _a (max)			r _a (max)	
															Open type	NSL, 2NSL	Open type					
300	380	38	2.1	6860	-	-	-	-	-	-	166000	219000	16.0	1500	-	1700	311	369	2.0	10.4	6860	
	420	56	3	6960	-	-	-	-	-	-	269000	370000	16.5	1400	-	1600	311	409	2.5	22.8	6960	
	460	74	4	6060	-	-	-	-	-	-	355000	490000	15.0	1300	-	1500	313	447	3.0	43.8	6060	
	540	85	5	6260	-	-	-	-	-	-	465000	670000	15.2	950	-	1200	322	518	4.0	88.6	6260	
320	400	38	2.1	6864	-	-	-	-	-	-	164000	218000	15.9	1400	-	1600	330	389	2.0	10.9	6864	
	440	56	3	6964	-	-	-	-	-	-	266000	370000	16.4	1300	-	1500	331	429	2.5	24.1	6964	
	480	74	4	6064	-	-	-	-	-	-	340000	470000	15.3	1200	-	1400	333	467	3.0	46.1	6064	

Deep-groove Ball Bearings

With snap ring groove / With snap ring / Shield type with snap ring

Bore Diameter: 10~30mm

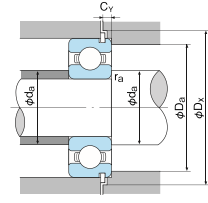
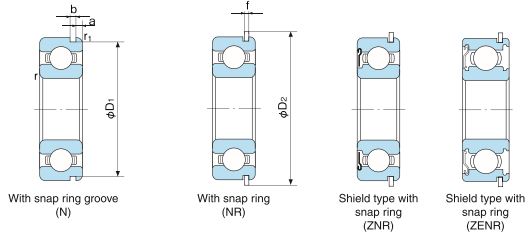

Dynamic equivalent radial load
 $P_r = XFr + YFa$

Static equivalent radial load
 Larger value of following to be used:
 $P_{or} = 0.6Fr + 0.5Fa$
 $P_{or} = Fr$

$\frac{f_0 Fa}{C_{or}}$	e	$\frac{Fa}{Fr} \leq e$		$\frac{Fa}{Fr} > e$	
		X	Y	X	Y
0.172	0.19				2.30
0.345	0.22	1	0	0.56	1.99
0.689	0.26				1.71
1.03	0.28				1.55
1.38	0.30	1	0	0.56	1.45
2.07	0.34				1.31
3.45	0.38				1.15
5.17	0.42	1	0	0.56	1.04
6.89	0.44				1.00

Boundary dimensions (mm)			Dimensions of snap ring groove and snap ring (mm)						Bearing No. (1)			Basic dynamic load rating Cr (N)	Basic static load rating Cor (N)	Factor fo	Limiting speed (min ⁻¹)		Abutment and fillet dimensions (mm)					Mass (kg)	Bearing No.	
d	D	B	r (min)	r1 (min)	D1 (max)	a (max)	b (min)	D2 (max)	f (max)	Grease lubrication	Oil lubrication				da (min)	Da (max)	Dx (min)	ra (max)	Cy (max)					
10	22	6	0.3	0.3	20.8	1.05	0.8	24.8	0.7	6900N	6900NR	6900ZENR	2490	1130	14.0	33000	38000	12	20	25.5	0.3	1.5	0.010	6900N
	30	9	0.6	0.5	28.17	2.06	1.35	34.7	1.12	6200N	6200NR	6200ZENR	5100	2390	13.2	25000	30000	15	25	35.5	0.6	2.9	0.032	6200N
	35	11	0.6	0.5	33.17	2.06	1.35	39.7	1.12	6300N	6300NR	6300ZENR	8100	3450	11.3	23000	27000	15	30	40.5	0.6	2.9	0.053	6300N
12	24	6	0.3	0.3	22.8	1.05	0.8	26.8	0.7	6901N	6901NR	6901ZENR	2700	1320	14.5	30000	36000	14	22	27.5	0.3	1.5	0.012	6901N
	28	8	0.3	0.3	26.7	1.35	0.93	31	0.85	6001N	6001NR	6001ZENR	5100	2390	13.5	28000	32000	14	26	31.5	0.3	1.9	0.024	6001N
	32	10	0.6	0.5	30.15	2.06	1.35	36.7	1.12	6201N	6201NR	6201ZENR	6800	3050	12.3	22000	28000	17	27	37.5	0.6	2.9	0.037	6201N
15	28	7	0.3	0.3	26.7	1.3	0.95	30.8	0.85	6902N	6902NR	6902ZENR	4300	2250	14.3	26000	31000	17	26	31.5	0.3	1.8	0.017	6902N
	32	9	0.3	0.3	30.15	2.06	1.35	36.7	1.12	6002N	6002NR	6002ZENR	5600	2840	13.9	24000	28000	17	30	37.5	0.3	2.9	0.033	6002N
	35	11	0.6	0.5	33.17	2.06	1.35	39.7	1.12	6202N	6202NR	6202ZENR	7650	3700	13.1	20000	24000	20	30	40.5	0.6	2.9	0.045	6202N
17	42	13	1	0.5	39.75	2.06	1.35	46.3	1.12	6302N	6302NR	6302ZENR	11400	5400	12.3	17000	21000	21	36	47	1	2.9	0.082	6302N
	30	7	0.3	0.3	28.7	1.3	0.95	32.8	0.85	6903N	6903NR	6903ZENR	4600	2550	14.7	24000	29000	19	28	33.5	0.3	1.8	0.019	6903N
	35	10	0.3	0.3	33.17	2.06	1.35	39.7	1.12	6003N	6003NR	6003ZENR	6000	3250	14.3	22000	26000	19	33	40.5	0.3	2.9	0.041	6003N
20	40	12	0.6	0.5	38.1	2.06	1.35	44.6	1.12	6203N	6203NR	6203ZENR	9550	4800	13.1	18000	21000	22	35	45.5	0.6	2.9	0.065	6203N
	47	14	1	0.5	44.6	2.46	1.35	52.7	1.12	6303N	6303NR	6303ZENR	13600	6550	12.3	16000	19000	23	41	53.5	1	3.3	0.115	6303N
	32	7	0.3	0.3	30.7	1.3	0.95	34.8	0.85	6804N	6804NR	6804ZENR	4000	2640	15.5	22000	26000	22	30	35.5	0.3	1.8	0.020	6804N
22	37	9	0.3	0.3	35.7	1.7	0.95	39.8	0.85	6904N	6904NR	6904ZENR	6350	3700	14.8	19000	23000	22	35	40.5	0.3	2.3	0.037	6904N
	42	12	0.6	0.5	39.75	2.06	1.35	46.3	1.12	6004N	6004NR	6004ZENR	9400	5000	13.9	18000	21000	24	38	47	0.6	2.9	0.069	6004N
	47	14	1	0.5	44.6	2.46	1.35	52.7	1.12	6204N	6204NR	6204ZENR	12800	6600	13.1	16000	18000	26	41	53.5	1	3.3	0.106	6204N
25	52	15	1.1	0.5	49.73	2.46	1.35	57.9	1.12	6304N	6304NR	6304ZENR	15900	7900	12.4	14000	17000	27	45	58.5	1	3.3	0.144	6304N
	50	14	1	0.5	47.6	2.46	1.35	55.7	1.12	62/22N	62/22NR	62/22ZENR	13900	6950	13.1	14000	17000	28	44	56.5	1	3.3	0.120	62/22N
	56	16	1.1	0.5	53.6	2.46	1.35	61.7	1.12	63/22N	63/22NR	63/22ZENR	18400	9250	12.4	13000	16000	29	49	62.5	1	3.3	0.176	63/22N
28	37	7	0.3	0.3	35.7	1.3	0.95	39.8	0.85	6805N	6805NR	6805ZENR	4300	2940	16.0	18000	22000	27	35	40.5	0.3	1.8	0.023	6805N
	42	9	0.3	0.3	40.7	1.7	0.95	44.8	0.85	6905N	6905NR	6905ZENR	7000	4500	15.3	16000	20000	27	40	45.5	0.3	2.3	0.044	6905N
	47	12	0.6	0.5	44.6	2.06	1.35	52.7	1.12	6005N	6005NR	6005ZENR	10100	5850	14.5	15000	18000	29	43	53.5	0.6	2.9	0.078	6005N
30	52	15	1	0.5	49.73	2.46	1.35	57.9	1.12	6205N	6205NR	6205ZENR	14000	7900	13.9	13000	16000	31	46	58.5	1	3.3	0.128	6205N
	62	17	1.1	0.5	59.61	3.28	1.9	67.7	1.7	6305N	6305NR	6305ZENR	23600	12100	12.2	12000	14000	32	55	68.5	1	4.6	0.232	6305N
	58	16	1	0.5	55.6	2.46	1.35	63.7	1.12	62/28N	62/28NR	62/28ZENR	17900	9750	13.1	12000	14000	34	52	64.5	1	3.3	0.175	62/28N
30	68	18	1.1	0.5	64.82	3.28	1.9	74.6	1.7	63/28N	63/28NR	63/28ZENR	26800	14000	12.4	11000	13000	35	61	76	1	4.6	0.287	63/28N
	42	7	0.3	0.3	40.7	1.3	0.95	44.8	0.85	6806N	6806NR	6806ZENR	5350	3800	16.4	15000	18000	32	40	45.5	0.3	1.8	0.027	6806N
	47	9	0.3	0.3	45.7	1.7	0.95	49.8	0.85	6906N	6906NR	6906ZENR	7250	5000	15.8	14000	17000	32	45	50.5	0.3	2.3	0.047	6906N
30	55	13	1	0.5	52.6	2.08	1.35	60.7	1.12	6006N	6006NR	6006ZENR	13200	8300	14.8	13000	15000	35	50	61.5	1	2.9	0.113	6006N
	62	16	1	0.5	59.61	3.28	1.9	67.7	1.7	6206N	6206NR	6206ZENR	19500	11300	13.9	11000	13000	36	56	68.5	1	4.6	0.199	6206N
	72	19	1.1	0.5	68.81	3.28	1.9	78.6	1.7	6306N	6306NR	6306ZENR	26700	15000	13.2	10000	12000	37	65	80	1	4.6	0.346	6306N

Note: (*) Bearing No. ZE means one shield type, two shields type is also available.
 Remark: Dimensions of snap ring groove and snap ring are shown on pages 45 to 48.

Deep-groove Ball Bearings
 With snap ring groove / With snap ring / Shield type with snap ring
 Bore Diameter: 32~60mm

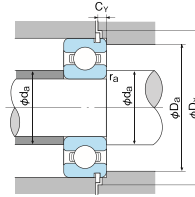
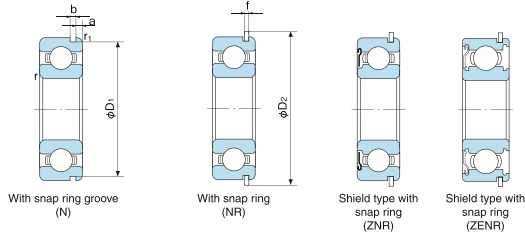

■ **Dynamic equivalent radial load**
 $P_r = XFr + YFa$

■ **Static equivalent radial load**
 Larger value of following to be used:
 $P_{or} = 0.6Fr + 0.5Fa$
 $P_{or} = Fr$

$\frac{f_0 F_a}{C_{or}}$	e	X	Y	$\frac{F_a}{F_r}$	X	Y
0.172	0.19					2.30
0.345	0.22	1	0	0.56		1.99
0.689	0.26					1.71
1.03	0.28					1.55
1.38	0.30	1	0	0.56		1.45
2.07	0.34					1.31
3.45	0.38					1.15
5.17	0.42	1	0	0.56		1.04
6.89	0.44					1.00

Boundary dimensions (mm)				Dimensions of snap ring groove and snap ring (mm)					Bearing No. (1)			Basic dynamic load rating Cr (N)	Basic static load rating Cor (N)	Factor fo	Limiting speed (min ⁻¹)		Abutment and fillet dimensions (mm)					Mass (kg)	Bearing No.	
d	D	B	r (min)	r1 (min)	D1 (max)	a (max)	b (min)	D2 (max)	f (max)						Grease lubrication	Oil lubrication	da (min)	Da (max)	Dx (min)	ra (max)	Cy (max)			
32	65	17	1	0.5	62.6	3.28	1.9	70.7	1.7	62/32N	62/32NR	62/32ZNR	22400	13100	13.6	11000	12000	38	59	71.5	1	4.6	0.230	62/32N
	75	20	1.1	0.5	71.83	3.28	1.9	81.6	1.7	63/32N	63/32NR	63/32ZNR	30000	16200	12.7	9500	11000	39	68	83	1	4.6	0.382	63/32N
	47	7	0.3	0.3	45.7	1.3	0.95	49.8	0.85	6807N	6807NR	6807ZENR	4750	3800	16.4	14000	16000	37	45	50.5	0.3	1.8	0.030	6807N
35	55	10	0.6	0.5	53.7	1.7	0.95	57.8	0.85	6907N	6907NR	6907ZENR	10400	7150	15.6	12000	15000	39	51	58.5	0.6	2.3	0.075	6907N
	62	14	1	0.5	59.61	2.08	1.9	67.7	1.7	6007N	6007NR	6007ZENR	16000	10300	14.8	12000	14000	40	57	68.5	1	3.4	0.150	6007N
	72	17	1.1	0.5	68.81	3.28	1.9	78.6	1.6	6207N	6207NR	6207ZENR	25700	15300	13.8	9800	11000	42	65	80	1	4.6	0.288	6207N
	80	21	1.5	0.5	76.81	3.28	1.9	86.6	1.6	6307N	6307NR	6307ZENR	33500	19100	13.2	8800	10000	44	71	88	1.5	4.6	0.457	6307N
	52	7	0.3	0.3	50.7	1.3	0.95	54.8	0.85	6808N	6808NR	6808ZENR	5950	4900	16.2	12000	14000	42	50	55.5	0.3	1.8	0.034	6808N
40	62	12	0.6	0.5	60.7	1.7	0.95	64.8	0.85	6908N	6908NR	6908ZENR	13700	9950	15.8	11000	13000	44	58	65.5	0.6	2.3	0.110	6908N
	68	15	1	0.5	64.82	2.49	1.9	74.6	1.7	6008N	6008NR	6008ZENR	16800	11500	15.3	10000	12000	45	63	76	1	3.8	0.186	6008N
	80	18	1.1	0.5	76.81	3.28	1.9	86.6	1.7	6208N	6208NR	6208ZENR	29100	17900	14.0	8700	10000	47	73	88	1	4.6	0.366	6208N
	90	23	1.5	0.5	86.79	3.28	2.7	96.5	2.46	6308N	6308NR	6308ZENR	40500	24100	13.2	7800	9200	49	81	98	1.5	5.9	0.633	6308N
45	58	7	0.3	0.3	56.7	1.3	0.95	60.8	0.85	6809N	6809NR	6809ZENR	5350	4900	16.1	11000	13000	47	56	61.5	0.3	1.8	0.042	6809N
	68	12	0.6	0.5	66.7	1.7	0.95	70.8	0.85	6909N	6909NR	6909ZENR	14100	10900	16.1	10000	12000	49	64	72	0.6	2.3	0.124	6909N
	75	16	1	0.5	71.83	2.49	1.9	81.6	1.7	6009N	6009NR	6009ZENR	20900	15200	15.3	9200	11000	50	70	83	1	3.8	0.239	6009N
	85	19	1.1	0.5	81.81	3.28	1.9	91.6	1.7	6209N	6209NR	6209ZENR	32500	20500	14.1	7800	9300	52	78	93	1	4.6	0.407	6209N
50	100	25	1.5	0.5	96.8	3.28	2.7	106.5	2.46	6309N	6309NR	6309ZENR	53000	32000	13.1	7000	8200	54	91	108	1.5	5.4	0.833	6309N
	65	7	0.3	0.3	63.7	1.3	0.95	67.8	0.85	6810N	6810NR	6810ZENR	6400	5800	16.1	10000	12000	52	63	68.5	0.3	1.8	0.054	6810N
	72	12	0.6	0.5	70.7	1.7	0.95	74.8	0.85	6910N	6910NR	6910ZENR	14500	11700	16.1	9500	11000	54	68	76	0.6	2.3	0.127	6910N
	80	16	1	0.5	76.81	2.49	1.9	86.6	1.7	6010N	6010NR	6010ZENR	21800	16600	15.6	8500	10000	55	75	88	1	3.8	0.252	6010N
	90	20	1.1	0.5	86.79	3.28	2.7	96.5	2.46	6210N	6210NR	6210ZENR	35000	23200	14.4	7100	8600	57	83	98	1	5.4	0.463	6210N
55	110	27	2	0.5	106.81	3.28	2.7	116.6	2.46	6310N	6310NR	6310ZENR	62000	38100	13.1	6400	7500	60	100	118	2	5.4	1.07	6310N
	72	9	0.3	0.3	70.7	1.7	0.95	74.8	0.85	6811N	6811NR	6811ZENR	8900	8100	16.2	8700	10000	57	70	76	0.3	2.3	0.085	6811N
	80	13	1	0.5	77.9	2.1	1.3	84.4	1.12	6911N	6911NR	6911ZENR	16000	13200	16.2	8200	9600	60	75	86	1	2.9	0.180	6911N
	90	18	1.1	0.5	86.79	2.87	2.7	96.5	2.46	6011N	6011NR	6011ZENR	28300	21300	15.4	7700	9000	61	84	98	1	5	0.375	6011N
	100	21	1.5	0.5	96.8	3.28	2.7	106.5	2.46	6211N	6211NR	6211ZENR	43500	29300	14.4	6400	7700	64	91	108	1.5	5.4	0.607	6211N
60	120	29	2	0.5	115.21	4.06	3.1	129.7	2.82	6311N	6311NR	6311ZENR	71500	44500	13.1	5800	6800	65	110	131.5	2	6.5	1.37	6311N
	78	10	0.3	0.3	76.2	1.7	1.3	82.7	1.12	6812N	6812NR	6812ZENR	11500	10600	16.3	8000	9500	62	76	84	0.3	2.5	0.110	6812N
	85	13	1	0.5	82.9	2.1	1.3	89.4	1.12	6912N	6912NR	6912ZENR	15200	13500	16.5	7600	9000	65	80	91	1	2.9	0.195	6912N
	95	18	1.1	0.5	91.82	2.87	2.7	101.6	2.46	6012N	6012NR	6012ZENR	29400	23200	15.5	7100	8500	66	89	103	1	5	0.403	6012N
	110	22	1.5	0.5	106.81	3.28	2.7	116.6	2.46	6212N	6212NR	6212ZENR	52500	36000	14.3	6000	7100	69	101	118	1.5	5.4	0.783	6212N
130	31	2.1	0.5	125.22	4.06	3.1	139.7	2.82	6312N	6312NR	6312ZENR	82000	52000	13.2	5400	6300	72	118	141.5	2	6.5	1.70	6312N	

Note: (1) Bearing No. ZE means one shield type, two shields type is also available.
 Remark: Dimensions of snap ring groove and snap ring are shown on pages 45 to 48.

Deep-groove Ball Bearings
 With snap ring groove / With snap ring / Shield type with snap ring
 Bore Diameter: 65~90mm

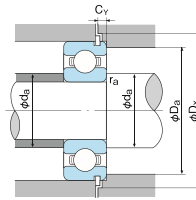
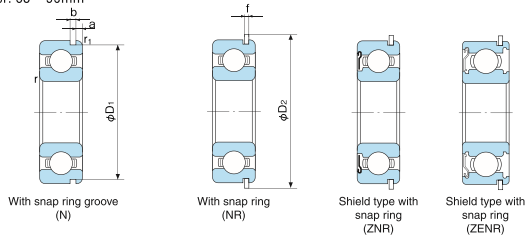

■ **Dynamic equivalent radial load**
 $P_r = XFr + YFa$

■ **Static equivalent radial load**
 Larger value of following to be used:
 $P_{or} = 0.6Fr + 0.5Fa$
 $P_{or} = Fr$

$f_0 Fa$ Cor	e	$\frac{Fa}{Fr} \leq e$		$\frac{Fa}{Fr} > e$	
		X	Y	X	Y
0.172	0.19				2.30
0.345	0.22	1	0	0.56	1.99
0.689	0.26				1.71
1.03	0.28				1.55
1.38	0.30	1	0	0.56	1.45
2.07	0.34				1.31
3.45	0.38				1.15
5.17	0.42	1	0	0.56	1.04
6.89	0.44				1.00

Boundary dimensions (mm)			Dimensions of snap ring groove and snap ring (mm)					Bearing No. (*)			Basic dynamic load rating Cr (N)	Basic static load rating Cor (N)	Factor fo	Limiting speed (min ⁻¹)		Abutment and fillet dimensions (mm)					Mass (kg)	Bearing No.		
d	D	B	r (min)	r1 (min)	D1 (max)	a (max)	b (min)	D2 (max)	f (max)	Grease lubrication				Oil lubrication	da (min)	Da (max)	Dx (min)	ra (max)	Cy (max)					
65	85	10	0.6	0.5	82.9	1.7	1.3	89.4	1.12	6813N	6813NR	6813ZNR	11900	11500	16.2	7500	8700	69	81	91	0.6	2.5	0.130	6813N
	90	13	1	0.5	87.9	2.1	1.3	94.4	1.12	6913N	6913NR	6913ZNR	17400	16000	16.5	7100	8500	70	85	96	1	2.9	0.210	6913N
	100	18	1.1	0.5	96.8	2.87	2.7	106.5	2.46	6013N	6013NR	6013ZENR	30500	25200	15.7	6700	8000	71	94	108	1	5	0.413	6013N
	120	23	1.5	0.5	115.21	4.06	3.1	129.7	2.82	6213N	6213NR	6213ZENR	57000	40000	14.4	5500	6500	74	111	131.5	1.5	6.5	0.990	6213N
	140	33	2.1	0.5	135.23	4.9	3.1	149.7	2.82	6313N	6313NR	6313ZENR	92500	59500	13.2	4900	6000	77	128	152	2	7.3	2.08	6313N
70	90	10	0.6	0.5	87.9	1.7	1.3	94.4	1.12	6814N	6814NR	6814ZNR	12100	11900	16.1	7000	8100	74	86	96	0.6	2.5	0.140	6814N
	100	16	1	0.5	97.9	2.5	1.3	104.4	1.12	6914N	6914NR	6914ZNR	23700	21100	16.3	6500	7700	75	95	106	1	3.3	0.332	6914N
	110	20	1.1	0.5	106.81	2.87	2.7	116.6	2.46	6014N	6014NR	6014ZENR	38000	31000	15.6	6100	7100	76	104	118	1	5	0.580	6014N
	125	24	1.5	0.5	120.22	4.06	3.1	134.7	2.82	6214N	6214NR	6214ZENR	62000	44000	14.4	5100	6300	79	116	136.5	1.5	6.5	1.07	6214N
	150	35	2.1	0.5	145.24	4.9	3.1	159.7	2.82	6314N	6314NR	6314ZENR	104000	68000	13.2	4600	5400	82	138	162	2	7.3	2.52	6314N
75	95	10	0.6	0.5	92.9	1.7	1.3	99.4	1.12	6815N	6815NR	6815ZNR	12500	12800	16.0	6500	7600	79	91	101	0.6	2.5	0.150	6815N
	105	16	1	0.5	102.6	2.5	1.3	110.7	1.12	6915N	6915NR	6915ZNR	20800	19700	16.5	6200	7200	80	100	112	1	3.3	0.350	6915N
	115	20	1.1	0.5	111.81	2.87	2.7	121.6	2.46	6015N	6015NR	6015ZENR	39500	33500	15.7	5700	6700	81	109	123	1	5	0.615	6015N
	130	25	1.5	0.5	125.22	4.06	3.1	139.7	2.82	6215N	6215NR	6215ZENR	66000	49500	14.7	4800	5600	84	121	141.5	1.5	6.5	1.18	6215N
	160	37	2.1	0.5	155.22	4.9	3.1	169.7	2.82	6315N	6315NR	6315ZENR	113000	77000	13.2	4300	5000	87	148	172	2	7.3	3.02	6315N
80	100	10	0.6	0.5	97.9	1.7	1.3	104.4	1.12	6816N	6816NR	6816ZNR	12700	13300	15.9	6000	7100	84	96	106	0.6	2.5	0.160	6816N
	110	16	1	0.5	107.6	2.5	1.3	115.7	1.12	6916N	6916NR	6916ZNR	27600	25300	16.4	5700	6700	85	105	117	1	3.3	0.370	6916N
	125	22	1.1	0.5	120.22	2.87	3.1	134.7	2.82	6016N	6016NR	6016ZENR	47500	39500	15.6	5300	6300	86	119	136.5	1	5.3	0.825	6016N
	140	26	2	0.5	135.23	4.9	3.1	149.7	2.82	6216N	6216NR	6216ZENR	72500	53000	14.6	4500	5300	90	130	152	2	7.3	1.40	6216N
	170	39	2.1	0.5	163.65	5.69	3.5	182.9	3.1	6316N	6316NR	6316ZENR	123000	86500	13.2	4000	4800	92	158	185	2	8.4	3.59	6316N
85	110	13	1	0.5	107.6	2.1	1.3	115.7	1.12	6817N	6817NR	6817ZNR	18700	19000	16.2	5700	6700	90	105	117	1	2.9	0.272	6817N
	120	18	1.1	0.5	117.6	3.3	1.3	125.7	1.12	6917N	6917NR	6917ZNR	32000	29600	16.4	5400	6300	91	113	127	1	4.1	0.524	6917N
	130	22	1.1	0.5	125.22	2.87	3.1	139.7	2.82	6017N	6017NR	6017ZENR	49500	43000	15.7	5000	6000	91	124	141.5	1	5.3	0.863	6017N
	150	28	2	0.5	145.24	4.9	3.1	159.7	2.82	6217N	6217NR	6217ZENR	84000	62000	14.5	4300	5000	95	140	162	2	7.3	1.79	6217N
	180	41	3	0.5	173.66	5.69	3.5	192.9	3.1	6317N	6317NR	6317ZENR	133000	96500	13.3	3800	4500	99	166	195	2.5	8.4	4.23	6317N
90	115	13	1	0.5	112.6	2.1	1.3	120.7	1.2	6818N	6818NR	6818ZNR	19000	19700	16.1	5400	6300	95	110	122	1	2.9	0.288	6818N
	125	18	1.1	0.5	122.6	3.3	1.3	130.7	1.12	6918N	6918NR	6918ZNR	33000	31500	16.4	5100	6000	96	119	132	1	4.1	0.549	6918N
	140	24	1.5	0.5	135.23	3.71	3.1	149.7	2.82	6018N	6018NR	6018ZENR	58000	49500	15.6	4800	5600	97	133	152	1.5	6.1	1.13	6018N
	160	30	2	0.5	155.22	4.9	3.1	169.7	2.82	6218N	6218NR	6218ZENR	96000	71500	14.5	4000	4800	100	150	172	2	7.3	2.15	6218N
	190	43	3	0.5	183.64	5.69	3.5	202.9	3.1	6318N	6318NR	6318ZENR	143000	107000	13.3	3600	4300	104	176	205	2.5	8.4	4.91	6318N

Note: (*) Bearing No. ZE means one shield type, two shields type is also available.
 Remark: Dimensions of snap ring groove and snap ring are shown on pages 45 to 48.

Deep-groove Ball Bearings
 With snap ring groove / With snap ring / Shield type with snap ring
 Bore Diameter: 95~130mm

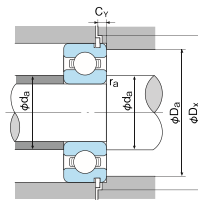
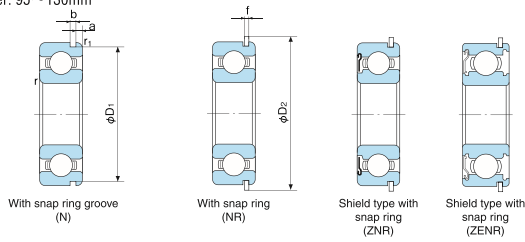

Dynamic equivalent radial load
 $P_r = XFr + YFa$
Static equivalent radial load
 Larger value of following to be used:
 $P_{0r} = 0.6Fr + 0.5Fa$
 $P_{0r} = Fr$

$\frac{f_0 Fa}{Cor}$	e	$\frac{Fa}{Fr} \leq e$		$\frac{Fa}{Fr} > e$	
		X	Y	X	Y
0.172	0.19				2.30
0.345	0.22	1	0	0.56	1.99
0.689	0.26				1.71
1.03	0.28				1.55
1.38	0.30	1	0	0.56	1.45
2.07	0.34				1.31
3.45	0.38				1.15
5.17	0.42	1	0	0.56	1.04
6.89	0.44				1.00

Boundary dimensions (mm)					Dimensions of snap ring groove and snap ring (mm)					Bearing No. (*)			Basic dynamic load rating Cr (N)	Basic static load rating Cor (N)	Factor fo	Limiting speed (min ⁻¹)		Abutment and fillet dimensions (mm)					Mass (kg)	Bearing No.
d	D	B	r (min)	r1 (min)	D1 (max)	a (max)	b (min)	D2 (max)	f (max)							Grease lubrication	Oil lubrication	da (min)	Da (max)	Dx (min)	ra (max)	Cy (max)		
95	120	13	1	0.5	117.6	2.1	1.3	125.7	1.12	6819N	6819NR	6819ZNR	19300	20500	16.0	5000	6000	100	115	127	1	2.9	0.307	6819N
	130	18	1.1	0.5	127.6	3.3	1.3	135.7	1.12	6919N	6919NR	6919ZNR	33500	33500	16.5	4800	5700	101	124	137	1	4.1	0.576	6919N
	145	24	1.5	0.5	140.23	3.71	3.1	154.7	2.82	6019N	6019NR	6019ZNR	60500	54000	15.8	4500	5300	102	138	157	1.5	6.1	1.16	6019N
	170	32	2.1	0.5	163.65	5.69	3.5	182.9	3.1	6219N	6219NR	6219ZNR	109000	81500	14.4	3800	4500	107	158	185	2	8.4	2.62	6219N
	200	45	3	0.5	193.65	5.69	3.5	212.9	3.1	6319N	6319NR	6319ZNR	153000	118000	13.3	3300	3900	109	186	215	2.5	8.4	5.67	6319N
100	125	13	1	0.5	122.6	2.1	1.3	130.7	1.12	6820N	6820NR	6820ZNR	19600	21200	16.0	4800	5600	105	120	132	1	2.9	0.320	6820N
	140	20	1.1	0.5	137.6	3.3	1.9	145.7	1.7	6920N	6920NR	6920ZNR	37000	36500	16.5	4500	5300	106	134	147	1	4.7	0.780	6920N
	150	24	1.5	0.5	145.24	3.71	3.1	159.7	2.82	6020N	6020NR	6020ZNR	60000	54000	15.9	4300	5300	107	143	162	1.5	6.1	1.20	6020N
	180	34	2.1	0.5	173.66	5.69	3.5	192.9	3.1	6220N	6220NR	6220ZNR	122000	93000	14.4	3600	4300	112	168	195	2	8.4	3.14	6220N
105	130	13	1	0.5	127.6	2.1	1.3	135.7	1.12	6821N	6821NR	6821ZNR	19900	21900	15.9	4800	5600	110	125	137	1	2.9	0.335	6821N
	145	20	1.1	0.5	142.6	3.3	1.9	150.7	1.7	6921N	6921NR	6921ZNR	42500	42000	16.4	4300	5300	111	139	152	1	4.7	0.803	6921N
	160	26	2	0.5	155.22	3.71	3.1	169.7	2.82	6021N	6021NR	6021ZNR	72500	65500	15.8	4000	4800	113	152	172	2	6.1	1.54	6021N
	190	36	2.1	0.5	183.64	5.69	3.5	202.9	3.1	6221N	6221NR	6221ZNR	133000	104000	14.3	3400	4000	117	178	205	2	8.4	3.76	6221N
110	140	16	1	0.5	137.6	2.5	1.9	145.7	1.7	6822N	6822NR	6822ZNR	27300	29400	16.9	4300	5300	115	135	147	1	3.9	0.526	6822N
	150	20	1.1	0.5	147.6	3.3	1.9	155.7	1.7	6922N	6922NR	6922ZNR	38000	38500	16.4	4300	5000	116	144	157	1	4.7	0.846	6922N
	170	28	2	0.5	163.65	3.71	3.5	182.9	3.1	6022N	6022NR	6022ZNR	84500	73000	15.5	3800	4500	118	162	185	2	6.4	1.91	6022N
	200	38	2.1	0.5	193.65	5.69	3.5	212.9	3.1	6222N	6222NR	6222ZNR	144000	117000	14.3	3200	3800	122	188	215	2	8.4	4.36	6222N
120	150	16	1	0.5	147.6	2.5	1.9	155.7	1.7	6824N	6824NR	6824ZNR	28300	31500	16.0	4000	4800	125	145	157	1	3.9	0.567	6824N
	165	22	1.1	0.5	161.8	3.7	1.9	171.5	1.7	6924N	6924NR	6924ZNR	53000	54000	16.5	3800	4600	126	159	173	1	5.1	1.15	6924N
	180	28	2	0.5	173.66	3.71	3.5	192.9	3.1	6024N	6024NR	6024ZNR	88000	79500	15.7	3600	4300	128	172	195	2	6.4	2.36	6024N
130	165	18	1.1	0.5	161.8	3.3	1.9	171.5	1.7	6826N	6826NR	6826ZNR	37000	41000	16.1	3700	4400	136	158	173	1	4.7	0.815	6826N
	180	24	1.5	0.5	176.8	3.7	1.9	186.5	1.7	6926N	6926NR	6926ZNR	65000	67000	16.4	3500	4200	137	173	188	1.5	5.1	1.81	6926N
	200	33	2	0.5	193.65	5.69	3.5	212.9	3.1	6026N	6026NR	6026ZNR	106000	101000	15.7	3200	3800	138	192	215	2	8.4	3.60	6026N

Note: (*) Bearing No. ZE means one shield type, two shields type is also available.
 Remark: Dimensions of snap ring groove and snap ring are shown on pages 45 to 48.



Angular Contact Ball Bearings

Tolerance Page 52
 Preload Page 95

● **Design**

Angular Contact Ball Bearings can sustain combined loads of simultaneously acting radial and axial loads because they have a contact angle (α).

The contact angle is defined as the angle between the line joining the points of contact between the ball and the raceways in the radial plane.

1. Single-row Angular Contact Ball Bearings

These bearings are designed with three contact angle classifications as shown in Table 1. Normally, contact angle A design and B design are fitted with a cage as shown in Table 2-1. High precision (JIS/ISO class 5 or higher) may be fitted with a machined cage of bronze or

phenolic resin or a polyamide cage. Contact angle C design are generally applied high precision, JIS (ISO) class 5 or higher, and are fitted with a machined phenolic resin cage or a polyamide cage.

Table 1. Contact Angle and Characteristics of Single-row Angular Contact Ball Bearings

Contact Angle Symbol	Example Bearing No.	Contact Angle (α)	Speed	Load capability comparison ⁽²⁾		Cross section
				Radial Load Direction (X)	Axial Load Direction (Y)	
A	7205 ⁽¹⁾	30°	—	—	—	
B	7205B	40°	Less	Less	Greater	
C	7205C	15°	Greater	Greater	Less	

Notes: ⁽¹⁾ Contact angle symbol "A" is omitted.
⁽²⁾ Axial load can be accommodated in one direction only.

Table 2-1. Angular Contact Ball Bearing Cage for Contact Angle Symbol A and B (For JIS/ISO class 0 or 6)

	Applicable Bore Diameter Number	
	Pressed Steel	Machined Brass
72, 72B	00~22	24~40
73, 73B	00~19	20~40

Table 2-2. Angular Contact Ball Bearing Cage for Contact Angle Symbol C

	Applicable Bore Diameter Number	
	Machined Synthetic Resin	Polyamide
70C	00~40	00~20
72C	00~26	00~20
73C	00~22	—

2. Combination Angular Contact Ball Bearings

Single-row Angular Contact Ball Bearings are seldom used as a single unit. Normally they are used as a combination of two and more units. High precision paired combination Angular Contact Ball Bearings (JIS/ISO class 5 or higher) are used for applications such as machine tool spindles and are usually preloaded. Three types of combinations are available:

- 1) DB, back - to - back
- 2) DF, face - to - face

3) DT, tandem

Because clearance of matched set parts is adjusted before shipment, care should be taken to prevent mixing of parts from other sets.

Load-carrying capability of combined Angular Contact Bearings are shown in Table 3.

Flush ground bearings or Universal matching bearings are also available.

DU can be mounted as back-to-back, face-to-face or in tandem.

Table 3. Load-carrying Characteristics of Combination Angular Contact Ball Bearings

Configuration	Load Center Distance (a)	Load Capability	Moment Load Rigidity	Cross Section
Back - to - Back (DB)	Long		Greater	
Face - to - Face (DF)	Short		Less	
Tandem (DT)	-		-	

3. Double-row Angular Contact Ball Bearings

This type bearings is made in two contact angle levels as shown in Table 4. They are selected according to sustained axial and moment load. Pressed steel cage are used for them. Some sizes of Double-row Angular Contact Ball Bearing are available with contact seals (2NS) or shields (ZZ).

Table 4. Double-row Angular Contact Ball Bearing Contact Angles and Symbols

Contact Angle Symbol	Contact Angle (α)	Example Bearing No.
None	20°	5205
A	30°	5205A

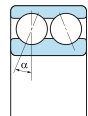

● Flush ground set combinations (Universal matching)

NACHI Angular Contact Ball Bearings with a suffix U are flush ground to permit the use of random combinations where two or more bearings are mounted.

7206B U

7206CY U P4

Flush ground (free set matching)

● Speed Limits

With respect to single-row or combination bearings, the dimension tables show limiting speed for bearings made with machined cages or a polyamide cages. For bearings made with pressed-cages, multiply the table limit by 0.8. For contact angle C design bearings, the table limiting speeds are applied to high precision bearings of class 5 or higher.

These limiting speeds can be applied when a

high quality grease or oil is supplied in proper quantity under light load conditions. When Angular Contact Ball Bearings are used in combination of two or more units, or with larger preload to improve rigidity, the limiting speed must be decreased. Please contact NACHI for design assistance.

● Attention

- (1) If bearings are operated under severe conditions such as close to limiting speed, high temperature, or vibrating load, please consult NACHI.
- (2) Bearings with polyamide cage should be use at less than 120°C.
- (3) Combination Angular Contact Ball Bearings should not be mixed with those of other bearings.
- (4) When combination bearings with an optional preload is required, please contact NACHI.

Angular Contact Ball Bearings Single Mounting / Duplex Mounting

Bore Diameter: 10~17mm

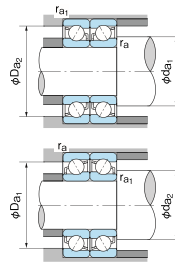
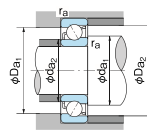
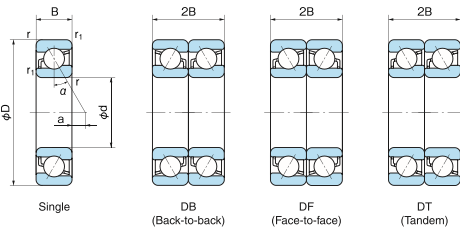

Dynamic equivalent radial load

$$Pr = XFr + YFa$$

Contact angle	iFa/Cor	e	Single or DT		DB or DF			
			Fa/Fr > e		Fa/Fr ≤ e		Fa/Fr > e	
			X	Y	X	Y	X	Y
15°	0.015	0.38	1.47	1.65	2.39	2.28	2.11	2.00
	0.029	0.40	1.40	1.57	2.28	2.11	2.00	
	0.058	0.43	1.30	1.46	2.11	2.00	1.82	
	0.087	0.46	1.23	1.38	2.00	1.82	1.66	
	0.12	0.47	1.19	1.34	1.82	1.66	1.51	
	0.17	0.50	1.12	1.26	1.66	1.51	1.38	
30°	0.29	0.55	1.02	1.14	1.51	1.38	1.24	
	0.44	0.56	1.00	1.12	1.38	1.24	1.12	
	0.58	0.56	1.00	1.12	1.24	1.12	0.93	
40°	0.8	0.39	0.76	1.00	0.63	0.57	0.57	
	1.14	0.35	0.57	1.00	0.57	0.57	0.57	

Static equivalent radial load

$$Por = XoFr + YoFa$$

Contact angle	Xo	Yo	Single or DT		DB or DF	
			Xo	Yo	Xo	Yo
			Xo	Yo	Xo	Yo
15°	0.5	0.46	1	0.92	1	0.92
30°	0.5	0.33	1	0.66	1	0.66
40°	0.5	0.26	1	0.52	1	0.52

Single or DT mounting: When $Por < Fr$, use $Pr = Fr$

- i = 2 for DB or DF mounting
- i = 1 for Single or DT mounting
- Single or DT mounting: When $Fa/Fr ≤ e$, use $Pr = Fr$

1N=0.102kgf

Boundary dimensions (mm)								Load center (mm)	Bearing No.				Basic dynamic load rating Cr (N)		Basic static load rating Cor (N)				Limiting speed (min ⁻¹)				Abutment and fillet dimensions (mm)						Mass (kg)	Bearing No.
d	D	B	r (min)	r1 (min)	a	Single			Duplex		Single	Duplex	Grease lubrication		Oil lubrication		d11 (min)	d12 (min)	D11 (max)	D12 (max)	ra (max)	r11 (max)	r12 (max)							
Single	Duplex	Single	Duplex	Single	Duplex	Single	Duplex		Single	Duplex			Single	Duplex	Single	Duplex														
10	26	8	0.3	0.15	1.2	7000	7000DB	7000DF	7000DT	5000	8150	2340	4650	23000	19000	31000	26000	12	12	24	25	0.3	0.15	0.022	7000					
	26	8	0.3	0.15	-1.9	7000C	7000CDB	7000CDF	7000CDT	5350	8700	2500	5000	44000	35000	61000	49000	12	12	24	25	0.3	0.15	0.022	7000C					
	30	9	0.6	0.3	1.3	7200	7200DB	7200DF	7200DT	5400	8800	2710	5400	22000	18000	30000	24000	15	12	25	27.4	0.6	0.3	0.034	7200					
	30	9	0.6	0.3	3.9	7200B	7200BDB	7200BDF	7200BDT	5150	8350	2570	5150	19000	16000	28000	22000	15	12	25	27.4	0.6	0.3	0.034	7200B					
	30	9	0.6	0.3	-2.2	7200C	7200CDB	7200CDF	7200CDT	6950	11300	3300	6650	40000	32000	55000	44000	15	15	25	27.4	0.6	0.3	0.034	7200C					
	35	11	0.6	0.3	1.0	7300	7300DB	7300DF	7300DT	9300	15100	4300	8600	20000	16000	26000	21000	15	12	30	32.4	0.6	0.3	0.055	7300					
12	35	11	0.6	0.3	3.9	7300B	7300BDB	7300BDF	7300BDT	8950	14500	4150	8250	18000	14000	24000	19000	15	12	30	32.4	0.6	0.3	0.055	7300B					
	35	11	0.6	0.3	-2.8	7300C	7300CDB	7300CDF	7300CDT	9850	16000	4600	9250	36000	29000	49000	39000	15	15	30	32.4	0.6	0.3	0.055	7300C					
	28	8	0.3	0.15	1.7	7001	7001DB	7001DF	7001DT	5050	8800	2710	5700	22000	18000	29000	23000	14	14	26	27	0.3	0.15	0.024	7001					
	28	8	0.3	0.15	-1.7	7001C	7001CDB	7001CDF	7001CDT	5800	9450	2910	5800	40000	32000	55000	44000	14	14	26	27	0.3	0.15	0.024	7001C					
	32	10	0.6	0.3	1.4	7201	7201DB	7201DF	7201DT	7600	12400	3960	7950	20000	16000	27000	22000	17	14	27	29.4	0.6	0.3	0.040	7201					
	32	10	0.6	0.3	4.2	7201B	7201BDB	7201BDF	7201BDT	7200	11700	3800	7550	17000	15000	24000	20000	17	14	27	29.4	0.6	0.3	0.040	7201B					
15	32	10	0.6	0.3	-2.5	7201C	7201CDB	7201CDF	7201CDT	7950	13000	3900	7750	36000	29000	50000	40000	17	17	27	29.4	0.6	0.3	0.040	7201C					
	37	12	1	0.6	1.1	7301	7301DB	7301DF	7301DT	11200	18200	5250	10500	18000	15000	24000	20000	18	15	31	33.4	1	0.6	0.063	7301					
	37	12	1	0.6	4.3	7301B	7301BDB	7301BDF	7301BDT	10800	17500	5050	10100	16000	13000	22000	18000	18	15	31	33.4	1	0.6	0.063	7301B					
	37	12	1	0.6	-3.1	7301C	7301CDB	7301CDF	7301CDT	10800	17500	4900	9800	33000	26000	45000	36000	18	18	31	33.4	1	0.6	0.063	7301C					
	32	9	0.3	0.15	2.3	7002	7002DB	7002DF	7002DT	6150	9950	3400	6850	18000	15000	24000	20000	17	17	30	31	0.3	0.15	0.035	7002					
	32	9	0.3	0.15	-1.8	7002C	7002CDB	7002CDF	7002CDT	6650	10800	3700	7450	34000	27000	47000	38000	17	17	30	31	0.3	0.15	0.035	7002C					
17	35	11	0.6	0.3	1.7	7202	7202DB	7202DF	7202DT	9050	14700	4700	9400	17000	14000	23000	19000	20	17	30	32.4	0.6	0.3	0.048	7202					
	35	11	0.6	0.3	5.0	7202B	7202BDB	7202BDF	7202BDT	8600	14000	4500	8950	16000	12000	21000	17000	20	17	30	32.4	0.6	0.3	0.048	7202B					
	35	11	0.6	0.3	-2.6	7202C	7202CDB	7202CDF	7202CDT	8700	14200	4550	9150	32000	26000	44000	35000	20	20	30	32.4	0.6	0.3	0.048	7202C					
	42	13	1	0.6	1.7	7302	7302DB	7302DF	7302DT	13600	22000	7100	14200	16000	13000	21000	17000	21	18	36	38.4	1	0.6	0.085	7302					
	42	13	1	0.6	5.5	7302B	7302BDB	7302BDF	7302BDT	12800	21000	6750	13500	14000	11000	19000	16000	21	18	36	38.4	1	0.6	0.085	7302B					
	42	13	1	0.6	-3.1	7302C	7302CDB	7302CDF	7302CDT	13300	21700	6850	13700	28000	22000	39000	31000	21	21	36	38.4	1	0.6	0.085	7302C					

Remarks: 1. "a" means the distance between back face and load center.
 2. See page 122 regarding limiting speeds.

Angular Contact Ball Bearings Single Mounting / Duplex Mounting

Bore Diameter: 80~95mm

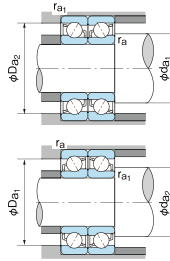
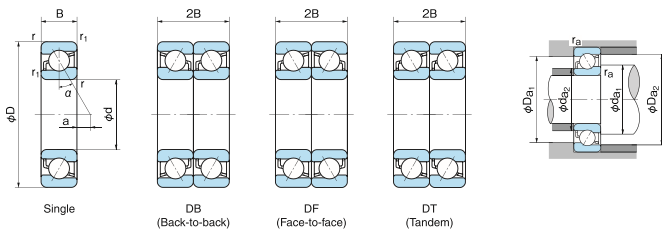

Dynamic equivalent radial load

Pr = XFr + YFa

Table with columns for Contact angle, iFa Cor, e, Single or DT (Fa/Fr > e, X, Y), DB or DF (Fa/Fr <= e, X, Y), and values for contact angles 15, 30, and 40 degrees.

Static equivalent radial load

Por = XoFr + YoFa

Table with columns for Contact angle, Single or DT (Xo, Yo), DB or DF (Xo, Yo), and values for contact angles 15, 30, and 40 degrees.

- i = 2 for DB or DF mounting
i = 1 for Single or DT mounting
Single or DT mounting When Fa/Fr <= e, use Pr = Fr

1N=0.102kgf

Main bearing specification table with columns for Boundary dimensions (mm), Load center (mm), Bearing No., Basic dynamic load rating Cr (N), Basic static load rating Cor (N), Limiting speed (min-1), Abutment and fillet dimensions (mm), Mass (kg), and Bearing No.

Remarks: 1. "a" means the distance between back face and load center.
2. See page 122 regarding limiting speeds.

Angular Contact Ball Bearings Single Mounting / Duplex Mounting

Bore Diameter: 130~160mm

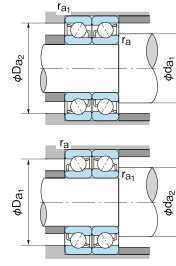
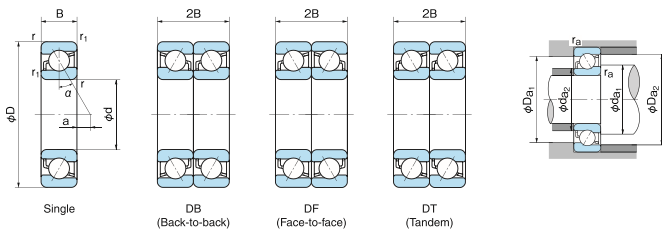

Dynamic equivalent radial load

$P_r = XFr + YFa$

Contact angle	iFa/Cor	e	Single or DT		DB or DF	
			X	Y	X	Y
15°	0.015	0.38	X	1.47	1.65	2.39
	0.029	0.40	0.44	1.40	1.57	2.28
	0.058	0.43	1.30	1.46	1.66	2.11
	0.087	0.46	1.23	1.38	2.00	2.11
	0.12	0.47	0.44	1.19	1.34	0.72
	0.17	0.50	1.12	1.26	1.82	1.93
	0.29	0.55	1.02	1.14	1.66	1.93
	0.44	0.56	0.44	1.00	1.12	0.72
	0.58	0.56	1.00	1.12	1.63	1.63
	0.72	0.56	1.00	1.12	1.63	1.63
30°	—	0.8	0.39	0.76	1	0.78
40°	—	1.14	0.35	0.57	1	0.55

Static equivalent radial load

$P_{0r} = X_0Fr + Y_0Fa$

Contact angle	Single or DT		DB or DF	
	X ₀	Y ₀	X ₀	Y ₀
15°	0.5	0.46	1	0.92
30°	0.5	0.33	1	0.66
40°	0.5	0.26	1	0.52

Single or DT mounting When $P_{0r} < Fr$, use $P_r = Fr$

- i = 2 for DB or DF mounting
- i = 1 for Single or DT mounting
- Single or DT mounting When $Fa/Pr \leq e$, use $P_r = Fr$

1N=0.102kgf

Boundary dimensions (mm)					Load center (mm)	Bearing No.				Basic dynamic load rating Cr (N)		Limiting speed (min ⁻¹)				Abutment and fillet dimensions (mm)					Mass (kg)	Bearing No.			
d	D	B	r (min)	r ₁ (min)		Single	Duplex			Single	Duplex	Grease lubrication		Oil lubrication		d ₁ (min)	d ₂ (min)	D ₁ (max)	D ₂ (max)	r _a (max)			r _{a1} (max)		
130	200	33	2	1	31.1	7026	7026DB	7026DF	7026DT	117000	190000	125000	250000	2600	2200	3600	2700	138	138	192	195	2	1	3.43	7026
	200	33	2	1	2.5	7026C	7026CDB	7026CDF	7026CDT	130000	211000	138000	276000	4800	3800	6700	5400	138	138	192	195	2	1	3.43	7026C
	230	40	3	1.1	32	7226	7226DB	7226DF	7226DT	196000	320000	198000	395000	2400	1900	3100	2500	144	137	216	223	2.5	1	6.88	7226
	230	40	3	1.1	55.5	7226B	7226BDB	7226BDF	7226BDT	184000	298000	185000	370000	2100	1700	2800	2300	144	137	216	223	2.5	1	6.88	7226B
	230	40	3	1.1	0.9	7226C	7226CDB	7226CDF	7226CDT	214000	350000	216000	430000	4400	3500	6100	4900	144	144	216	223	2.5	1	6.88	7226C
	280	58	4	1.5	30.2	7326	7326DB	7326DF	7326DT	300000	490000	330000	660000	2200	1700	2900	2200	148	139	262	271	3	1.5	17.4	7326
	280	58	4	1.5	57.0	7326B	7326BDB	7326BDF	7326BDT	284000	460000	310000	620000	1900	1500	2600	2000	148	139	262	271	3	1.5	17.4	7326B
	210	33	2	1	34	7028	7028DB	7028DF	7028DT	120000	194000	133000	265000	2400	1900	3300	2600	148	148	202	205	2	1	3.63	7028
	210	33	2	1	3.7	7028C	7028CDB	7028CDF	7028CDT	133000	216000	148000	292000	4600	3700	6300	5000	148	148	202	205	2	1	3.63	7028C
	250	42	3	1.1	35.3	7228	7228DB	7228DF	7228DT	211000	345000	228000	525000	2200	1800	3000	2400	154	147	236	243	2.5	1	8.78	7228
140	250	42	3	1.1	60.8	7228B	7228BDB	7228BDF	7228BDT	197000	320000	214000	425000	2000	1600	2600	2200	154	147	236	243	2.5	1	8.78	7228B
	250	42	3	1.1	1.3	7228C	7228CDB	7228CDF	7228CDT	223000	360000	235000	470000	4100	3300	5600	4500	154	154	236	243	2.5	1	8.78	7228C
	300	62	4	1.5	32.5	7328	7328DB	7328DF	7328DT	300000	490000	335000	670000	2000	1600	2600	2000	158	149	282	291	3	1.5	21.5	7328
	300	62	4	1.5	61.3	7328B	7328BDB	7328BDF	7328BDT	284000	460000	315000	635000	1700	1400	2400	1900	158	149	282	291	3	1.5	21.5	7328B
	225	35	2.1	1.1	36.6	7030	7030DB	7030DF	7030DT	137000	222000	154000	305000	2300	1800	3000	2400	159	159	216	219	2	1	4.42	7030
	225	35	2.1	1.1	4.1	7030C	7030CDB	7030CDF	7030CDT	152000	247000	169000	340000	4300	3400	5900	4700	159	159	216	219	2	1	4.42	7030C
	270	45	3	1.1	38.1	7230	7230DB	7230DF	7230DT	249000	405000	280000	560000	2000	1600	2800	2200	164	157	256	263	2.5	1	11.0	7230
	270	45	3	1.1	65.6	7230B	7230BDB	7230BDF	7230BDT	223000	360000	246000	490000	1800	1500	2600	2000	164	157	256	263	2.5	1	11.0	7230B
	270	45	3	1.1	1.5	7230C	7230CDB	7230CDF	7230CDT	261000	425000	287000	575000	3800	3000	5200	4200	164	164	256	263	2.5	1	11.0	7230C
	320	65	4	1.5	35.3	7330	7330DB	7330DF	7330DT	330000	535000	380000	765000	1700	1400	2400	1800	168	159	302	311	3	1.5	25.1	7330
160	320	65	4	1.5	66.1	7330B	7330BDB	7330BDF	7330BDT	310000	505000	360000	725000	1500	1300	2200	1600	168	159	302	311	3	1.5	25.1	7330B
	240	38	2.1	1.1	38.7	7032	7032DB	7032DF	7032DT	155000	252000	176000	350000	2100	1700	2800	2300	169	169	231	234	2	1	5.44	7032
	240	38	2.1	1.1	4.1	7032C	7032CDB	7032CDF	7032CDT	172000	280000	194000	390000	4000	3200	5500	4400	169	169	231	234	2	1	5.44	7032C
	290	48	3	1.1	41.0	7232	7232DB	7232DF	7232DT	263000	425000	305000	615000	1900	1500	2600	2000	174	167	276	283	2.5	1	13.7	7232
	290	48	3	1.1	70.4	7232B	7232BDB	7232BDF	7232BDT	246000	400000	287000	575000	1700	1400	2200	1800	174	167	276	283	2.5	1	13.7	7232B
	290	48	3	1.1	2.4	7232C	7232CDB	7232CDF	7232CDT	288000	470000	335000	670000	3600	2900	4900	3900	174	167	276	283	2.5	1	13.7	7232C
	340	68	4	1.5	38.2	7332	7332DB	7332DF	7332DT	345000	565000	420000	845000	1700	1400	2200	1800	178	169	322	331	3	1.5	30.2	7332
	340	68	4	1.5	70.9	7332B	7332BDB	7332BDF	7332BDT	325000	530000	395000	795000	1500	1200	2000	1600	178	169	322	331	3	1.5	30.2	7332B

Remarks: 1. "a" means the distance between back face and load center.
2. See page 122 regarding limiting speeds.

Angular Contact Ball Bearings Single Mounting / Duplex Mounting

Bore Diameter: 170~200mm

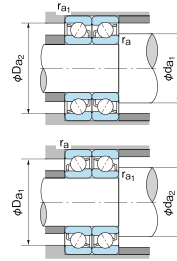
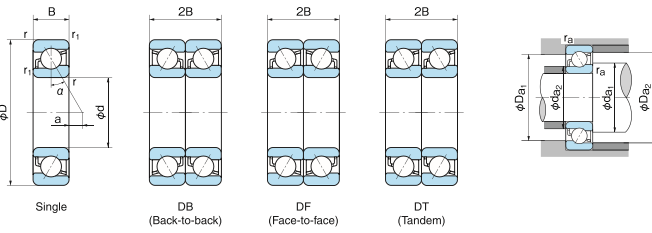

Dynamic equivalent radial load

$P_r = X F_r + Y F_a$

Contact angle	iFa Cor	e	Single or DT		DB or DF		X	Y
			Fa/Fr > e	Fa/Fr ≤ e	Fa/Fr > e	Fa/Fr ≤ e		
15°	0.015	0.38	X	Y	1.47	1.65		
	0.029	0.40	0.44	1	1.40	1.57	0.72	2.28
	0.058	0.43	1.30	1.46				2.11
	0.087	0.46		1.23	1.38	2.00		
	0.12	0.47	0.44	1.19	1	1.34	0.72	1.93
	0.17	0.50		1.12	1.26	1.82		
	0.29	0.55		1.02	1.14	1.66		
	0.44	0.56	0.44	1.00	1	1.12	0.72	1.63
30°	0.58	0.56	1.00	1.12	1.63			
	—	—	0.8	0.39	0.76	1	0.78	0.63
40°	—	—	1.14	0.35	0.57	1	0.55	0.57

Static equivalent radial load

$P_{or} = X_0 F_r + Y_0 F_a$

Contact angle	X0	Y0	Single or DT		DB or DF	
			X0	Y0	X0	Y0
15°	0.5	0.46	1	0.92		
30°	0.5	0.33	1	0.66		
40°	0.5	0.26	1	0.52		

- i = 2 for DB or DF mounting
- i = 1 for Single or DT mounting
- Single or DT mounting When Fa/Fr ≤ e, use Pr = Fr

Single or DT mounting When Por < Fr, use Pr = Fr

d	Boundary dimensions (mm)					Load center (mm) a	Bearing No.				Basic dynamic load rating Cr (N)		Basic static load rating Cor (N)				Limiting speed (min ⁻¹)				Abutment and fillet dimensions (mm)				Mass (kg) Single	Bearing No.
	D	B	r (min)	r1 (min)			Single	Duplex			Single	Duplex	Grease lubrication		Oil lubrication		dR1 (min)	dR2 (min)	D1 (max)	D2 (max)	ra (max)	ra1 (max)				
	Single	Duplex	Single	Duplex	Single		Duplex	Single	Duplex	Single	Duplex	Single	Duplex	Single	Duplex	Single	Duplex	Single	Duplex	Single	Duplex					
170	260	42	2.1	1.1	41.1	7034	7034DB	7034DF	7034DT	179000	291000	210000	420000	2000	1600	2600	2100	179	179	251	254	2	1	7.87	7034	
	260	42	2.1	1.1	3.8	7034C	7034CDB	7034CDF	7034CDT	206000	335000	236000	470000	3700	3000	5100	4100	179	179	251	254	2	1	7.87	7034C	
	310	52	4	1.5	43.3	7234	7234DB	7234DF	7234DT	272000	440000	330000	660000	1800	1400	2400	1900	188	179	292	301	3	1.5	17.4	7234	
	310	52	4	1.5	74.7	7234B	7234BDB	7234BDF	7234BDT	254000	410000	310000	620000	1600	1300	2200	1700	188	179	292	301	3	1.5	17.4	7234B	
	310	52	4	1.5	2.2	7234C	7234CDB	7234CDF	7234CDT	299000	485000	360000	725000	3300	2600	4600	3700	188	179	292	301	3	1.5	17.4	7234C	
	360	72	4	1.5	40.5	7334	7334DB	7334DF	7334DT	390000	630000	485000	970000	1600	1300	2200	1700	188	179	342	351	3	1.5	35.7	7334	
	360	72	4	1.5	75.2	7334B	7334BDB	7334BDF	7334BDT	365000	595000	460000	915000	1400	1100	2000	1600	188	179	342	351	3	1.5	35.7	7334B	
	360	72	4	1.5	43.4	7036	7036DB	7036DF	7036DT	207000	335000	252000	505000	1900	1500	2500	2000	189	189	271	274	2	1	9.98	7036	
180	280	46	2.1	1.1	3.5	7036C	7036CDB	7036CDF	7036CDT	235000	385000	290000	580000	3500	2800	4800	3800	189	189	271	274	2	1	9.98	7036C	
	320	52	4	1.5	46.2	7236	7236DB	7236DF	7236DT	281000	455000	350000	705000	1700	1300	2200	1800	198	189	302	311	3	1.5	19.9	7236	
	320	52	4	1.5	48.9	7236B	7236BDB	7236BDF	7236BDT	262000	425000	330000	660000	1500	1200	2000	1700	198	189	302	311	3	1.5	19.9	7236B	
	320	52	4	1.5	3.3	7236C	7236CDB	7236CDF	7236CDT	310000	500000	385000	775000	3200	2600	4400	3500	198	189	302	311	3	1.5	19.9	7236C	
	380	75	4	1.5	43.3	7336	7336DB	7336DF	7336DT	410000	665000	535000	1070000	1400	1200	2000	1600	198	189	362	371	3	1.5	41.3	7336	
	380	75	4	1.5	80.0	7336B	7336BDB	7336BDF	7336BDT	385000	625000	505000	1010000	1300	1100	1900	1500	198	189	362	371	3	1.5	41.3	7336B	
	290	46	2.1	1.1	46.3	7038	7038DB	7038DF	7038DT	218000	355000	277000	555000	1800	1400	2300	1900	199	199	281	284	2	1	10.7	7038	
	290	46	2.1	1.1	4.7	7038C	7038CDB	7038CDF	7038CDT	248000	405000	310000	615000	3300	2600	4600	3700	199	199	281	284	2	1	10.7	7038C	
190	340	55	4	1.5	49.0	7238	7238DB	7238DF	7238DT	315000	510000	410000	825000	1600	1300	2200	1700	208	199	322	331	3	1.5	21.5	7238	
	340	55	4	1.5	83.7	7238B	7238BDB	7238BDF	7238BDT	294000	475000	385000	770000	1400	1100	2000	1600	208	199	322	331	3	1.5	21.5	7238B	
	400	78	5	2	46.1	7338	7338DB	7338DF	7338DT	445000	725000	610000	1220000	1400	1100	1900	1500	212	200	378	390	4	2	47.6	7338	
	400	78	5	2	84.8	7338B	7338BDB	7338BDF	7338BDT	420000	680000	575000	1150000	1300	1000	1800	1400	212	200	378	390	4	2	47.6	7338B	
	310	51	2.1	1.1	48.1	7040	7040DB	7040DF	7040DT	226000	365000	277000	565000	1700	1300	2200	1800	209	209	301	304	2	1	13.8	7040	
	310	51	2.1	1.1	3.9	7040C	7040CDB	7040CDF	7040CDT	274000	445000	360000	715000	3100	2500	4300	3400	209	209	301	304	2	1	13.8	7040C	
	360	58	4	1.5	51.8	7240	7240DB	7240DF	7240DT	335000	550000	450000	900000	1500	1200	2000	1600	218	209	342	351	3	1.5	25.5	7240	
	360	58	4	1.5	88.5	7240B	7240BDB	7240BDF	7240BDT	315000	510000	420000	840000	1300	1000	1900	1500	218	209	342	351	3	1.5	25.5	7240B	
200	420	80	5	2	49.5	7340	7340DB	7340DF	7340DT	475000	770000	655000	1310000	1300	1100	1800	1400	222	210	398	410	4	2	53.7	7340	
	420	80	5	2	90.1	7340B	7340BDB	7340BDF	7340BDT	445000	725000	620000	1240000	1200	1000	1700	1300	222	210	398	410	4	2	53.7	7340B	

Remarks: 1. "a" means the distance between back face and load center.
2. See page 122 regarding limiting speeds.

Double-row Angular Contact Ball Bearings

Bore Diameter: 10~45mm

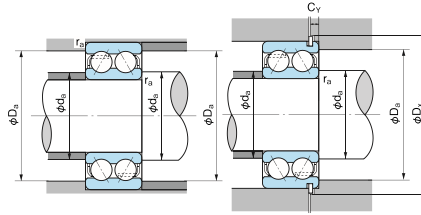
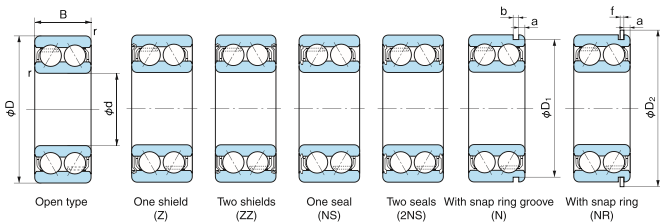

Dynamic equivalent radial load
 $F_r = XFr + YFa$

Contact angle	e	$Fa/Fr \leq e$		$Fa/Fr > e$	
		X	Y	X	Y
30°	0.80	1.0	0.78	0.63	1.24
20°	0.57	1.0	1.09	0.70	1.63

Static equivalent radial load
Nominal contact angle 30° : $F_{st} = Fr + 0.66Fa$
Nominal contact angle 20° : $F_{st} = Fr + 0.84Fa$

Boundary dimensions (mm)				Bearing No.						Basic dynamic load rating Cr (N)	Basic static load rating Cor (N)	Limiting speed (min ⁻¹)		Dimensions of snap ring groove and snap ring (mm)						Abutment and fillet dimensions (mm)					Mass (kg)	Bearing No.
d	D	B	r (min)	Open type	Shield type		Seal type		With snap ring groove			With snap ring	Grease lubrication	Oil lubrication	D ₁ (max)	a (max)	b (min)	D ₂ (max)	f (max)	d _a (min)	D _a (max)	D _x (min)	r _a (max)	C _y (max)		
10	30	14.3	0.6	5200	5200Z	5200ZZ	5200NS	5200-2NS	5200N	5200NR	7300	4000	18000	24000	28.17	2.06	1.35	34.7	1.12	15	25	35.5	0.6	2.9	0.050	5200
	30	14.3	0.6	5200A	5200AZ	5200AZZ	5200ANS	5200A-2NS	5200AN	5200ANR	6950	3800	16000	22000	28.17	2.06	1.35	34.7	1.12	15	25	35.5	0.6	2.9	0.050	5200A
12	32	15.9	0.6	5201	5201Z	5201ZZ	5201NS	5201-2NS	5201N	5201NR	10700	5950	16000	22000	30.15	2.06	1.35	36.7	1.12	17	27	37.5	0.6	2.9	0.060	5201
	32	15.9	0.6	5201A	5201AZ	5201AZZ	5201ANS	5201A-2NS	5201AN	5201ANR	10300	5650	15000	20000	30.15	2.06	1.35	36.7	1.12	17	27	37.5	0.6	2.9	0.060	5201A
15	35	15.9	0.6	5202	5202Z	5202ZZ	5202NS	5202-2NS	5202N	5202NR	11900	7200	14000	19000	33.17	2.06	1.35	39.7	1.12	20	30	40.5	0.6	2.9	0.070	5202
	35	15.9	0.6	5202A	5202AZ	5202AZZ	5202ANS	5202A-2NS	5202AN	5202ANR	11400	6850	12000	17000	33.17	2.06	1.35	39.7	1.12	20	30	40.5	0.6	2.9	0.070	5202A
17	40	17.5	0.6	5203	5203Z	5203ZZ	5203NS	5203-2NS	5203N	5203NR	15000	9250	12000	17000	38.1	2.06	1.35	44.6	1.12	22	35	45.5	0.6	2.9	0.090	5203
	40	17.5	0.6	5203A	5203AZ	5203AZZ	5203ANS	5203A-2NS	5203AN	5203ANR	14200	8800	11000	15000	38.1	2.06	1.35	44.6	1.12	22	35	45.5	0.6	2.9	0.090	5203A
20	47	22.2	1	5303	--	--	--	--	5303N	5303NR	21300	12700	10000	14000	44.6	2.46	1.35	52.7	1.12	23	41	53.5	1	3.3	0.140	5303
	47	20.6	1	5204	5204Z	5204ZZ	5204NS	5204-2NS	5204N	5204NR	20000	12700	9500	13000	44.6	2.46	1.35	52.7	1.12	26	41	53.5	1	3.3	0.120	5204
25	52	22.2	1.1	5304	--	--	--	--	5304N	5304NR	21700	13300	9000	11000	49.73	2.46	1.35	57.9	1.12	27	45	58.5	1	3.3	0.230	5304
	52	20.6	1	5205	5205Z	5205ZZ	5205NS	5205-2NS	5205N	5205NR	21800	15100	8000	11000	49.73	2.46	1.35	57.9	1.12	31	46	58.8	1	3.3	0.190	5205
30	62	23.8	1	5206	--	--	--	--	5206N	5206NR	30500	21700	8000	11000	59.61	3.28	1.9	67.7	1.7	36	56	68.5	1	4.7	0.290	5206
	62	23.8	1	5206A	5206AZ	5206AZZ	5206ANS	5206A-2NS	5206AN	5206ANR	28600	20500	7000	9500	59.61	3.28	1.9	67.7	1.7	36	56	68.5	1	4.7	0.290	5206A
35	72	27	1.1	5207	--	--	--	--	5207N	5207NR	40000	29500	7000	9500	68.81	3.28	1.9	78.6	1.7	42	65	80	1	4.7	0.430	5207
	72	27	1.1	5207A	5207AZ	5207AZZ	5207ANS	5207A-2NS	5207AN	5207ANR	38000	27700	6000	8000	68.81	3.28	1.9	78.6	1.7	42	65	80	1	4.7	0.430	5207A
40	80	34.9	1.5	5307	--	--	--	--	5307N	5307NR	52000	37000	6300	8500	76.81	3.28	1.9	86.6	1.7	44	71	88	1.5	4.7	0.790	5307
	80	30.2	1.1	5208	--	--	--	--	5208N	5208NR	45500	34000	6000	8000	76.81	3.28	1.9	86.6	1.7	47	73	88	1	4.7	0.570	5208
45	85	30.2	1.1	5209	--	--	--	--	5209N	5209NR	51000	39000	5500	7500	86.79	3.28	2.7	96.5	2.46	49	81	98	1.5	5.4	1.05	5209
	85	30.2	1.1	5209A	5209AZ	5209AZZ	5209ANS	5209A-2NS	5209AN	5209ANR	48000	37000	5000	6700	81.81	3.28	1.9	91.6	1.7	52	78	93	1	4.7	0.620	5209A
100	100	39.7	1.5	5309	--	--	--	--	5309N	5309NR	76500	56500	5000	6700	96.8	3.28	2.7	106.5	2.46	54	91	108	1.5	5.4	1.42	5309

Remark: Dimensions and tolerances of snap ring groove and snap ring are shown on pages 45 to 48.

Double-row Angular Contact Ball Bearings

Bore Diameter: 50~85mm

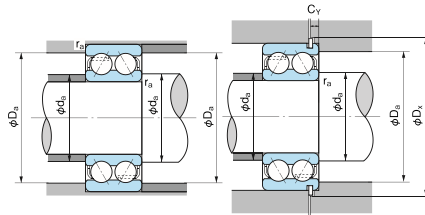
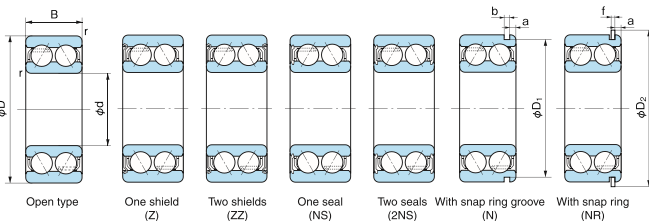

Dynamic equivalent radial load
 $F_r = XFr + YFa$

Contact angle	e	X		Y		e		X		Y	
		≤ e	> e	≤ e	> e	≤ e	> e	≤ e	> e		
30°	0.80	1.0	0.78	0.63	1.24	1.63					
20°	0.57	1.0	1.09	0.70	1.63						

Static equivalent radial load
 Nominal contact angle 30°: $P_0r = Fr + 0.66Fa$
 Nominal contact angle 20°: $P_0r = Fr + 0.84Fa$

1N=0.102kgf

Boundary dimensions (mm)				Bearing No.						Basic dynamic load rating Cr (N)	Basic static load rating Cor (N)	Limiting speed (min ⁻¹)		Dimensions of snap ring groove and snap ring (mm)						Abutment and fillet dimensions (mm)					Mass (kg)	Bearing No.
d	D	B	r (min)	Open type	Shield type		Seal type		With snap ring groove	With snap ring			Grease lubrication	Oil lubrication	D ₁ (max)	a (max)	b (min)	D ₂ (max)	f (max)	d _a (min)	D _a (max)	D _z (min)	r _a (max)	C _r (max)		
50	90	30.2	1.1	5210					5210N	5210NR	54500	44500	5000	6700	86.79	3.28	2.7	96.5	2.46	57	83	98	1	5.4	0.670	5210
	90	30.2	1.1	5210Z	5210ZZ	5210NS	5210-2NS					45000	39000	5000						57	83		1		0.670	5210Z
	90	30.2	1.1	5210A					5210AN	5210ANR	51000	42000	4500	6000	86.79	3.28	2.7	96.5	2.46	57	83	98	1	5.4	0.670	5210A
	90	30.2	1.1	5210AZ	5210AZZ	5210ANS	5210A-2NS					42000	36500	4500						57	83		1		0.670	5210AZ
	110	44.4	2	5310					5310N	5310NR	90000	68000	4500	6000	106.81	3.28	2.7	116.6	2.46	60	100	118	2	5.4	1.93	5310
55	100	33.3	1.5	5211					5211N	5211NR	67500	56500	4500	6300	96.8	3.28	2.7	106.5	2.46	64	91	108	1.5	5.4	0.960	5211
	100	33.3	1.5	5211Z	5211ZZ							57500	50500	4500						64	91		1.5		0.960	5211Z
	100	33.3	1.5	5211A					5211AN	5211ANR	63500	53000	4000	5500	96.8	3.28	2.7	106.5	2.46	64	91	108	1.5	5.4	0.960	5211A
	100	33.3	1.5	5211AZ	5211AZZ							54000	47500	4000						64	91		1.5		0.960	5211AZ
	120	49.2	2	5311					5311N	5311NR	112000	86500	4000	5500	115.21	4.06	3.1	129.7	2.82	65	110	131.5	2	6.5	2.30	5311
60	110	36.5	1.5	5212					5212N	5212NR	76000	62000	4300	5600	106.81	3.28	2.7	116.6	2.46	69	101	118	1.5	5.4	1.36	5212
	110	36.5	1.5	5212Z	5212ZZ						67000	57500	4300						69	101		1.5		1.36	5212Z	
	110	36.5	1.5	5212A					5212AN	5212ANR	71500	58500	3800	5000	106.81	3.28	2.7	116.6	2.46	69	101	118	1.5	5.4	1.36	5212A
	110	36.5	1.5	5212AZ	5212AZZ						63000	54000	3800						69	101		1.5		1.36	5212AZ	
130	54	2.1	5312					5312N	5312NR	128000	101000	3800	5000	125.22	4.06	3.1	139.7	2.82	72	118	141.5	2	6.5	3.16	5312	
65	120	38.1	1.5	5213					5213N	5213NR	89000	77000	3900	5300	115.21	4.06	3.1	129.7	2.82	74	111	131.5	1.5	6.5	1.66	5213
	120	38.1	1.5	5213Z	5213ZZ						78500	71000	3900						74	111		1.5		1.66	5213Z	
	120	38.1	1.5	5213A					5213AN	5213ANR	83500	72500	3400	4600	115.21	4.06	3.1	129.7	2.82	74	111	131.5	1.5	6.5	1.66	5213A
	120	38.1	1.5	5213AZ	5213AZZ						73500	66500	3400						74	111		1.5		1.66	5213AZ	
	140	58.7	2.1	5313					5313N	5313NR	145000	115000	3600	4700	135.23	4.9	3.1	149.7	2.82	77	128	152	2	7.4	3.86	5313
70	125	39.7	1.5	5214					5214N	5214NR	96500	84500	3800	5000	120.22	4.06	3.1	134.7	2.82	79	116	136.5	1.5	6.5	1.82	5214
	125	39.7	1.5	5214Z	5214ZZ						86000	79000	3800						79	116		1.5		1.82	5214Z	
	125	39.7	1.5	5214A					5214AN	5214ANR	90500	79500	3200	4500	120.22	4.06	3.1	134.7	2.82	79	116	136.5	1.5	6.5	1.82	5214A
	125	39.7	1.5	5214AZ	5214AZZ						80500	74000	3200						79	116		1.5		1.82	5214AZ	
	150	63.5	2.1	5314					5314N	5314NR	163000	132000	3200	4300	145.24	4.9	3.1	159.7	2.82	82	138	162	2	7.4	4.88	5314
75	130	41.3	1.5	5215					5215N	5215NR	96000	85500	3400	4700	125.22	4.06	3.1	139.7	2.82	84	121	141.5	1.5	6.5	1.91	5215
	130	41.3	1.5	5215Z	5215ZZ						94000	87000	3400						84	121		1.5		1.91	5215Z	
	130	41.3	1.5	5215A					5215AN	5215ANR	90000	80500	3200	4300	125.22	4.06	3.1	139.7	2.82	84	121	141.5	1.5	6.5	1.91	5215A
	130	41.3	1.5	5215AZ	5215AZZ						88000	81500	3200						84	121		1.5		1.91	5215AZ	
	160	68.3	2.1	5315					5315N	5315NR	178000	149000	3000	4000	155.22	4.9	3.1	169.7	2.82	87	148	172	2	7.4	5.51	5315
80	140	44.4	2	5216					5216N	5216NR	104000	94000	3500	4600	135.23	4.9	3.1	149.7	2.82	90	130	152	2	7.4	2.48	5216
	140	44.4	2	5216A					5216AN	5216ANR	97500	88500	2800	4000	135.23	4.9	3.1	149.7	2.82	90	130	152	2	7.4	2.48	5216A
	170	68.3	2.1	5316					5316N	5316NR	192000	167000	2800	4000	163.65	5.69	3.5	182.9	3.1	92	158	185	2	8.4	6.81	5316
85	150	49.2	2	5217					5217N	5217NR	112000	103000	3000	4000	145.24	4.9	3.1	159.7	2.82	95	140	162	2	7.4	3.40	5217
	150	49.2	2	5217A					5217AN	5217ANR	105000	96500	2600	3800	145.24	4.9	3.1	159.7	2.82	95	140	162	2	7.4	3.40	5217A

Remark: Dimensions and tolerances of snap ring groove and snap ring are shown on pages 45 to 46.

Double-row Angular Contact Ball Bearings

Bore Diameter: 90~100mm

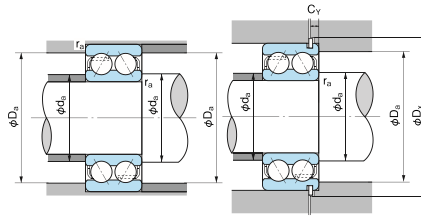
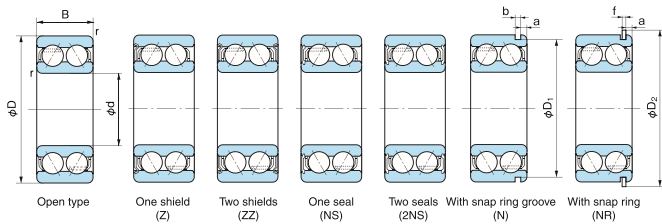

Dynamic equivalent radial load
Fr=XFr+YFa

Contact angle	e	Fa/Fr ≤ e		Fa/Fr > e	
		X	Y	X	Y
30°	0.80	1.0	0.78	0.63	1.24
20°	0.57	1.0	1.09	0.70	1.63

Static equivalent radial load
Nominal contact angle 30° : Por=Fr+0.66Fa
Nominal contact angle 20° : Por=Fr+0.84Fa

1N=0.102kgf

Boundary dimensions (mm)				Bearing No.								Basic dynamic load rating Cr (N)	Basic static load rating Cor (N)	Limiting speed (min ⁻¹)		Dimensions of snap ring groove and snap ring (mm)						Abutment and fillet dimensions (mm)					Mass (kg)	Bearing No.
d	D	B	r (min)	Open type	Shield type		Seal type		With snap ring groove	With snap ring	Grease lubrication			Oil lubrication	D1 (max)	a (max)	b (min)	D2 (max)	f (max)	da (min)	Da (max)	Dx (min)	ra (max)	Cy (max)				
90	160	52.4	2	5218	—	—	—	—	5218N	5218NR	138000	133000	2700	3900	155.22	4.9	3.1	169.7	2.82	100	150	172	2	7.4	4.28	5218		
	160	52.4	2	5218A	—	—	—	—	5218AN	5218ANR	129000	125000	2500	3500	155.22	4.9	3.1	169.7	2.82	100	150	172	2	7.4	4.28	5218A		
95	170	55.6	2.1	5219	—	—	—	—	5219N	5219NR	149000	139000	2600	3700	163.65	5.69	3.5	182.9	3.1	107	158	185	2	8.4	5.02	5219		
	170	55.6	2.1	5219A	—	—	—	—	5219AN	5219ANR	139000	131000	2400	3200	163.65	5.69	3.5	182.9	3.1	107	158	185	2	8.4	5.02	5219A		
100	180	60.3	2.1	5220	—	—	—	—	5220N	5220NR	168000	159000	2400	3200	173.66	5.69	3.5	192.9	3.1	112	168	195	2	8.4	5.78	5220		
	180	60.3	2.1	5220A	—	—	—	—	5220AN	5220ANR	158000	150000	2200	3000	173.66	5.69	3.5	192.9	3.1	112	168	195	2	8.4	5.78	5220A		

Remark: Dimensions and tolerances of snap ring groove and snap ring are shown on pages 45 to 48.



Self-aligning Ball Bearings

Tolerance	Page 52
Internal clearance	Page 64
Adapter sleeves	Page 592
Withdrawal sleeves	Page 592

● **Design**

Self-aligning Ball Bearings are particularly suitable for applications where misalignment occurs from errors in mounting or from shaft deflection.

For applications where the bearing load (particularly axial load) carrying capacity is insufficient, spherical roller bearings, which have the same self-aligning property, should be used instead.

● **Cage**

Bearings are fitted with pressed steel cage or polyamide cage.

The suffix G of bearing number on the packing surface indicate polyamide cage.

● **Attention**

- (1) Maximum permissible misalignment angle θ is about 2.5° in the 11 and 22 series, and about 3° in the 13 and 23 series under general service conditions. Care must be taken to provide sufficient clearance between the bearing and surrounding structure when bearing is operating in the full misaligned condition.
- (2) Misaligned bearings will have a tendency to become noisy as speed increases. Due to noise-level constraints, the practical maximum misalignment may be considerably less than the maximum misalignment.
- (3) The dimension tables show the width of the ball assembly as dimension B1 for larger bore sizes of Self-aligning Ball Bearings where width of the ball assembly extends beyond the ring width envelope.
- (4) It is difficult to correctly measure the running clearance of bearings with tapered bore after mounting. Mounting of this type of bearing with tapered bores requires some experience and technique.
- (5) The bearings with polyamide cage should be used at less than 120°C operating temperature.

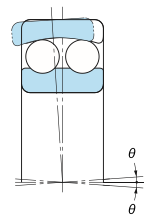

● Mounting bearings with tapered bore

Mounting bearings with a tapered bore requires some experience and technique. Bearings with tapered bore are always mounted with an interference fit on the shaft.

To measure the amount of interference fit on the shaft, the axial displacement of the inner ring or

the reduction of radial internal clearance due to the interference fit can be used. Generally, the measurement of reduction in radial internal clearance is a more reliable method than measurement of the axial displacement of the inner ring.

Table 1. Mounting self-aligning ball bearings with tapered bore

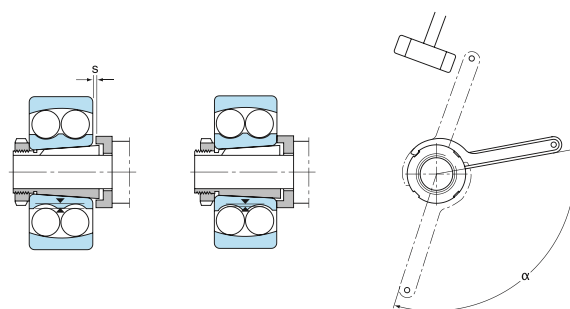

Bearing Bore Diameter d (mm)	Tightening Angle α (degree)	Axial displacement s (mm)				Mean residual clearance after mounting bearings with initial clearance	
		Bearings series				Normal (μm)	C3 (μm)
		12K	13K	22K	23K		
20	70	0.22	0.23	—	—	10	20
25	70	0.22	0.23	0.22	0.23	10	20
30	70	0.22	0.23	0.22	0.23	10	20
35	70	0.30	0.30	0.30	0.30	10	20
40	70	0.30	0.30	0.30	0.30	10	20
45	70	0.31	0.34	0.31	0.33	15	25
50	70	0.31	0.34	0.31	0.33	15	25
55	90	0.40	0.41	0.39	0.40	15	30
60	90	0.40	0.41	0.39	0.40	15	30
65	90	0.40	0.41	0.39	0.40	15	30
75	120	0.45	0.47	0.43	0.46	20	40
80	120	0.45	0.47	0.43	0.46	20	40
85	120	0.58	0.60	0.54	0.59	20	40
90	120	0.58	0.60	0.54	0.59	20	40
95	120	0.58	0.60	0.54	0.59	20	40
100	120	0.58	0.60	0.54	0.59	20	40
105	120	0.67	—	0.66	—	25	55
110	120	0.67	0.70	0.66	0.69	25	55
120	120	0.67	—	—	—	25	55

Self-aligning Ball Bearings

Bore Diameter: 10~40mm

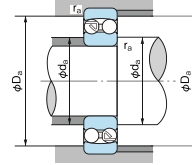
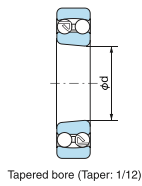
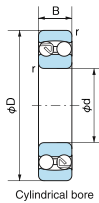

■ Dynamic equivalent radial load
Fr = XFr + YFa

Fr ≤ e		Fr > e	
X	Y	X	Y
1	Y ₁	0.65	Y ₂

■ Static equivalent radial load
Por = Fr + Y₀Fa

Values of e, Y₁, Y₂ and Y₀ from table.

1N=0.102kgf

Boundary dimensions (mm)					Bearing No.		Basic dynamic load rating Cr (N)	Basic static load rating Cor (N)	Limiting speed (min ⁻¹)		Axial load factor			Constant e	Abutment and fillet dimensions (mm)			Mass (kg) (Reference) Cylindrical bore	Bearing No.
d	D	B	B ₁	r (min)	Cylindrical bore	Tapered bore			Grease lubrication	Oil lubrication	Y ₁	Y ₂	Y ₀		d _a (min)	D _a (max)	r _a (max)		
10	30	9	—	0.6	1200	—	5500	1200	23000	28000	1.92	2.97	2.01	0.33	14	26	0.6	0.034	1200
	30	14	—	0.6	2200	—	7400	1600	23000	29000	1.07	1.65	1.12	0.59	14	26	0.6	0.047	2200
12	32	10	—	0.6	1201	—	5600	1250	21000	26000	1.89	2.93	1.98	0.33	16	28	0.6	0.040	1201
	32	14	—	0.6	2201	—	7650	1750	21000	26000	1.18	1.83	1.24	0.53	16	28	0.6	0.053	2201
	37	12	—	1	1301	—	9400	2150	18000	22000	1.77	2.74	1.86	0.36	17	32	1.0	0.067	1301
	37	17	—	1	2301	—	9700	2300	16000	22000	1.17	1.81	1.23	0.54	17	32	1.0	0.095	2301
15	35	11	—	0.6	1202	—	7450	1750	18000	22000	1.90	2.95	2.00	0.33	19	31	0.6	0.049	1202
	35	14	—	0.6	2202	—	7700	1850	18000	22000	1.27	1.97	1.33	0.50	19	31	0.6	0.060	2202
	42	13	—	1	1302	—	9550	2300	16000	20000	1.86	2.88	1.95	0.34	20	37	1.0	0.094	1302
	42	17	—	1	2302	—	12100	2900	14000	20000	1.27	1.96	1.33	0.50	20	37	1.0	0.114	2302
17	40	12	—	0.6	1203	—	7900	2000	16000	20000	2.03	3.14	2.12	0.31	21	36	0.6	0.073	1203
	40	16	—	0.6	2203	—	9800	2400	16000	20000	1.27	1.96	1.33	0.50	21	36	0.6	0.088	2203
	47	14	—	1	1303	—	12500	3200	14000	17000	1.92	2.97	2.01	0.33	22	42	1.0	0.130	1303
	47	19	—	1	2303	—	14500	3600	13000	18000	1.28	1.98	1.34	0.49	22	42	1.0	0.158	2303
20	47	14	—	1	1204	1204K	9900	2600	14000	17000	2.16	3.35	2.27	0.29	25	42	1.0	0.120	1204
	47	18	—	1	2204	2204K	12600	3300	14000	17000	1.31	2.02	1.37	0.48	25	42	1.0	0.140	2204
	52	15	—	1.1	1304	1304K	12400	3300	13000	15000	2.12	3.28	2.22	0.30	26.5	45.5	1.0	0.163	1304
	52	21	—	1.1	2304	2304K	18000	4700	11000	15000	1.29	2.00	1.35	0.49	26.5	45.5	1.0	0.209	2304
25	52	15	—	1	1205	1205K	12100	3300	12000	14000	2.28	3.52	2.39	0.28	30	47	1.0	0.141	1205
	52	18	—	1	2205	2205K	12600	3500	12000	15000	1.58	2.45	1.66	0.40	30	47	1.0	0.163	2205
	62	17	—	1.1	1305	1305K	18000	5000	9900	12000	2.31	3.57	2.42	0.27	31.5	55.5	1.0	0.257	1305
	62	24	—	1.1	2305	2305K	24400	6600	9400	13000	1.36	2.10	1.42	0.46	31.5	55.5	1.0	0.335	2305
30	62	16	—	1	1206	1206K	15600	4650	9900	12000	2.55	3.94	2.67	0.25	35	57	1.0	0.220	1206
	62	20	—	1	2206	2206K	15600	4650	10000	12000	1.79	2.77	1.87	0.35	35	57	1.0	0.260	2206
	72	19	—	1.1	1306	1306K	21300	6300	8700	11000	2.40	3.72	2.52	0.26	36.5	65.5	1.0	0.387	1306
	72	27	—	1.1	2306	2306K	31400	8750	8000	11000	1.44	2.23	1.51	0.44	36.5	65.5	1.0	0.500	2306
35	72	17	—	1.1	1207	1207K	15800	5100	8500	10000	2.71	4.20	2.84	0.23	41.5	65.5	1.0	0.323	1207
	72	23	—	1.1	2207	2207K	21600	6600	8500	10000	1.71	2.65	1.79	0.37	41.5	65.5	1.0	0.403	2207
	80	21	—	1.5	1307	1307K	25100	7850	7600	9300	2.48	3.84	2.60	0.25	43	72	1.5	0.510	1307
	80	31	—	1.5	2307	2307K	39400	11300	7100	9800	1.39	2.15	1.46	0.45	43	72	1.5	0.675	2307
40	80	18	—	1.1	1208	1208K	19200	6500	7500	9200	2.83	4.38	2.97	0.22	46.5	73.5	1.0	0.417	1208
	80	23	—	1.1	2208	2208K	22400	7400	7600	9300	1.92	2.96	2.01	0.33	46.5	73.5	1.0	0.505	2208
	90	23	—	1.5	1308	1308K	29500	9700	6900	8400	2.57	3.98	2.69	0.25	48	82	1.5	0.715	1308
	90	33	—	1.5	2308	2308K	44900	13500	6200	8600	1.47	2.27	1.54	0.43	48	82	1.5	0.925	2308

Remarks: 1. Suffix K means with a tapered bore (1/12)
2. Dimension B₁ is the width of the ball assembly extends beyond the ring width dimension.

Self-aligning Ball Bearings

Bore Diameter: 45~80mm

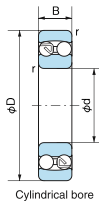

Cylindrical bore

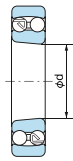

Tapered bore (Taper: 1/12)

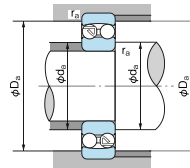

Dynamic equivalent radial load
Fr = XFr + YFa

Fr ≤ e		Fr > e	
X	Y	X	Y
1	Y ₁	0.65	Y ₂

Static equivalent radial load
Fa = Fr + Y₀Fa

Values of e, Y₁, Y₂ and Y₀ from table.

1N=0.102kgf

Boundary dimensions (mm)					Bearing No.		Basic dynamic load rating Cr (N)	Basic static load rating Cor (N)	Limiting speed (min ⁻¹)		Axial load factor			Constant e	Abutment and fillet dimensions (mm)			Mass (kg) (Reference) Cylindrical bore	Bearing No.
d	D	B	B ₁	r (min)	Cylindrical bore	Tapered bore			Grease lubrication	Oil lubrication	Y ₁	Y ₂	Y ₀		d _a (min)	D _a (max)	r _a (max)		
45	85	19	—	1.1	1209	1209K	21800	7350	7000	8500	2.94	4.56	3.09	0.21	51.5	78.5	1.0	0.465	1209
	85	23	—	1.1	2209	2209K	23300	8150	7000	8500	2.09	3.23	2.19	0.30	51.5	78.5	1.0	0.545	2209
	100	25	—	1.5	1309	1309K	38100	12700	6100	7500	2.56	3.95	2.68	0.25	53	92	1.5	0.957	1309
	100	36	—	1.5	2309	2309K	54400	16700	5600	7700	1.51	2.33	1.58	0.42	53	92	1.5	1.23	2309
50	90	20	—	1.1	1210	1210K	22700	8100	6500	7900	3.07	4.76	3.22	0.21	56.5	83.5	1.0	0.525	1210
	90	23	—	1.1	2210	2210K	23300	8500	6500	7900	2.33	3.61	2.45	0.27	56.5	83.5	1.0	0.590	2210
	110	27	—	2	1310	1310K	43400	14100	5600	6800	2.70	4.17	2.83	0.23	59	101	2.0	1.21	1310
	110	40	—	2	2310	2310K	64600	20300	5100	7000	1.56	2.41	1.63	0.40	59	101	2.0	1.64	2310
55	100	21	—	1.5	1211	1211K	26800	10000	5800	7100	3.19	4.94	3.34	0.20	63	92	1.5	0.705	1211
	100	25	—	1.5	2211	2211K	26800	10000	5800	7100	2.35	3.64	2.47	0.27	63	92	1.5	0.810	2211
	120	29	—	2	1311	1311K	51300	17900	5000	6200	2.70	4.18	2.83	0.23	64	111	2.0	1.58	1311
	120	43	—	2	2311	2311K	75300	24000	4600	6400	1.53	2.37	1.60	0.41	64	111	2.0	2.10	2311
60	110	22	—	1.5	1212	1212K	30200	11500	5200	6400	3.37	5.22	3.53	0.19	68	102	1.5	0.900	1212
	110	28	—	1.5	2212	2212K	34100	12600	5300	6500	2.26	3.49	2.36	0.28	68	102	1.5	1.09	2212
	130	31	—	2.1	1312	1312K	57200	20800	4500	5500	2.91	4.50	3.05	0.22	71	119	2.0	1.96	1312
	130	46	—	2.1	2312	2312K	87200	28300	4200	5800	1.62	2.51	1.70	0.39	71	119	2.0	2.60	2312
65	120	23	—	1.5	1213	1213K	31000	12500	4800	5800	3.67	5.68	3.84	0.17	73	112	1.5	1.15	1213
	120	31	—	1.5	2213	2213K	43500	16400	4900	5900	2.24	3.47	2.35	0.28	73	112	1.5	1.46	2213
	140	33	—	2.1	1313	1313K	61700	22900	4300	5200	2.73	4.23	2.86	0.23	76	129	2.0	2.45	1313
	140	48	—	2.1	2313	2313K	95800	32500	3800	5300	1.66	2.58	1.74	0.38	76	129	2.0	3.23	2313
70	125	24	—	1.5	1214	—	34600	13800	4600	5700	3.48	5.38	3.64	0.18	78	117	1.5	1.26	1214
	125	31	—	1.5	2214	—	43900	17100	4600	5600	2.42	3.74	2.53	0.26	78	117	1.5	1.52	2214
	150	35	—	2.1	1314	—	74000	27700	4000	4900	2.84	4.40	2.98	0.22	81	139	2.0	2.99	1314
	150	51	—	2.1	2314	—	89600	31700	3600	4900	1.82	2.82	1.91	0.35	81	139	2.0	4.23	2314
75	130	25	—	1.5	1215	1215K	38800	15700	4300	5300	3.60	5.58	3.77	0.17	83	122	1.5	1.36	1215
	130	31	—	1.5	2215	2215K	44200	17800	4300	5300	2.49	3.85	2.61	0.25	83	122	1.5	1.62	2215
	160	37	—	2.1	1315	1315K	78900	29900	4000	4900	2.80	4.33	2.93	0.23	86	149	2.0	3.56	1315
	160	55	—	2.1	2315	2315K	103000	36800	3400	4600	1.86	2.88	1.95	0.34	86	149	2.0	5.13	2315
80	140	26	—	2	1216	1216K	39800	17000	4000	4900	3.90	6.03	4.08	0.16	89	131	2.0	1.67	1216
	140	33	—	2	2216	2216K	49000	19900	4100	5000	2.42	3.75	2.54	0.26	89	131	2.0	2.01	2216
	170	39	—	2.1	1316	1316K	88100	33100	3500	4300	2.90	4.49	3.04	0.22	91	159	2.0	4.18	1316
	170	58	—	2.1	2316	2316K	129000	45700	3100	4300	1.87	2.90	1.96	0.34	91	159	2.0	6.10	2316

Remarks: 1. Suffix K means with a tapered bore (1/12)
2. Dimension B₁ is the width of the ball assembly extends beyond the ring width dimension.

Self-aligning Ball Bearings

Bore Diameter: 85~110mm

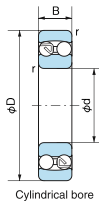

Cylindrical bore

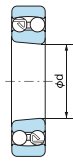

Tapered bore (Taper: 1/12)

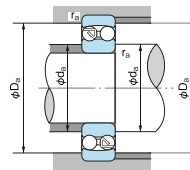

■ Dynamic equivalent radial load
 $F_r = XFr + YFa$

$\frac{F_a}{F_r} \leq e$		$\frac{F_a}{F_r} > e$	
X	Y	X	Y
1	Y ₁	0.65	Y ₂

■ Static equivalent radial load
 $P_0 = Fr + Y_0 Fa$

Values of e, Y₁, Y₂ and Y₀ from table.

1N=0.102kgf

Boundary dimensions (mm)					Bearing No.		Basic dynamic load rating Cr (N)	Basic static load rating Cor (N)	Limiting speed (min ⁻¹)		Axial load factor			Constant e	Abutment and fillet dimensions (mm)			Mass (kg) (Reference) Cylindrical bore	Bearing No.
d	D	B	B ₁	r (min)	Cylindrical bore	Tapered bore			Grease lubrication	Oil lubrication	Y ₁	Y ₂	Y ₀		d _a (min)	D _a (max)	r _a (max)		
85	150	28	—	2	1217	1217K	49200	20800	3800	4600	3.61	5.59	3.78	0.17	94	141	2	2.07	1217
	150	36	—	2	2217	2217K	58300	23600	3800	4600	2.49	3.85	2.61	0.25	94	141	2	2.52	2217
	180	41	—	3	1317	1317K	97300	37800	3300	4000	2.93	4.53	3.07	0.22	98	167	2.5	4.98	1317
	180	60	—	3	2317	2317K	141000	51500	3000	4100	1.82	2.82	1.91	0.35	98	167	2.5	7.05	2317
90	160	30	—	2	1218	1218K	56800	23400	3500	4300	3.69	5.70	3.86	0.17	99	151	2	2.52	1218
	160	40	—	2	2218	2218K	67700	27200	3500	4300	2.39	3.71	2.51	0.26	99	151	2	3.40	2218
	190	43	—	3	1318	1318K	116000	44400	3100	3800	2.81	4.35	2.94	0.22	103	177	2.5	5.80	1318
	190	64	—	3	2318	2318K	153000	57900	2800	3900	1.84	2.85	1.93	0.34	103	177	2.5	8.44	2318
95	170	32	—	2.1	1219	1219K	57000	24300	3300	4000	3.63	5.62	3.80	0.17	106	159	2	3.10	1219
	170	43	—	2.1	2219	2219K	82700	34300	3300	4000	2.43	3.76	2.55	0.26	106	159	2	4.10	2219
	200	45	48.2	3	1319	1319K	132000	50800	2900	3600	2.73	4.23	2.86	0.23	108	187	2.5	6.69	1319
	200	67	—	3	2319	2319K	166000	64800	2700	3700	1.82	2.82	1.91	0.35	108	187	2.5	9.79	2319
100	180	34	—	2.1	1220	1220K	69000	29700	3100	3800	3.62	5.60	3.79	0.17	111	169	2	3.70	1220
	180	46	—	2.1	2220	2220K	80900	34000	3100	3800	2.57	3.98	2.70	0.24	111	169	2	4.98	2220
	215	47	52	3	1320	1320K	143000	57300	2800	3400	2.66	4.11	2.78	0.24	113	202	2.5	8.30	1320
	215	73	—	3	2320	2320K	183000	73400	2400	3400	1.84	2.85	1.93	0.34	113	202	2.5	12.4	2320
105	190	36	—	2.1	1221	—	77000	34000	2900	3600	3.56	5.51	3.73	0.18	116	179	2	4.37	1221
	190	50	—	2.1	2221	—	94900	40100	3000	3600	2.43	3.76	2.55	0.26	116	179	2	6.07	2221
	225	49	54	3	1321	—	149000	60200	2600	3200	2.73	4.22	2.86	0.23	118	212	2.5	10.0	1321
	225	77	—	3	2321	—	187000	78000	2300	3200	1.75	2.71	1.83	0.36	118	212	2.5	14.3	2321
110	200	38	—	2.1	1222	1222K	80200	35200	2800	3400	3.64	5.63	3.81	0.17	121	189	2	5.15	1222
	200	53	—	2.1	2222	2222K	120000	48900	2800	3400	2.41	3.73	2.53	0.26	121	189	2	7.10	2222
	240	50	55.2	3	1322	1322K	150000	63200	2400	3000	2.82	4.37	2.96	0.22	123	227	2.5	11.8	1322
	240	80	—	3	2322	2322K	200000	85700	2200	3000	1.82	2.82	1.91	0.35	123	227	2.5	17.3	2322

Remarks: 1. Suffix K means with a tapered bore (1/12)
 2. Dimension B1 is the width of the ball assembly extends beyond the ring width dimension.



Cylindrical Roller Bearings

Tolerance Page 52
 Internal clearance Page 64
 Axial load capacity Page 34

● Designs and Configurations

NACHI Cylindrical Roller Bearings are produced in a wide variety of designs and configurations.

● Conventional Design

Cylindrical Roller Bearings of conventional design are available in 10 configurations as shown in Fig. 1. Configurations N, NU, NN and NNU will not sustain axial loading. These configurations must be used as the float end bearing.

Configurations NF, NJ, NUH are designed with the capability of sustaining axial loading in one direction. Configuration NUH is basically an NU

bearing with an addition of a guide ring (an "L" ring).

The NUH dimensional data is the same as the NH bearing configuration.

Configuration NF, NJ, and NUH can sustain axial loading in one direction.

Configuration NH, NP, and NUP have bi-directional thrust load-carrying-capability.

- The suffix of the bearing number indicates:
 E: high capacity
 G: polyamide cage

- The bearing with polyamide cage should be used at less than 120°C operating temperature.

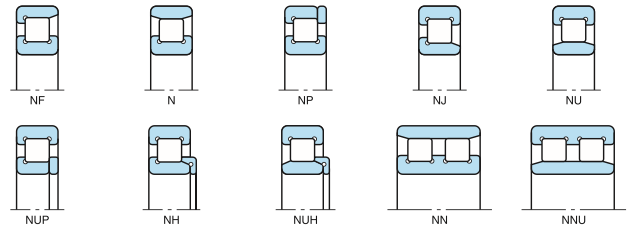

Fig 1. Cylindrical Roller Bearing Configurations

Table 1. Cylindrical Roller Bearing Standard Cage

Bearing series	Pressed Steel	Machined Brass
NU10	1007~1038	1040~10/500
NU2	203~ 228	230~ 264
NU22	2204~2226	2228~2252
NU3	304~ 324	326~ 352
NU23	2304~2319	2320~2340
NU4	405~ 416	417~ 430

● **Interchangeable Bearings**

Interchangeable cylindrical roller bearing means that a separable ring can be replaced by another ring of the bearing with the same bearing number without impairing the function of the bearing.

Table 2. Interchangeable Cylindrical Roller Bearings: Tolerance of Inscribed (Fw) and Circumscribed (Ew) Diameters

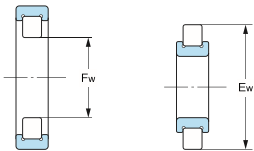

Unit: μm

Nominal bore dia. d (mm)		Tolerance of Fw		Tolerance of Ew	
Over	Incl.	High	Low	High	Low
—	20	+10	0	0	-10
20	50	+15	0	0	-15
50	120	+20	0	0	-20
120	200	+25	0	0	-25
200	250	+30	0	0	-30
250	315	+35	0	0	-35
315	400	+40	0	0	-40
400	500	+45	0	—	—

● **Radial Internal Clearance**

The initial radial internal clearance of the bearing should be determined for optimal bearing operation.

The following procedure should be observed to determine the proper initial radial internal clearance:

- Place the bearing in an upright position with inner/outer ring faces parallel.
- Place thumbs on inner ring bore and oscillate inner ring two or three times, pressing down firmly. This "seats" the inner ring and rollers.
- Position the individual roller assemblies so that a roller is at the top of inner ring - on both sides of the bearing.
- Press the two rollers inward to assure contact with the center guide ring as well as the inner ring raceway.
- With the rollers in correct position, insert a thin feeler gauge between the rollers and the raceway. **Caution : DO NOT ROLL THE BEARING.**
- Move it carefully over the top roller between the roller and outer raceway.
- Repeat this procedure, using progressively thicker feeler gauge until one is found that will not go through.
- The gauge thickness that preceded the "No - GO" gauge is the radial internal clearance.

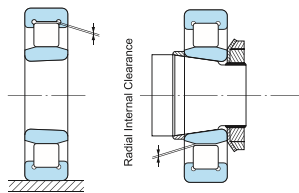
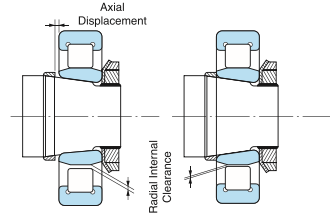

Table 3. Mounting cylindrical roller bearings with tapered bore



Unit: μm

Bearing Bore Diameter d (mm)		Radial Clearance Reduction (mm)		Axial displacement Taper 1:12			
				Direct Mounting on the shaft (mm)		With Adapter Assemblies (mm)	
Over	Incl.	min	max	min	max	max	min
40	50	0.025	0.030	0.40	0.50	0.55	0.60
50	65	0.030	0.035	0.50	0.55	0.60	0.70
65	80	0.030	0.040	0.50	0.65	0.60	0.75
80	100	0.035	0.045	0.55	0.70	0.70	0.85
100	120	0.040	0.050	0.65	0.80	0.75	0.90
120	140	0.045	0.055	0.70	0.85	0.85	1.00
140	160	0.045	0.060	0.70	0.95	0.85	1.05
160	180	0.050	0.065	0.80	1.00	0.90	1.15
180	200	0.055	0.070	0.85	1.10	1.00	1.20
200	225	0.065	0.080	1.00	1.25	1.15	1.35
225	250	0.070	0.085	1.10	1.30	1.20	1.45
250	280	0.075	0.095	1.15	1.45	1.30	1.60
280	315	0.080	0.100	1.25	1.55	1.35	1.65
315	355	0.095	0.115	1.45	1.75	1.60	1.90
355	400	0.100	0.125	1.55	1.90	1.65	2.05
400	450	0.115	0.140	1.80	2.20	1.90	2.30
450	500	0.130	0.160	2.00	2.50	2.10	2.60

Note: 1. The axial displacement values are applied for mounting on a solid shaft. In case of a hollow shaft, larger axial displacement should be applied.
 2. It is imperative to check radial internal clearance after mounting when ;
 - The initial unmounted radial internal clearance is in the lower half of the tolerance range.
 - There is a temperature difference between the inner and outer rings under operating conditions.
 Internal clearance after mounting must be above the values shown in the table.

Cylindrical Roller Bearings

Bore Diameter: 50~60mm

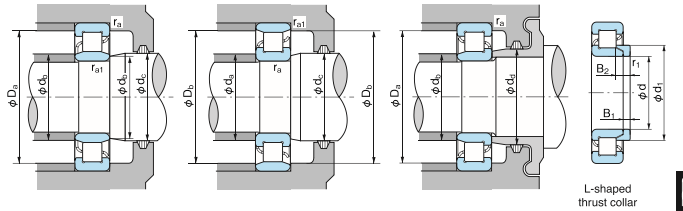
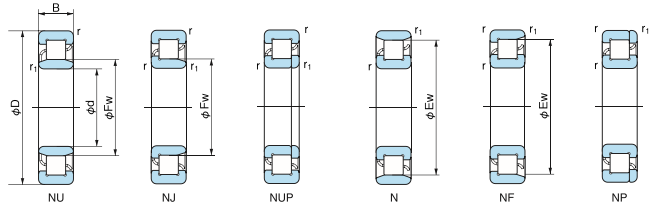

1N=0.102kgf

Table with columns for Boundary dimensions (mm), Bearing No., Basic dynamic load rating Cr (N), Basic static load rating Cor (N), Limiting speed (min⁻¹), Abutment and fillet dimensions (mm), Mass (kg), and Dimensions of L-shaped thrust collar (mm). Rows are categorized by bore diameter (50, 55, 60 mm) and include bearing models like NU 1010, NU 210, NJ 210EG, etc.

Note: (1) The dimension table shows limiting speed for bearings made with machined cages. For bearings made with pressed steel cages, multiply the table limits by 0.8.

Cylindrical Roller Bearings
Bore Diameter: 65~75mm

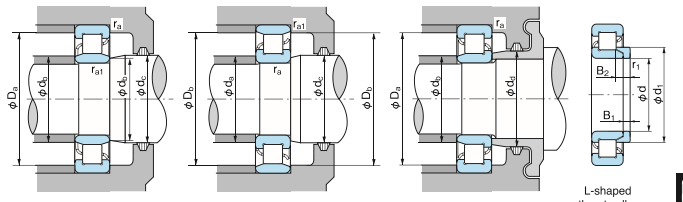
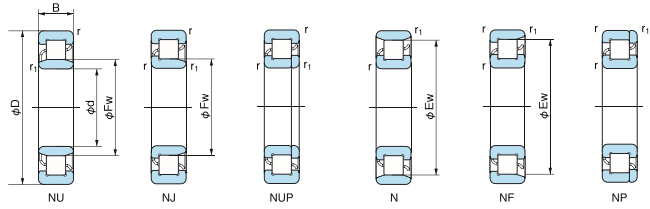

1N=0.102kgf

d	Boundary dimensions (mm)						Bearing No.						Basic dynamic load rating Cr (N)	Basic static load rating Cor (N)	Limiting speed (min ⁻¹) ⁽¹⁾	Abutment and fillet dimensions (mm)						Mass (kg)		Dimensions of L-shaped thrust collar (mm)															
	D	B	Ew	Fw	r (min)	r1 (min)	NU	NJ	NUP	N	NF	NP				da (min)	db (min)	dc (min)	dd (min)	Da (max)	Dh (max)	fa (max)	ra1 (max)	NU	N	Bearing No.	d	d1 (max)	B1	B2	r1 (min)	Mass (kg) Reference							
65	100	18	90.5	74.5	1.1	1	NU 1013	-	-	N	-	-	41000	51000	6300	8000	-	-	-	-	-	-	-	-	-	-	-	-	-	-	-	-	-	-	-	-	-	-	-
	120	23	105.6	79.6	1.5	1.5	NU 213	NJ	NUP	N	NF	NP	84000	94500	5300	6300	71.5	71	73	75	-	93	95	91.5	1	1	0.514	0.560	-	-	-	-	-	-	-	-	-	-	
	120	23	-	78.5	1.5	1.5	NU 213 E	NJ	NUP	-	-	-	108000	119000	4800	5600	-	-	-	-	-	1.5	1.5	1.06	1.04	-	-	-	HJ 213	65	84.8	6	11	1.5	0.127				
	120	31	-	78.6	1.5	1.5	NU 2213	NJ	NUP	-	-	-	120000	149000	4800	6000	-	-	-	-	-	1.5	1.5	1.43	-	-	-	-	HJ 2213	65	84.8	6	11.5	1.5	0.130				
	120	31	-	78.5	1.5	1.5	NU 2213 E	NJ	NUP	-	-	-	149000	181000	4800	6000	-	-	-	-	-	1.5	1.5	1.65	-	-	-	-	HJ 2213 E	65	84.5	6	10.5	1.5	0.126				
	140	33	121.5	83.5	2.1	2.1	NU 313	NJ	NUP	N	NF	NP	135000	139000	4500	5300	77	77	81	85	93	128	128	125	2	2	2.27	2.22	HJ 313	65	91	10	17	2.1	0.286				
	140	33	-	82.5	2.1	2.1	NU 313 E	NJ	NUP	-	-	-	181000	191000	4000	4800	-	-	-	-	-	2	2	2.55	-	-	-	-	HJ 313 E	65	90.6	10	15.5	2.1	0.274				
	140	48	-	83.5	2.1	2.1	NU 2313	NJ	NUP	-	-	-	188000	212000	4000	4800	-	-	-	-	-	2	2	3.25	-	-	-	-	HJ 2313	65	91	10	20	2.1	0.309				
	140	48	-	82.5	2.1	2.1	NU 2313 E	NJ	NUP	-	-	-	247000	287000	3800	4800	-	-	-	-	-	2	2	3.56	-	-	-	-	HJ 2313 E	65	90.6	10	18	2.1	0.309				
	160	37	135.3	89.3	2.1	2.1	NU 413	NJ	NUP	N	NF	NP	195000	203000	4000	4800	77	77	88	91	100	148	148	137	2	2	3.68	3.58	HJ 413	65	98.5	11	18	2.1	0.417				
70	110	20	100	80	1.1	1	NU 1014	-	-	N	-	-	58500	70500	6000	7100	76.5	76	78	82	-	103	105	100.5	1	1	0.712	0.702	-	-	-	-	-	-	-	-	-	-	
	125	24	110.5	84.5	1.5	1.5	NU 214	NJ	NUP	N	NF	NP	83500	95000	5000	6300	78.5	78.5	82	86	92	116.5	116.5	114	1.5	1.5	1.16	1.14	HJ 214	70	89.6	7	12.5	1.5	0.154				
	125	24	-	83.5	1.5	1.5	NU 214 E	NJ	NUP	-	-	-	119000	137000	4600	5600	-	-	-	-	-	1.5	1.5	1.26	-	-	-	-	HJ 214 E	70	89.5	7	11	1.5	0.149				
	125	31	-	84.5	1.5	1.5	NU 2214	NJ	NUP	-	-	-	119000	151000	4800	5600	-	-	-	-	-	1.5	1.5	1.52	-	-	-	-	HJ 2214	70	89.6	7	12.5	1.5	0.154				
	125	31	-	83.5	1.5	1.5	NU 2214 E	NJ	NUP	-	-	-	156000	194000	4600	5600	-	-	-	-	-	1.5	1.5	1.68	-	-	-	-	HJ 2214 E	70	89.5	7	11.5	1.5	0.152				
	150	35	130	90	2.1	2.1	NU 314	NJ	NUP	N	NF	NP	158000	220000	4000	5000	82	82	87	92	100	138	138	134	2	2	2.73	2.68	HJ 314	70	98	10	17.5	2.1	0.336				
	150	35	-	89	2.1	2.1	NU 314 E	NJ	NUP	-	-	-	205000	222000	3600	4300	-	-	-	-	-	2	2	3.15	-	-	-	-	HJ 314 E	70	97.5	10	15.5	2.1	0.315				
	150	51	-	90	2.1	2.1	NU 2314	NJ	NUP	-	-	-	223000	262000	3800	4500	-	-	-	-	-	2	2	3.97	-	-	-	-	HJ 2314	70	98	10	20.5	2.1	0.362				
	150	51	-	89	2.1	2.1	NU 2314 E	NJ	NUP	-	-	-	274000	325000	3600	4500	-	-	-	-	-	2	2	4.30	-	-	-	-	HJ 2314 E	70	97.5	10	18.5	2.1	0.343				
	180	42	152	100	3	3	NU 414	NJ	NUP	N	NF	NP	228000	236000	3600	4300	84	84	99	102	112	166	166	153	2.5	2.5	5.40	5.26	HJ 414	70	110.5	12	20	3	0.607				
75	115	20	105	85	1.1	1	NU 1015	-	-	N	-	-	60000	74500	5600	6700	81.5	81	83	87	-	108	110	105.5	1	1	0.745	0.735	-	-	-	-	-	-	-	-	-	-	
	130	25	116.5	88.5	1.5	1.5	NU 215	NJ	NUP	N	NF	NP	96500	111000	4800	6000	83.5	83.5	87	90	96	121.5	121.5	120	1.5	1.5	1.24	1.22	HJ 215	75	94	7	12.5	1.5	0.161				
	130	25	-	88.5	1.5	1.5	NU 215 E	NJ	NUP	-	-	-	130000	156000	4300	5300	-	-	-	-	-	1.5	1.5	1.38	-	-	-	-	HJ 215 E	75	94.5	7	11	1.5	0.159				
	130	31	-	88.5	1.5	1.5	NU 2215	NJ	NUP	-	-	-	130000	162000	4500	5300	-	-	-	-	-	1.5	1.5	1.57	-	-	-	-	HJ 2215	75	94	7	12.5	1.5	0.161				
	130	31	-	88.5	1.5	1.5	NU 2215 E	NJ	NUP	-	-	-	162000	207000	4300	5300	-	-	-	-	-	1.5	1.5	1.80	-	-	-	-	HJ 2215 E	75	94.5	7	11.5	1.5	0.162				
	160	37	139.5	95.5	2.1	2.1	NU 315	NJ	NUP	N	NF	NP	190000	205000	3800	4800	87	87	93	97	106	148	148	143	2	2	3.21	3.15	HJ 315	75	104.2	11	18.5	2.1	0.406				
	160	37	-	95	2.1	2.1	NU 315 E	NJ	NUP	-	-	-	240000	263000	3400	4000	-	-	-	-	-	2	2	3.70	-	-	-	-	HJ 315 E	75	104.2	11	16.5	2.1	0.389				
	160	55	-	95.5	2.1	2.1	NU 2315	NJ	NUP	-	-	-	258000	300000	3400	4300	-	-	-	-	-	2	2	4.84	-	-	-	-	HJ 2315	75	104.2	11	21.5	2.1	0.437				
	160	55	-	95	2.1	2.1	NU 2315 E	NJ	NUP	-	-	-	330000	395000	3400	4300	-	-	-	-	-	2	2	5.30	-	-	-	-	HJ 2315 E	75	104.2	11	19.5	2.1	0.421				
	190	45	160.5	104.5	3	3	NU 415	NJ	NUP	N	NF	NP	262000	274000	3400	4000	89	89	103	107	118	176	176	162	2.5	2.5	6.40	6.25	HJ 415	75	116	13	21.5	3	0.710				

Note: (1) The dimension table shows limiting speed for bearings made with machined cages. For bearings made with pressed steel cages, multiply the table limits by 0.8.

Cylindrical Roller Bearings

Bore Diameter: 95~110mm

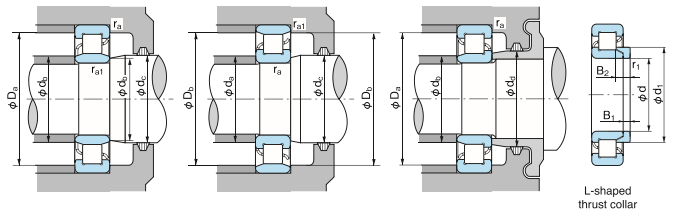
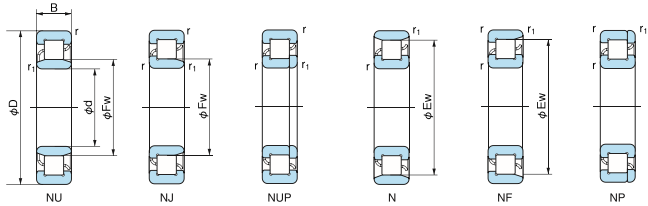

L-shaped thrust collar

1N=0.102kgf

Boundary dimensions (mm)				Bearing No.						Basic dynamic load rating Cr (N)	Basic static load rating Cor (N)	Limiting speed (min ⁻¹) ⁽¹⁾		Abutment and fillet dimensions (mm)						Mass (kg)		Dimensions of L-shaped thrust collar (mm)															
d	D	B	Ew	Fw	r (min)	r1 (min)	NU	NJ	NUP	N	NF	NP	Cr (N)	Cor (N)	Grease lubrication	Oil lubrication	da (min)	db (min)	dc (min)	dd (min)	Da (max)	Db (max)	fa (min)	ra1 (max)	NU	N	Bearing No.	d	d1 (max)	B1	B2	r1 (min)	Mass (kg) Reference				
95	145	24	132	108	1.5	1.1	NU 1019	-	-	N	-	-	90500	120000	4500	5300	-	-	-	-	-	-	-	-	-	-	-	-	-	-	-	-	-	-	-	-	-
	170	32	151.5	113.5	2.1	2.1	NU 219	NJ	NUP	N	NF	NP	165000	195000	3800	4500	107	107	111	116	123	158	158	155	2	2	2.81	2.75	HJ 219	95	121	9	15.5	2.1	0.357		
	170	32	-	112.5	2.1	2.1	NU 219E	NJ	NUP	-	-	-	222000	259000	3400	4000	-	107	111	116	123	158	-	2	2	3.08	-	HJ 219E	95	120.6	9	14	2.1	0.340			
	170	43	-	113.5	2.1	2.1	NU 2219	NJ	NUP	-	-	-	230000	298000	3400	4000	-	107	111	116	123	158	-	2	2	3.85	-	HJ 2219	95	121	9	16.5	2.1	0.367			
	170	43	-	112.5	2.1	2.1	NU 2219E	NJ	NUP	-	-	-	286000	370000	3400	4000	-	107	111	116	123	158	-	2	2	4.23	-	HJ 2219E	95	120.6	9	15.5	2.1	0.357			
	200	45	173.5	121.5	3	3	NU 319	NJ	NUP	N	NF	NP	259000	289000	3000	3600	109	109	119	124	134	186	186	178	2.5	2.5	6.23	6.13	HJ 319	95	132	13	22.5	3	0.774		
	200	45	-	121.5	3	3	NU 319E	NJ	NUP	-	-	-	335000	385000	2600	3200	-	109	119	124	134	186	-	2.5	2.5	6.92	-	HJ 319E	95	132.2	13	20.5	3	0.750			
	200	67	-	121.5	3	3	NU 2319	NJ	NUP	-	-	-	370000	460000	2600	3400	-	109	119	124	134	186	-	2.5	2.5	9.39	-	HJ 2319	95	132	13	26.5	3	0.836			
	200	67	-	121.5	3	3	NU 2319E	NJ	NUP	-	-	-	460000	585000	2600	3200	-	109	119	124	134	186	-	2.5	2.5	10.3	-	HJ 2319E	95	132.2	13	20.5	3	0.750			
	240	55	201.5	133.5	4	4	NU 419	NJ	NUP	N	NF	NP	400000	445000	2600	3200	113	113	132	136	149	222	222	204	3	3	14.0	13.6	HJ 419	95	147	15	25.5	4	1.32		
	150	24	137	113	1.5	1.1	NU 1020	-	-	N	-	-	93000	126000	4300	5300	108	107	111	116	-	141.5	143.5	137.5	1.5	1	1.48	1.46	-	-	-	-	-	-	-	-	
	180	34	160	120	2.1	2.1	NU 220	NJ	NUP	N	NF	NP	183000	217000	3600	4300	112	112	117	122	130	168	168	164	2	2	3.30	3.23	HJ 220	100	128	10	17	2.1	0.448		
180	34	-	119	2.1	2.1	NU 220E	NJ	NUP	-	-	-	250000	305000	3200	3800	-	112	117	122	130	168	-	2	2	3.73	-	HJ 220E	100	127.5	10	15	2.1	0.421				
180	46	-	120	2.1	2.1	NU 2220	NJ	NUP	-	-	-	257000	335000	3200	3800	-	112	117	122	130	168	-	2	2	4.67	-	HJ 2220	100	128	10	18	2.1	0.459				
180	46	-	119	2.1	2.1	NU 2220E	NJ	NUP	-	-	-	335000	445000	3200	3800	-	112	117	122	130	168	-	2	2	5.13	-	HJ 2220E	100	127.5	10	16	2.1	0.433				
215	47	185.5	129.5	3	3	NU 320	NJ	NUP	N	NF	NP	300000	335000	2800	3400	114	114	125	132	143	201	201	190	2.5	2.5	7.70	7.53	HJ 320	100	140.5	13	22.5	3	0.892			
215	47	-	127.5	3	3	NU 320E	NJ	NUP	-	-	-	380000	425000	2400	3000	-	114	125	132	143	201	-	2.5	2.5	8.45	-	HJ 320E	100	139.6	13	20.5	3	0.850				
215	73	-	129.5	3	3	NU 2320	NJ	NUP	-	-	-	435000	545000	2400	3200	-	114	125	132	143	201	-	2.5	2.5	11.9	-	HJ 2320	100	140.5	13	27.5	3	0.977				
215	73	-	127.5	3	3	NU 2320E	NJ	NUP	-	-	-	570000	715000	2400	3000	-	114	125	132	143	201	-	2.5	2.5	12.9	-	HJ 2320E	100	139.6	13	23.5	3	0.906				
250	58	211	139	4	4	NU 420	NJ	NUP	N	NF	NP	450000	500000	2600	3000	118	118	137	141	156	232	232	213	3	3	14.4	14.0	HJ 420	100	153.5	16	27	4	1.52			
160	26	145.5	119.5	2	1.1	NU 1021	-	-	N	-	-	109000	149000	4000	4800	114	112	118	122	-	150	153.5	146.5	2	1	1.88	1.85	-	-	-	-	-	-	-	-		
190	36	168.8	126.8	2.1	2.1	NU 221	NJ	NUP	N	NF	NP	202000	241000	3400	4000	117	117	124	129	137	178	178	173	2	2	4.03	3.95	HJ 221	105	135	10	17.5	2.1	0.507			
225	49	195	135	3	3	NU 321	NJ	NUP	N	NF	NP	340000	385000	2600	3200	119	119	132	137	149	211	211	199	2.5	2.5	8.73	8.51	HJ 321	105	147	13	22.5	3	0.977			
260	60	220.5	144.5	4	4	NU 421	NJ	NUP	N	NF	NP	495000	555000	2400	3000	123	123	143	147	162	242	242	223	3	3	19.5	19.1	HJ 421	105	159.5	16	27	4	1.62			
170	28	155	125	2	1.1	NU 1022	-	-	N	-	-	131000	174000	3800	4500	119	117	124	128	-	160	163.5	156	2	1	2.34	2.31	-	-	-	-	-	-	-	-		
200	38	178.5	132.5	2.1	2.1	NU 222	NJ	NUP	N	NF	NP	240000	290000	3200	3800	122	122	130	135	144	188	188	182	2	2	4.64	4.58	HJ 222	110	141.5	11	18.5	2.1	0.608			
200	38	-	132.5	2.1	2.1	NU 222E	NJ	NUP	-	-	-	293000	365000	2800	3400	-	122	130	135	144	188	-	2	2	5.17	-	HJ 222E	110	141.7	11	17	2.1	0.593				
200	53	-	132.5	2.1	2.1	NU 2222	NJ	NUP	-	-	-	320000	440000	2800	3400	-	122	130	135	144	188	-	2	2	6.93	-	HJ 2222	110	141.5	11	20.5	2.1	0.600				
200	53	-	132.5	2.1	2.1	NU 2222E	NJ	NUP	-	-	-	385000	515000	2800	3400	-	122	130	135	144	188	-	2	2	7.32	-	HJ 2222E	110	141.7	11	19.5	2.1	0.629				
240	50	207	143	3	3	NU 322	NJ	NUP	N	NF	NP	380000	435000	2600	3000	124	124	140	145	158	226	226	211	2.5	2.5	10.4	10.2	HJ 322	110	155.5	14	23	3	1.17			
240	50	-	143	3	3	NU 322E	NJ	NUP	-	-	-	450000	525000	2200	2800	-	124	140	145	158	226	-	2.5	2.5	11.1	-	HJ 322E	110	155.8	14	22	3	1.16				
240	80	-	143	3	3	NU 2322	NJ	NUP	-	-	-	570000	735000	2200	2800	-	124	140	145	158	226	-	2.5	2.5	18.8	-	HJ 2322	110	155.5	14	28	3	1.27				
240	80	-	143	3	3	NU 2322E	NJ	NUP	-	-	-	670000	880000	2200	2800	-	124	140	145	158	226	-	2.5	2.5	18.5	-	HJ 2322E	110	155.8	14	26.5	3	1.26				
280	65	235	155	4	4	NU 422	NJ	NUP	N	NF	NP	550000	620000	2200	2800	128	128	153	157	173	262	262	237	3	3	20.5	19.9	HJ 422	110	171	17	29.5	4	2.05			

Note: ⁽¹⁾ The dimension table shows limiting speed for bearings made with machined cages. For bearings made with pressed steel cages, multiply the table limits by 0.5.

Cylindrical Roller Bearings
Bore Diameter: 190~380mm

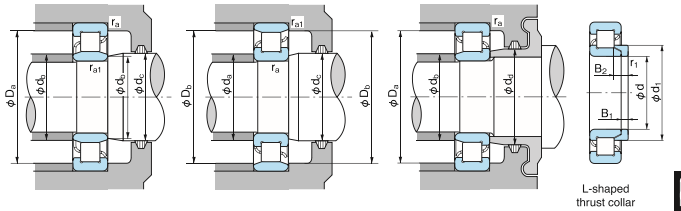
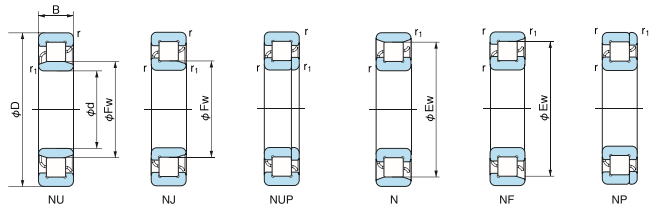

1N=0.102kgf

d	Boundary dimensions (mm)							Bearing No.							Basic dynamic load rating Cr (N)	Basic static load rating Cor (N)	Limiting speed (min ⁻¹)(¹)		Abutment and fillet dimensions (mm)								Mass (kg)		Dimensions of L-shaped thrust collar (mm)								
	D	B	EW	Fw	r (min)	r1 (min)	NU	NJ	NUP	N	NF	NP	load rating Cr (N)	rating Cor (N)			Grease lubrication	Oil lubrication	da (min)	db (min)	dc (min)	dd (min)	Da (max)	Db (max)	ra (min)	ra1 (max)	NU	N	Bearing No.	d	d1 (max)	B1	B2	r1 (min)	Mass (kg) Reference		
	(mm)	(mm)	(mm)	(mm)	(mm)	(mm)																															
190	290	46	265	215	2.1	2.1	NU 1038	—	—	N	—	—	365000	535000	2000	2600	—	—	—	—	278	279	266	2	2	11.2	10.9	—	—	—	—	—	—	—	—	—	—
340	55	299	231	4	4	4	NU 238	NJ	NUP	N	NF	NP	555000	770000	1800	2200	—	—	—	—	322	322	311	3	3	22.6	22.1	HJ 238	190	244.5	13	23.5	4	2.16			
340	55	—	230	4	4	—	NU 238 E	NJ	NUP	—	—	—	695000	955000	1700	2000	—	—	—	—	322	—	3	3	26.0	—	HJ 238 E	190	244.5	13	21.5	4	2.11				
340	92	—	231	4	4	—	NU 2238	NJ	NUP	—	—	—	830000	1290000	1600	2000	—	—	—	—	322	—	3	3	37.5	—	HJ 2238	190	243	13	31.5	4	2.32				
340	92	—	228	4	—	—	NU 2238 E	NJ	NUP	—	—	—	1100000	1670000	1700	2000	—	—	—	—	322	—	3	3	45.2	—	HJ 2238 E	190	243.2	13	26.5	4	2.28				
400	78	345	245	5	5	—	NU 338	NJ	NUP	N	NF	NP	975000	1260000	1400	1700	—	—	—	—	378	378	349	4	4	49.4	48.3	HJ 338	190	265	18	32	5	4.36			
400	132	—	245	5	5	—	NU 2338	NJ	NUP	—	—	—	1520000	2220000	1300	1600	—	—	—	—	378	—	4	4	85.0	—	HJ 2338	190	265	18	41.5	5	4.92				
200	310	51	281	229	2.1	2.1	NU 1040	—	—	N	—	—	390000	580000	2000	2400	—	—	—	—	298	299	283	2	2	14.4	14.1	—	—	—	—	—	—	—	—		
360	58	316	244	4	4	—	NU 240	NJ	NUP	N	NF	NP	620000	865000	1500	1800	—	—	—	—	342	342	328	3	3	26.8	26.2	HJ 240	200	258	14	25	4	2.59			
360	58	—	243	4	4	—	NU 240 E	NJ	NUP	—	—	—	765000	1060000	1600	1900	—	—	—	—	342	—	3	3	29.5	—	HJ 240 E	200	258.2	14	23	4	2.54				
360	98	—	244	4	4	—	NU 2240	NJ	NUP	—	—	—	925000	1440000	1500	1800	—	—	—	—	342	—	3	3	45.4	—	HJ 2240	200	258	14	34	4	2.95				
360	98	—	241	4	4	—	NU 2240 E	NJ	NUP	—	—	—	1220000	1870000	1500	1800	—	—	—	—	342	—	3	3	52.3	—	HJ 2240 E	200	256.9	14	28	4	2.73				
420	80	360	260	5	5	—	NU 340	NJ	NUP	N	NF	NP	975000	1270000	1300	1600	—	—	—	—	398	398	364	4	4	55.8	54.5	HJ 340	200	280	18	33	5	4.91			
420	138	—	260	5	5	—	NU 2340	NJ	NUP	—	—	—	1510000	2240000	1200	1500	—	—	—	—	398	—	4	4	96.8	—	HJ 2340	200	280	18	44.5	5	5.63				
220	340	56	310	250	3	3	NU 1044	—	—	N	—	—	500000	750000	1800	2300	—	—	—	—	326	327	311	2.5	2.5	18.8	18.5	—	—	—	—	—	—	—	—		
400	65	350	270	4	4	—	NU 244	NJ	NUP	N	NF	NP	760000	1080000	1500	1800	—	—	—	—	382	382	362	3	3	37.8	37.0	HJ 244	220	286	15	27.5	4	3.53			
400	108	—	270	4	4	—	NU 2244	NJ	NUP	—	—	—	1140000	1810000	1400	1700	—	—	—	—	382	—	3	3	61.8	—	HJ 2244	220	286	15	36.5	4	3.99				
460	88	396	284	5	5	—	NU 344	NJ	NUP	N	NF	NP	1200000	1570000	1200	1500	—	—	—	—	438	438	400	4	4	73.6	71.7	HJ 344	220	307	20	36	5	6.53			
240	360	56	330	270	3	3	NU 1048	—	—	N	—	—	530000	820000	1700	2100	—	—	—	—	346	347	331	2.5	2.5	20.4	20.1	—	—	—	—	—	—	—	—		
440	72	385	295	4	4	—	NU 248	NJ	NUP	N	NF	NP	935000	1340000	1400	1600	—	—	—	—	422	422	397	3	3	51.1	50.0	HJ 248	240	313	16	29.5	4	4.57			
440	120	—	295	4	4	—	NU 2248	NJ	NUP	—	—	—	1440000	2320000	1300	1600	—	—	—	—	422	—	3	3	83.5	—	HJ 2248	240	313	16	38.5	4	5.14				
500	95	430	310	5	5	—	NU 348	NJ	NUP	N	NF	NP	1430000	1950000	1100	1300	—	—	—	—	478	478	434	4	4	93.0	90.9	HJ 348	240	335	22	39.5	5	8.55			
260	400	65	364	296	4	4	NU 1052	—	—	N	—	—	645000	1000000	1600	1800	—	—	—	—	382	382	365	3	3	29.6	29.2	—	—	—	—	—	—	—	—		
480	80	420	320	5	5	—	NU 252	NJ	NUP	N	NF	NP	1140000	1660000	1300	1500	—	—	—	—	458	458	432	4	4	69.0	66.7	HJ 252	260	340	18	33	5	6.12			
480	130	—	320	5	5	—	NU 2252	NJ	NUP	—	—	—	1780000	2930000	1100	1300	—	—	—	—	458	—	4	4	106	—	HJ 2252	260	340	18	40.5	5	6.69				
540	102	464	336	6	6	—	NU 352	NJ	NUP	N	NF	NP	1620000	2230000	1000	1200	—	—	—	—	512	512	468	5	5	117	114	HJ 352	260	362	24	43	6	8.77			
280	420	65	384	316	4	4	NU 1056	—	—	N	—	—	660000	1050000	1500	1700	—	—	—	—	402	402	385	3	3	33.0	32.5	—	—	—	—	—	—	—	—		
500	80	440	340	5	5	—	NU 256	NJ	NUP	N	NF	NP	1140000	1680000	1200	1400	—	—	—	—	478	478	452	4	4	71.5	70.0	HJ 256	280	360	18	33	5	6.52			
300	460	74	420	340	4	4	NU 1060	—	—	N	—	—	885000	1400000	1400	1500	—	—	—	—	442	442	421	3	3	44.7	44.1	—	—	—	—	—	—	—	—		
540	85	476	364	5	5	—	NU 260	NJ	NUP	N	NF	NP	1400000	2070000	1100	1300	—	—	—	—	518	518	487	4	4	88.9	87.0	HJ 260	300	387	20	34.5	5	8.33			
320	480	74	440	360	4	4	NU 1064	—	—	N	—	—	905000	1470000	1300	1400	—	—	—	—	462	462	441	3	3	49.3	48.4	—	—	—	—	—	—	—	—		
580	92	510	390	5	5	—	NU 264	NJ	NUP	N	NF	NP	1600000	2390000	1000	1200	—	—	—	—	558	558	522	4	4	113	111	HJ 264	320	415	21	37	5	10.3			
340	520	82	475	385	5	5	NU 1068	—	—	N	—	—	1080000	1740000	1200	1300	—	—	—	—	498	498	476	4	4	65.9	64.8	—	—	—	—	—	—	—	—		
360	540	82	495	405	5	5	NU 1072	—	—	N	—	—	1110000	1830000	1100	1300	—	—	—	—	498	498	476	4	4	68.8	67.7	—	—	—	—	—	—	—	—		
380	560	82	515	425	5	5	NU 1076	—	—	N	—	—	1140000	1910000	1000	1200	—	—	—	—	538	538	516	4	4	72.3	71.1	—	—	—	—	—	—	—	—		

Note: (1) The dimension table shows limiting speed for bearings made with machined cages. For bearings made with pressed steel cages, multiply the table limits by 0.8.

Cylindrical Roller Bearings

Bore Diameter: 400~500mm

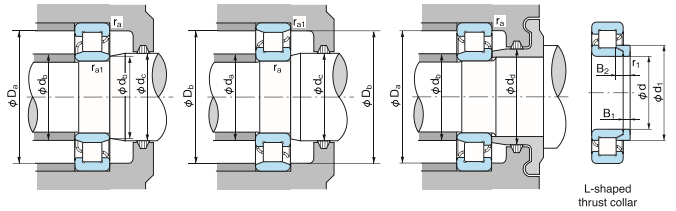
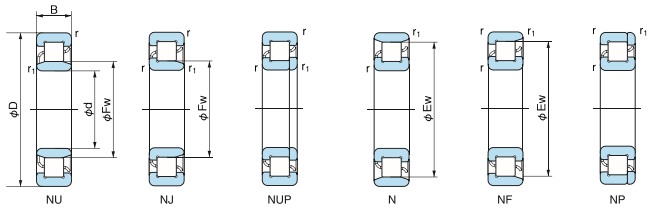

1N=0.102kgf

Boundary dimensions (mm)							Bearing No.						Basic dynamic load rating Cr (N)	Basic static load rating Cor (N)	Limiting speed (min ⁻¹) ⁽¹⁾		Abutment and fillet dimensions (mm)						Mass (kg)		Dimensions of L-shaped thrust collar (mm)										
d	D	B	Ew	Fw	r (min)	r1 (min)	NU	NJ	NUP	N	NF	NP			Grease lubrication	Oil lubrication	da (min)	db (min)	dc (max)	dd (min)	Da (max)	Dh (max)	fa (min)	ra1 (max)	NU	N	Bearing No.	d	d1 (max)	B1	B2	r1 (min)	Mass (kg) Reference		
400	600	90	550	450	5	5	NU 1080	-	-	N	-	-	1360000	2280000	950	1100	422	422	446	455	-	578	578	551	4	4	92.5	92.4	-	-	-	-	-	-	-
420	620	90	570	470	5	5	NU 1084	-	-	N	-	-	1390000	2380000	900	1100	442	442	466	475	-	598	598	571	4	4	97.6	95.8	-	-	-	-	-	-	-
440	650	94	597	493	6	6	NU 1088	-	-	N	-	-	1530000	2530000	850	1050	468	468	489	498	-	622	622	598	5	5	112	110	-	-	-	-	-	-	-
460	680	100	624	516	6	6	NU 1092	-	-	N	-	-	1630000	2740000	800	1000	488	488	512	520	-	652	652	625	5	5	130	128	-	-	-	-	-	-	-
480	700	100	644	536	6	6	NU 1096	-	-	N	-	-	1620000	2860000	780	950	508	508	532	541	-	672	672	645	5	5	135	132	-	-	-	-	-	-	-
500	720	100	664	556	6	6	NU 10/500	-	-	N	-	-	1700000	2970000	750	900	528	528	552	561	-	692	692	665	5	5	140	137	-	-	-	-	-	-	-

Note: ⁽¹⁾ The dimension table shows limiting speed for bearings made with machined cages. For bearings made with pressed steel cages, multiply the table limits by 0.8.

Double-row Cylindrical Roller Bearings

Bore Diameter: 25~180mm

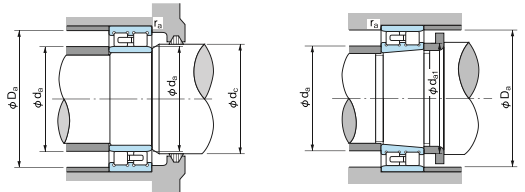
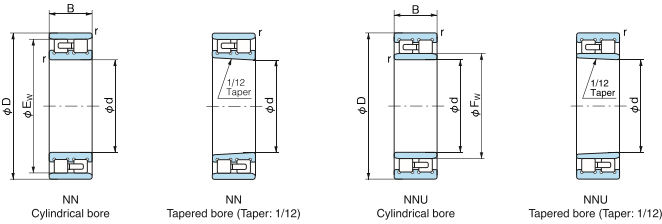

1N=0.102kgf

Boundary dimensions (mm)					Bearing No.		Basic dynamic load rating Cr (N)	Basic static load rating Cor (N)	Limiting speed (min ⁻¹)		Abutment and fillet dimensions (mm)								Mass (kg) (Reference Tapered bore)	Bearing No.
d	D	B	E _w	F _w	r (min)	Cylindrical bore			Tapered bore	Grease lubrication	Oil lubrication	d _a (min)	d _a (max)	d _{a1} (min)	d _c (min)	d _c (max)	D _a (min)	D _a (max)		
25	47	16	41.3	—	0.6	NN3005	NN3005K	25800	30000	15000	17000	30	—	30	—	42	41.8	0.6	0.123	NN3005K
	30	19	48.5	—	1	NN3006	NN3006K	31000	37000	12000	15000	36	—	37	—	49	49	1	0.199	NN3006K
	35	20	55	—	1	NN3007	NN3007K	39500	50000	11000	13000	41	—	42	—	56	56	1	0.258	NN3007K
40	68	21	61	—	1	NN3008	NN3008K	43500	55500	9800	11000	46	—	48	—	62	62	1	0.312	NN3008K
	45	23	67.5	—	1	NN3009	NN3009K	52000	68500	8800	10000	51	—	52	—	69	69	1	0.405	NN3009K
	50	23	72.5	—	1	NN3010	NN3010K	53000	72500	8200	9600	56	—	58	—	74	74	1	0.454	NN3010K
55	90	26	81	—	1.1	NN3011	NN3011K	69500	96500	7300	8600	62	—	64	—	83	82	1	0.651	NN3011K
	60	26	86.1	—	1.1	NN3012	NN3012K	73500	106000	6800	8000	67	—	68	—	88	87	1	0.704	NN3012K
	65	26	91	—	1.1	NN3013	NN3013K	77000	116000	6400	7600	72	—	74	—	93	92	1	0.758	NN3013K
70	110	30	100	—	1.1	NN3014	NN3014K	97500	148000	5700	6800	77	—	78	—	103	101	1	1.04	NN3014K
	75	30	105	—	1.1	NN3015	NN3015K	96500	149000	5500	6400	82	—	84	—	108	106	1	1.14	NN3015K
	80	34	113	—	1.1	NN3016	NN3016K	119000	186000	5000	6000	87	—	90	—	118	114	1	1.52	NN3016K
85	130	34	118	—	1.1	NN3017	NN3017K	125000	201000	4800	5600	92	—	96	—	123	119	1	1.61	NN3017K
	90	37	127	—	1.5	NN3018	NN3018K	143000	228000	4500	5200	98.5	—	100	—	131.5	129	1.5	2.07	NN3018K
	95	37	132	—	1.5	NN3019	NN3019K	150000	246000	4300	5000	103.5	—	106	—	136.5	134	1.5	2.17	NN3019K
100	140	40	—	113	1.1	NNU4920	NNU4920K	155000	305000	4200	5000	106.5	111	110	115	133.5	—	1	1.77	NNU4920K
	150	37	137	—	1.5	NN3020	NN3020K	157000	265000	4000	4800	108.5	—	112	—	141.5	139	1.5	2.26	NN3020K
	105	40	—	118	1.1	NNU4921	NNU4921K	161000	325000	4000	4800	111.5	116	115	120	138.5	—	1	1.85	NNU4921K
110	160	41	146	—	2	NN3021	NN3021K	198000	320000	3800	4500	115	—	116	—	150	148	2	2.89	NN3021K
	150	40	—	123	1.1	NNU4922	NNU4922K	167000	335000	3900	4600	116.5	121	120	125	143.5	—	1	1.93	NNU4922K
	170	45	155	—	2	NN3022	NN3022K	229000	375000	3600	4300	120	—	122	—	160	157	2	3.68	NN3022K
120	165	45	—	134.5	1.1	NNU4924	NNU4924K	183000	360000	3500	4200	126.5	133	130	137	158.5	—	1	2.65	NNU4924K
	180	46	165	—	2	NN3024	NN3024K	239000	405000	3300	3900	130	—	132	—	170	167	2	3.98	NN3024K
	130	50	—	146	1.5	NNU4926	NNU4926K	275000	565000	3200	3800	138	144	142	148	172	—	1.5	3.55	NNU4926K
140	200	52	182	—	2	NN3026	NN3026K	284000	475000	3000	3600	140	—	144	—	190	183	2	5.92	NN3026K
	190	50	—	156	1.5	NNU4928	NNU4928K	283000	585000	3000	3600	148	154	151	158	182	—	1.5	3.80	NNU4928K
	210	53	192	—	2	NN3028	NN3028K	298000	515000	2800	3400	150	—	154	—	200	194	2	6.44	NN3028K
150	210	60	—	168.5	2	NNU4930	NNU4930K	350000	715000	2700	3300	159	166	162	171	201	—	2	5.95	NNU4930K
	225	56	206	—	2.1	NN3030	NN3030K	335000	585000	2600	3100	162	—	164	—	213	208	2	7.81	NN3030K
	160	220	60	—	178.5	2	NNU4932	NNU4932K	365000	760000	2600	3100	169	176	172	182	211	—	2	6.25
170	240	60	219	—	2.1	NN3032	NN3032K	375000	660000	2500	2900	172	—	174	—	228	221	2	8.92	NN3032K
	230	60	—	188.5	2	NNU4934	NNU4934K	375000	805000	2400	2900	179	186	182	192	221	—	2	6.60	NNU4934K
	260	67	236	—	2.1	NN3034	NN3034K	450000	805000	2300	2700	182	—	184	—	248	238	2	12.6	NN3034K
180	250	69	—	202	2	NNU4936	NNU4936K	480000	1020000	2200	2700	189	199	194	205	241	—	2	9.50	NNU4936K
	280	74	255	—	2.1	NN3036	NN3036K	565000	995000	2100	2500	192	—	196	—	268	257	2	16.6	NN3036K

Double-row Cylindrical Roller Bearings

Bore Diameter: 190~320mm

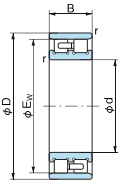

NN
Cylindrical bore

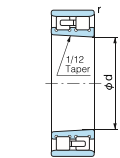

NN
Tapered bore (Taper: 1/12)

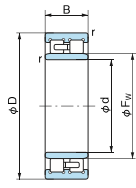

NNU
Cylindrical bore

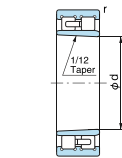

NNU
Tapered bore (Taper: 1/12)

1N=0.102kgf

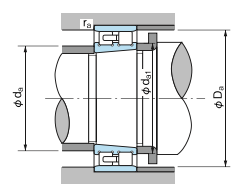
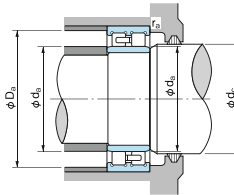

Boundary dimensions (mm)						Bearing No.		Basic dynamic load rating Cr (N)	Basic static load rating Cor (N)	Limiting speed (min ⁻¹)		Abutment and fillet dimensions (mm)								Mass (kg) (Reference Tapered bore)	Bearing No.
d	D	B	Ew	Fw	r (min)	Cylindrical bore	Tapered bore			Grease lubrication	Oil lubrication	da		dc		Da		ra			
										(min)	(max)	(min)	(max)	(min)	(max)	(min)	(max)				
190	260	69	—	212	2	NNU4938	NNU4938K	485000	1060000	2100	2600	199	209	204	215	251	—	2	10.0	NNU4938K	
	290	75	265	—	2.1	NN3038	NN3038K	595000	1080000	2000	2400	202	—	206	—	278	267	2	17.5	NN3038K	
	310	82	282	—	2.1	NN3040	NN3040K	655000	1170000	1900	2200	212	—	216	—	298	285	2	21.6	NN3040K	
220	300	80	—	245	2.1	NNU4944	NNU4944K	600000	1330000	1800	2200	231	242	234	248	289	—	2	15.5	NNU4944K	
	340	90	310	—	3	NN3044	NN3044K	815000	1480000	1700	2000	234	—	238	—	326	313	2.5	28.4	NN3044K	
	360	92	330	—	3	NN3048	NN3048K	855000	1600000	1600	1900	254	—	256	—	346	333	2.5	31.8	NN3048K	
260	360	100	—	292	2.1	NNU4952	NNU4952K	935000	2100000	1500	1800	271	288	276	296	349	—	2	28.3	NNU4952K	
	400	104	364	—	4	NN3052	NN3052K	1080000	2070000	1400	1700	278	—	280	—	382	367	3	46.0	NN3052K	
	380	100	—	312	2.1	NNU4956	NNU4956K	960000	2230000	1400	1700	291	308	296	316	369	—	2	30.3	NNU4956K	
280	420	106	384	—	4	NN3056	NN3056K	1080000	2080000	1300	1600	298	—	300	—	402	387	3	49.6	NN3056K	
	420	118	—	339	3	NNU4960	NNU4960K	1230000	2880000	1300	1500	313	335	320	343	407	—	2.5	46.7	NNU4960K	
	460	118	418	—	4	NN3060	NN3060K	1430000	2740000	1200	1400	318	—	325	—	442	421	3	68.7	NN3060K	
320	440	118	—	359	3	NNU4964	NNU4964K	1270000	3050000	1200	1400	333	335	340	363	427	—	2.5	49.6	NNU4964K	
	480	121	438	—	4	NN3064	NN3064K	1430000	2750000	1200	1400	338	—	345	—	462	442	3	74.0	NN3064K	



Tapered Roller Bearings

Tolerance / Metric series Page 57
 / Inch series Page 60
 Internal clearance / Double-row
 Tapered Roller Bearings Page 64

● Interchangeability

Bearings designated as E J (E prefix and J suffix) comply with ISO standards in sub-unit dimensions. The cups and cones of these bearings are internationally interchangeable.

- α : Contact angle
- C : Cup width
- E : Cup smallest internal diameter

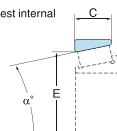

Fig 1. Sub-unit dimensions

● Combination and Double-row Tapered Roller Bearings

When radial loads act on a Tapered roller bearing, an axial load is generated from the reaction of the internal contact angle of the bearing. This induced axial load creates a separating force on the cup and cone which is normally offset by mounting Tapered roller bearings in pairs or as multi-row sets.

Table 1 shows combination and double-row mounting of Tapered roller bearings.

● Inch Series

NACHI manufactures inch-dimensioned series Tapered Roller Bearings to ABMA (ANSI) standards.

Table 1. Double-row Tapered Roller Bearing Configurations and Features

Series or Configuration	Cross section	Example Bearing Number	Adjustment
Back-to-back (DB mounting)		E32208JDB10	Combination of two standard single-row Tapered roller bearings. Two mounting systems are used; one using preset spacers, and the other requiring adjustment using either torque or end-play control.
Face-to-face (DF mounting)		E32208JDF	
KBE KDE		150KBE030	Either double inner or outer ring. Adjustment is normally done using spacers. If spacers are not used, please contact NACHI for end-play specifications.
KBD		150KBD030	

Tapered Roller Bearings
Metric Series

Bore Diameter: 15~35mm

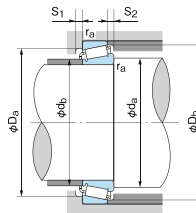
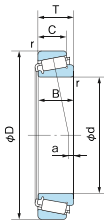

Dynamic equivalent radial load
 $F_r = XFr + YFa$

$\frac{F_a}{F_r} \leq e$		$\frac{F_a}{F_r} > e$	
X	Y	X	Y
1	0	0.4	Y_1

Values e and Y_1 from table.

Static equivalent radial load

Larger value of following to be used:
 $P_0 = 0.5Fr + Y_0Fa$
 $P_0 = Fr$
Values Y_0 from table.

1N=0.102kgf

Boundary dimensions (mm)						Bearing No.	(Ref.) ISO355 Dimension series	Basic dynamic load rating Cr (N)	Basic static load rating Cor (N)	Limiting speed (min ⁻¹)		Abutment and fillet dimensions (mm)						Load center (mm) a (*)	Constant e	Axial load factor		Mass(kg) Reference	Bearing No.			
d	D	T	B	C	Cone r (min)					Cup r (min)	Grease lubrication	Oil lubrication	da (min)	db (max)	Da (min)	Db (min)	S1 (min)			S2 (min)	Cone ra (max)			Cup	Y1	Y0
15	35	11.75	11	10	0.6	0.6	H-E30202	—	15800	14500	12000	16000	19.5	20	29	33	2	1.7	0.6	0.6	3.4	0.32	1.88	1.04	0.054	H-E30202
	42	14.25	13	11	1	1	H-E30302J	2FB	21900	19200	10000	14000	20.5	22	36.5	38	2	3	1	1	4.3	0.29	2.11	1.16	0.098	H-E30302J
17	40	13.25	12	11	1	1	H-E30203J	2DB	20800	20700	10000	14000	22.5	23	33	37	2	2	1	1	3.2	0.35	1.74	0.96	0.081	H-E30203J
	47	15.25	14	12	1	1	H-E30303J	2FB	27400	24500	9200	12000	22.5	25	40	42	2	3	1	1	4.3	0.29	2.11	1.16	0.133	H-E30303J
20	47	20.25	19	16	1	1	H-32303	—	31900	29900	9400	13000	22.5	25	39	43	2	4	1	1	7.9	0.29	1.97	1.08	0.176	H-32303
	42	15	15	12	0.6	0.6	H-E32004J	3CC	27300	31500	9300	13000	24.5	25	35	39	3	3	0.6	0.6	4.5	0.37	1.60	0.88	0.102	H-E32004J
	47	15.25	14	12	1	1	H-E30204J	2DB	27000	27200	8700	12000	25.5	27	39	44	2	3	1	1	3.5	0.35	1.74	0.95	0.127	H-E30204J
	47	19.25	18	15	1	1	H-E32204	—	32500	34800	8700	12000	25.5	27	39	43	2	4	1	1	6.2	0.35	1.73	0.95	0.156	H-E32204
25	52	16.25	16	13	1.5	1.5	H-E30304J	—	36400	35200	8300	11000	28.5	28	44	47	2	3	1.5	1.5	3.0	0.30	2.00	1.10	0.179	H-E30304J
	52	22.25	21	18	1.5	1.5	H-E32304J	2FD	45100	46700	8400	11000	28.5	27	43	47	3	4	1.5	1.5	7.8	0.30	2.00	1.10	0.239	H-E32304J
	47	15	15	11.5	0.6	0.6	H-E32005J	4CC	30200	37700	8300	11000	29.5	30	40	44	3	3.5	0.6	0.6	3.2	0.43	1.39	0.77	0.118	H-E32005J
	47	17	17	14	0.6	0.6	H-E33005J	2CE	33500	42300	8300	11000	29.5	30	41	44	3	3	0.6	0.6	6.1	0.29	2.07	1.14	0.131	H-E33005J
30	52	16.25	15	13	1	1	H-E30205J	3CC	31500	33700	7500	10000	30.5	31	44	48	2	3	1	1	3.3	0.37	1.60	0.88	0.156	H-E30205J
	52	19.25	18	16	1	1	H-E32205J	2CD	39800	44800	7900	11000	30.5	31	43	48	2	4	1	1	5.7	0.36	1.67	0.92	0.188	H-E32205J
	52	22	22	18	1	1	H-E33205J	2DE	48900	58500	7900	10000	30.5	30	43	49	4	4	1	1	7.9	0.35	1.71	0.94	0.225	H-E33205J
	62	18.25	17	15	1.5	1.5	H-E30305J	2FB	48200	46900	6800	9000	33.5	34	54	57	2	3	1.5	1.5	5.4	0.30	2.00	1.10	0.273	H-E30305J
35	62	18.25	17	13	1.5	1.5	H-E30305DJ	7FB	39800	42500	5700	8000	33.5	34	47	58.5	3	5	1.5	1.5	-2.2	0.83	0.73	0.40	0.269	H-E30305DJ
	62	25.25	24	20	1.5	1.5	H-E32305J	2FD	61200	64100	6900	9100	33.5	33	52	57	3	5	1.5	1.5	8.6	0.30	2.00	1.10	0.386	H-E32305J
	55	17	17	13	1	1	H-E32006J	4CC	38200	48000	7000	9400	35.5	35	47	52	3	4	1	1	3.4	0.43	1.39	0.77	0.177	H-E32006J
	55	20	20	16	1	1	H-E33006J	2CE	43200	55200	7000	9400	35.5	36	48	52	3	4	1	1	7.0	0.29	2.06	1.13	0.203	H-E33006J
40	62	17.25	16	14	1	1	H-E30206J	3DB	41500	44800	6500	8700	35.5	37	53	57	2	3	1	1	3.1	0.37	1.60	0.88	0.236	H-E30206J
	62	21.25	20	17	1	1	H-E32206J	3DC	50700	57900	6500	8700	35.5	37	52	58	2	4	1	1	5.3	0.37	1.60	0.88	0.292	H-E32206J
	62	25	25	19.5	1	1	H-E33206J	2DE	66400	79400	6500	8700	35.5	36	53	58	2	5.5	1	1	8.7	0.34	1.76	0.97	0.359	H-E33206J
	72	20.75	19	16	1.5	1.5	H-E30306J	2FB	59600	60100	5800	7700	38.5	40	62	66	3	4.5	1.5	1.5	5.1	0.31	1.90	1.05	0.411	H-E30306J
45	72	20.75	19	14	1.5	1.5	H-E30306DJ	7FB	50900	54900	4900	6800	38.5	40	55	68	3	6.5	1.5	1.5	-2.9	0.83	0.73	0.40	0.400	H-E30306DJ
	72	28.75	27	23	1.5	1.5	H-E32306J	2FD	82200	91600	5900	7900	38.5	39	59	66	3	5.5	1.5	1.5	9.8	0.31	1.90	1.05	0.588	H-E32306J
	55	14	14	11.5	0.6	0.6	E32907J	2BD	26100	36500	6600	8800	39.5	40	49	52	2.5	2.5	0.6	0.6	3.1	0.29	2.06	1.13	0.120	E32907J
	62	18	18	14	1	1	H-E32007J	4CC	45500	59400	6200	8200	40.5	40	54	59	4	4	1	1	2.9	0.45	1.32	0.73	0.231	H-E32007J
50	62	21	21	17	1	1	H-E33007J	2CE	51300	68000	6200	8200	40.5	41	55	59	3	4	1	1	6.8	0.31	1.97	1.08	0.263	H-E33007J
	72	18.25	17	15	1.5	1.5	H-E30207J	3DB	55100	60900	5600	7400	43.5	44	62	67	3	3	1.5	1.5	2.9	0.37	1.60	0.88	0.344	H-E30207J
	72	24.25	23	19	1.5	1.5	H-E32207J	3DC	69600	82400	5600	7500	43.5	43	61	67	3	5	1.5	1.5	6.0	0.37	1.60	0.88	0.453	H-E32207J
	72	28	28	22	1.5	1.5	H-E33207J	2DE	86700	107000	5700	7500	43.5	42	61	68	5	6	1.5	1.5	9.6	0.35	1.70	0.93	0.551	H-E33207J
55	80	22.75	21	18	2	1.5	H-E30307J	2FB	76200	78900	5200	6900	45	45	70	74	3	4.5	2	1.5	5.8	0.31	1.90	1.05	0.527	H-E30307J
	80	22.75	21	15	2	1.5	H-E30307DJ	7FB	63100	69100	4300	6000	45	44	66	76.5	3	7.5	2	1.5	-4.1	0.83	0.73	0.40	0.536	H-E30307DJ
	80	32.75	31	25	2	1.5	H-E32307J	2FE	101000	114000	5300	7000	45	44	66	74	3	7.5	2	1.5	12.2	0.31	1.90	1.05	0.776	H-E32307J

Note: (*) Minus value of load center "a" indicates that the center is located outside of cone backface.

Tapered Roller Bearings
Metric Series

Bore Diameter: 40~50mm

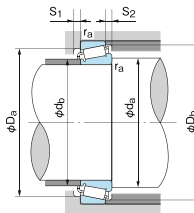
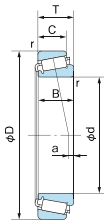

Dynamic equivalent radial load
 $P_r = XFr + YFa$

$\frac{Fa}{Fr} \leq e$		$\frac{Fa}{Fr} > e$	
X	Y	X	Y
1	0	0.4	Y_1

Values e and Y_1 from table.

Static equivalent radial load

Larger value of following to be used:
 $P_0 = 0.5Fr + Y_0Fa$
 $P_0 = Fr$
Values Y_0 from table.

1N=0.102kgf

Boundary dimensions (mm)						Bearing No.	(Ref.) ISO355 Dimension series	Basic dynamic load rating Cr (N)	Basic static load rating Cor (N)	Limiting speed (min ⁻¹)		Abutment and fillet dimensions (mm)						Load center (mm) a (°)	Constant e	Axial load factor		Mass(kg) Reference	Bearing No.			
d	D	T	B	C	Cone r (min)					Cup r (min)	Grease lubrication	Oil lubrication	da (min)	db (max)	Da (min)	Db (min)	S1 (min)			S2 (min)	Cone ra (max)			Cup	Y1	Y0
40	62	15	15	12	0.6	0.6	H-E32908J	2BC	33500	48500	5900	7800	44.5	45	55	59	3	3	0.6	0.6	3.1	0.29	2.07	1.14	0.164	H-E32908J
	68	19	19	14.5	1	1	H-E32008J	3CD	53500	71400	5600	7400	45.5	46	60	65	4	4.5	1	1	3.9	0.38	1.58	0.87	0.282	H-E32008J
	68	22	22	18	1	1	H-E33008J	2BE	60400	84600	5500	7400	45.5	46	60	65	3	4	1	1	7.3	0.28	2.12	1.17	0.326	H-E33008J
	75	26	26	20.5	1.5	1.5	H-E33108J	2CE	82200	108000	5200	6900	48.5	47	65	71	4	5.5	1.5	1.5	7.7	0.36	1.69	0.93	0.508	H-E33108J
	80	19.75	18	16	1.5	1.5	H-E30208J	3DB	62900	69200	5000	6700	48.5	49	69	75	3	3.5	1.5	1.5	2.7	0.37	1.60	0.88	0.434	H-E30208J
	80	24.75	23	19	1.5	1.5	H-E32208J	3DC	77700	90800	5000	6600	48.5	48	68	75	3	5.5	1.5	1.5	5.3	0.37	1.60	0.88	0.554	H-E32208J
	80	32	32	25	1.5	1.5	H-E33208J	2DE	108000	139000	5000	6700	48.5	47	67	76	5	7	1.5	1.5	11.3	0.36	1.68	0.92	0.758	H-E33208J
	90	25.25	23	20	2	1.5	H-E30308J	2FB	90600	101000	4500	6100	50	52	77	82	3	5	2	1.5	5.4	0.35	1.74	0.96	0.757	H-E30308J
	90	25.25	23	17	2	1.5	H-E30308DJ	7FB	80500	90200	3800	5300	50	51	71	86	3	8	2	1.5	-4.6	0.83	0.73	0.40	0.757	H-E30308DJ
	90	35.25	33	27	2	1.5	H-E32308J	2FD	116000	139000	4600	6200	50	50	73	82	3	8	2	1.5	10.9	0.35	1.74	0.96	1.06	H-E32308J
45	68	15	15	12	0.6	0.6	H-E32909J	2BC	34700	52400	5300	7100	49.5	50	61	64	3	3	0.6	0.6	2.5	0.32	1.88	1.04	0.190	H-E32909J
	75	20	20	15.5	1	1	H-E32009J	3CC	62800	86500	5000	6600	50.5	51	67	72	4	4.5	1	1	3.5	0.39	1.53	0.84	0.354	H-E32009J
	75	24	24	19	1	1	H-E33009J	2CE	69600	101000	5000	6700	50.5	51	67	71	4	5	1	1	7.6	0.29	2.04	1.12	0.416	H-E33009J
	80	26	26	20.5	1.5	1.5	E33109J	3CE	87500	120000	4800	6400	53.5	52	69	76.5	4	5.5	1.5	1.5	6.6	0.38	1.57	0.86	0.563	E33109J
	85	20.75	19	16	1.5	1.5	H-E30209J	3DB	67200	77400	4600	6100	53.5	54	74	80	3	4.5	1.5	1.5	1.8	0.40	1.48	0.81	0.502	H-E30209J
	85	24.75	23	19	1.5	1.5	H-E32209J	3DC	78300	94100	4600	6100	53.5	53	73	81	3	5.5	1.5	1.5	3.8	0.40	1.48	0.81	0.587	H-E32209J
	85	32	32	25	1.5	1.5	E33209J	3DE	112000	149000	4600	6200	53.5	52	76.5	81	5	7	1.5	1.5	10.2	0.39	1.56	0.86	0.803	E33209J
	100	27.25	25	22	2	1.5	E30309J	2FB	113000	128000	4100	5400	55	59	86	93	3	5	2	1.5	5.9	0.35	1.74	0.96	1.01	E30309J
	100	27.25	25	18	2	1.5	E30309DJ	7FB	95100	107000	3400	4700	55	56	79	96	3	9	2	1.5	-5.7	0.83	0.73	0.40	0.973	E30309DJ
	100	38.25	36	30	2	1.5	E32309J	2FD	146000	180000	4100	5500	55	56	82	93	3	8	2	1.5	11.4	0.35	1.74	0.96	1.43	E32309J
50	72	15	15	12	0.6	0.6	E32910J	2BC	35900	56300	4900	6600	54.5	55	65	69	3	3	0.6	0.6	1.3	0.34	1.76	0.97	0.195	E32910J
	80	20	20	15.5	1	1	H-E32010J	3CC	65700	94500	4600	6100	55.5	56	72	77	4	4.5	1	1	2.3	0.42	1.42	0.78	0.389	H-E32010J
	80	24	24	19	1	1	E33010J	2CE	73000	110000	4600	6100	55.5	56	72	76	4	5	1	1	6.6	0.32	1.90	1.04	0.451	E33010J
	85	26	26	20	1.5	1.5	E33110J	3CE	89400	127000	4400	5900	58.5	56	74	81.5	4	6	1.5	1.5	5.4	0.41	1.46	0.80	0.594	E33110J
	90	21.75	20	17	1.5	1.5	H-E30210J	3DB	76500	91700	4300	5700	58.5	58	79	85	3	4.5	1.5	1.5	1.65	0.42	1.43	0.79	0.566	H-E30210J
	90	24.75	23	19	1.5	1.5	H-E32210J	3DC	85000	105000	4300	5700	58.5	58	78	85	3	5.5	1.5	1.5	4.1	0.42	1.43	0.79	0.643	H-E32210J
	90	32	32	24.5	1.5	1.5	H-E33210J	3DE	119000	167000	4300	5700	58.5	57	77	86.5	5	7.5	1.5	1.5	8.9	0.41	1.45	0.80	0.887	H-E33210J
	110	29.25	27	23	2.5	2	E30310J	2FB	137000	152000	3700	4900	62	65	95	102	3	6	2	2	6.4	0.35	1.74	0.96	1.32	E30310J
	110	29.25	27	19	2.5	2	E30310DJ	7FB	115000	133000	3100	4300	62	62	87	105	3	10	2	2	-5.8	0.83	0.73	0.40	1.25	E30310DJ
	110	42.25	40	33	2.5	2	E32310J	2FD	176000	220000	3700	5000	62	62	90	102	3	9	2	2	12.9	0.35	1.74	0.96	1.89	E32310J

Note: (°) Minus value of load center "a" indicates that the center is located outside of cone backface.

Tapered Roller Bearings
Metric Series

Bore Diameter: 55~65mm

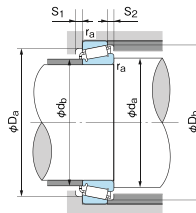
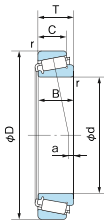

Dynamic equivalent radial load
 $F_r = XFr + YFa$

$\frac{F_a}{F_r} \leq e$		$\frac{F_a}{F_r} > e$	
X	Y	X	Y
1	0	0.4	Y_1

Values e and Y_1 from table.

Static equivalent radial load

Larger value of following to be used:
 $P_0 = 0.5Fr + Y_0Fa$
 $P_0 = Fr$
Values Y_0 from table.

1N=0.102kgf

Boundary dimensions (mm)							Bearing No.	(Ref.) ISO355 Dimension series	Basic dynamic load rating Cr (N)	Basic static load rating Cor (N)	Limiting speed (min ⁻¹)		Abutment and fillet dimensions (mm)							Load center (mm) a (°)	Constant e	Axial load factor		Mass(kg) Reference	Bearing No.	
d	D	T	B	C	Cone r (min)	Cup r (min)					Grease lubrication	Oil lubrication	da (min)	db (max)	Da (min)	Db (min)	S1 (min)	S2 (min)	Cone ra (max)			Cup	Y1			Y0
55	80	17	17	14	1	1	E32911J	2BC	44600	73300	4400	5900	61	61	72	76	3	3	1	1	2.5	0.31	1.94	1.07	0.285	E32911J
	90	23	23	17.5	1.5	1.5	H-E32011J	3CC	84600	121000	4100	5500	63.5	63	81	86	4	5.5	1.5	1.5	3.2	0.41	1.48	0.81	0.569	H-E32011J
	90	27	27	21	1.5	1.5	E33011J	2CE	96500	149000	4100	5400	63.5	63	81	86	5	6	1.5	1.5	7.3	0.31	1.92	1.06	0.672	E33011J
	95	30	30	23	1.5	1.5	E33111J	3CE	116000	161000	4000	5300	63.5	62	83	91	5	7	1.5	1.5	7.5	0.37	1.60	0.88	0.868	E33111J
	100	22.75	21	18	2	1.5	E30211J	3DB	94600	113000	3900	5200	65	64	88	94	4	4.5	2	1.5	2.0	0.40	1.48	0.81	0.732	E30211J
	100	26.75	25	21	2	1.5	E32211J	3DC	107000	133000	3900	5200	65	63	87	95	4	5.5	2	1.5	3.7	0.40	1.48	0.81	0.863	E32211J
	100	35	35	27	2	1.5	E32311J	3DE	142000	189000	3900	5200	65	62	85	96	6	8	2	1.5	9.7	0.40	1.50	0.83	1.18	E32311J
60	120	31.5	29	25	2.5	2	E30311J	2FB	149000	170000	3300	4500	67	71	104	111	4	6.5	2	2	6.0	0.35	1.74	0.96	1.65	E30311J
	120	31.5	29	21	2.5	2	E30311DJ	7FB	129000	148000	2900	4000	67	68	94	113	4	10.5	2	2	-6.9	0.83	0.73	0.40	1.59	E30311DJ
	120	45.5	43	35	2.5	2	E32311J	2FD	200000	250000	3400	4500	67	68	99	111	4	10.5	2	2	13.1	0.35	1.74	0.96	2.38	E32311J
	85	17	17	14	1	1	E32912J	2BC	46200	78200	4100	5500	65.5	66	77	81	3	3	1	1	1.4	0.33	1.81	1.00	0.306	E32912J
	95	23	23	17.5	1.5	1.5	E32012J	4CC	86100	127000	3900	5200	68.5	67	85	91	4	5.5	1.5	1.5	2.0	0.43	1.39	0.77	0.621	E32012J
	95	27	27	21	1.5	1.5	E33012J	2CE	101000	162000	3900	5200	68.5	67	85	90	5	6	1.5	1.5	6.9	0.33	1.83	1.01	0.719	E33012J
	100	30	30	23	1.5	1.5	E33112J	3CE	118000	170000	3600	4900	68.5	67	88	96	5	7	1.5	1.5	6.3	0.40	1.51	0.83	0.923	E33112J
65	110	23.75	22	19	2	1.5	E30212J	3EB	106000	127000	3500	4700	70	70	96	103	4	4.5	2	1.5	1.8	0.40	1.48	0.81	0.945	E30212J
	110	29.75	28	24	2	1.5	E32212J	3EC	132000	167000	3500	4700	70	69	95	104	4	5.5	2	1.5	4.6	0.40	1.48	0.81	1.19	E32212J
	110	38	38	29	2	1.5	E32312J	3EE	174000	239000	3600	4700	70	69	93	105	6	9	2	1.5	10.8	0.40	1.48	0.82	1.57	E32312J
	130	33.5	31	26	3	2.5	E30312J	2FB	173000	201000	3100	4100	74	77	112	120	4	7.5	2.5	2	6.6	0.35	1.74	0.96	2.08	E30312J
	130	33.5	31	22	3	2.5	E30312DJ	7FB	153000	179000	2600	3700	74	73	103	124	4	11.5	2.5	2	-7.3	0.83	0.73	0.40	2.01	E30312DJ
	130	48.5	46	37	3	2.5	E32312J	2FD	221000	275000	3100	4200	74	74	107	120	4	11.5	2.5	2	16.2	0.35	1.74	0.96	2.92	E32312J
	90	17	17	14	1	1	E32913J	2BC	47400	83100	3900	5200	70.5	70	81	86	3	3	1	1	0.2	0.35	1.70	0.93	0.327	E32913J
65	100	23	23	17.5	1.5	1.5	E32013J	4CC	90000	137000	3600	4800	73.5	72	90	97	4	5.5	1.5	1.5	0.5	0.46	1.31	0.72	0.664	E32013J
	100	27	27	21	1.5	1.5	E33013J	2CE	103000	169000	3600	4800	73.5	72	89	96	5	6	1.5	1.5	5.9	0.35	1.72	0.95	0.762	E33013J
	110	34	34	26.5	1.5	1.5	E33113J	3DE	152000	223000	3400	4600	73.5	73	96	106	6	7.5	1.5	1.5	8.1	0.39	1.55	0.85	1.33	E33113J
	120	24.75	23	20	2	1.5	E30213J	3EB	128000	156000	3200	4300	75	77	106	113	4	4.5	2	1.5	0.6	0.40	1.48	0.81	1.18	E30213J
	120	32.75	31	27	2	1.5	E32213J	3EC	157000	203000	3200	4300	75	76	104	115	4	5.5	2	1.5	6.1	0.40	1.48	0.82	1.58	E32213J
	120	41	41	32	2	1.5	E32313J	3EE	200000	277000	3200	4300	75	74	102	115	7	9	2	1.5	11	0.39	1.54	0.85	2.02	E32313J
	140	36	33	28	3	2.5	E30313J	2GB	204000	239000	2800	3800	79	83	122	130	4	8	2.5	2	6.7	0.35	1.74	0.96	2.56	E30313J
	140	36	33	23	3	2.5	E30313DJ	7GB	176000	209000	2400	3400	79	79	111	133	4	13	2.5	2	-8.3	0.83	0.73	0.40	2.44	E30313DJ
	140	51	48	39	3	2.5	E32313J	2GD	276000	357000	2900	3900	79	80	117	130	4	12	2.5	2	16.3	0.35	1.74	0.96	3.64	E32313J

Note: (°) Minus value of load center "a" indicates that the center is located outside of cone backface.

Tapered Roller Bearings
Metric Series

Bore Diameter: 70~80mm

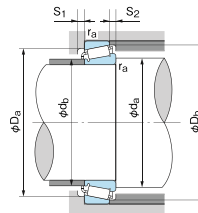
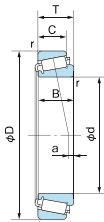

■ Dynamic equivalent radial load

$$Fr = XFr + YFa$$

$\frac{Fa}{Fr} \leq e$		$\frac{Fa}{Fr} > e$	
X	Y	X	Y
1	0	0.4	Y_1

Values e and Y_1 from table.

■ Static equivalent radial load

Larger value of following to be used:

$$Por = 0.5Fr + Y_0Fa$$

$$Por = Fr$$

Values Y_0 from table.

1N=0.102kgf

Boundary dimensions (mm)							Bearing No.	(Ref.) ISO355 Dimension series	Basic dynamic load rating Cr (N)	Basic static load rating Cor (N)	Limiting speed (min ⁻¹)		Abutment and fillet dimensions (mm)							Load center (mm) a (°)	Constant e	Axial load factor		Mass(kg) Reference	Bearing No.	
d	D	T	B	C	Cone r (min)	Cup r (min)					Grease lubrication	Oil lubrication	da (min)	db (max)	Da (min)	Ds (min)	S1 (min)	S2 (min)	Cone ra (max)			Cup	Y1			Y0
70	100	20	20	16	1	1	E32914J	2BC	71000	115000	3500	4700	75.5	77	91	96	4	4	1	1	2.2	0.32	1.90	1.05	0.496	E32914J
	110	25	25	19	1.5	1.5	E32014J	4CC	108000	163000	3300	4400	78.5	78	98	105	5	6	1.5	1.5	1.4	0.43	1.38	0.76	0.884	E32014J
	110	31	31	25.5	1.5	1.5	E33014J	2CE	134000	208000	3300	4400	78.5	78	99	105	5	5.5	1.5	1.5	8.1	0.28	2.11	1.16	1.09	E33014J
	125	26.25	24	21	2	1.5	E30214J	3EB	138000	173000	3100	4100	80	81	110	118	4	5	2	1.5	0.3	0.42	1.43	0.79	1.32	E30214J
	125	33.25	31	27	2	1.5	E32214J	3EC	169000	225000	3100	4100	80	80	108	119	4	6	2	1.5	4.0	0.42	1.43	0.79	1.71	E32214J
	125	41	41	32	2	1.5	E33214J	3EE	206000	294000	3100	4100	80	79	107	120	7	9	2	1.5	9.8	0.41	1.47	0.81	2.16	E33214J
	150	38	35	30	3	2.5	E30314J	2GB	230000	273000	2600	3500	84	89	130	140	4	8	2.5	2	7.5	0.35	1.74	0.96	3.08	E30314J
150	38	35	25	3	2.5	E30314DJ	7GB	197000	235000	2300	3200	84	84	118	142	4	13	2.5	2	-9.1	0.63	0.73	0.40	2.97	E30314DJ	
150	54	51	42	3	2.5	E32314J	2GD	317000	414000	2700	3600	84	86	125	140	4	12	2.5	2	16.6	0.35	1.74	0.96	4.50	E32314J	
75	105	20	20	16	1	1	E32915J	2BC	73600	123000	3300	4400	80.5	81	97	101	4	4	1	1	1.1	0.33	1.80	0.99	0.526	E32915J
	115	25	25	19	1.5	1.5	E32015J	4CC	110000	169000	3100	4200	83.5	83	103	110	5	6	1.5	1.5	-0.1	0.46	1.31	0.72	0.93	E32015J
	115	31	31	25.5	1.5	1.5	E33015J	2CE	141000	225000	3000	4100	83.5	83	104	110	6	5.5	1.5	1.5	8.1	0.30	2.01	1.11	1.16	E33015J
	125	27	27	22	2	1.5	E33115J	3DE	186000	280000	3000	4000	85	84	109	120	6	8	2	1.5	7.5	0.40	1.51	0.83	1.84	E33115J
	130	27.25	25	22	2	1.5	E30215J	4DB	142000	181000	2900	3900	85	86	115	124	4	5	2	1.5	-0.3	0.44	1.38	0.76	1.42	E30215J
	130	33.25	31	27	2	1.5	E32215J	4DC	174000	234000	2900	3900	85	85	114	123	4	6	2	1.5	3.0	0.44	1.38	0.76	1.77	E32215J
	130	41	41	31	2	1.5	E33215J	3EE	212000	310000	2900	3900	85	83	111	125	7	10	2	1.5	8.5	0.43	1.40	0.77	2.26	E33215J
80	160	40	37	31	3	2.5	E30315	2GB	250000	297000	2500	3300	89	95	139	149	4	9	2.5	2	8.1	0.35	1.73	0.95	3.52	E30315
	160	40	37	26	3	2.5	E30315D	-	222000	266000	2100	2900	89	91	127	151	6	14	2.5	2	-8.8	0.81	0.74	0.41	3.47	E30315D
	160	58	55	45	3	2.5	E32315J	2GD	363000	481000	2500	3300	89	91	133	149	4	13	2.5	2	18	0.35	1.74	0.96	5.41	E32315J
	110	20	20	16	1	1	E32916J	2BC	76100	131000	3100	4200	85.5	86	101	106	4	4	1	1	-0.1	0.35	1.71	0.94	0.556	E32916J
	125	29	29	22	1.5	1.5	E32016J	3CC	147000	225000	2900	3900	88.5	89	112	120	6	7	1.5	1.5	2.3	0.42	1.42	0.78	1.32	E32016J
	125	36	36	29.5	1.5	1.5	E33016J	2CE	173000	288000	2900	3900	88.5	90	112	119	6	6.5	1.5	1.5	10.9	0.28	2.16	1.19	1.63	E33016J
	130	37	37	29	2	1.5	E33116J	3DE	191000	294000	2800	3800	90	89	114	126	6	8	2	1.5	6.5	0.42	1.44	0.79	1.93	E33116J
80	140	28.25	26	22	2.5	2	E30216J	3EB	161000	202000	2700	3600	92	91	124	132	4	6	2	2	-0.3	0.42	1.43	0.79	1.72	E30216J
	140	35.25	33	28	2.5	2	E32216J	3EC	203000	271000	2700	3600	92	90	122	134	4	7	2	2	3.8	0.42	1.43	0.79	2.17	E32216J
	140	46	46	35	2.5	2	E33216	3EE	250000	371000	2700	3600	92	89	119	135	7	11	2	2	10.3	0.43	1.41	0.78	2.99	E33216
	170	42.5	39	33	3	2.5	E30316J	2GB	294000	355000	2300	3100	94	102	148	159	4	9.5	2.5	2	7.7	0.35	1.73	0.96	4.46	E30316J
	170	42.5	39	27	3	2.5	E30316DJ	7GB	236000	282000	2000	2800	94	97	134	159	6	15.5	2.5	2	-11.0	0.83	0.73	0.40	4.12	E30316DJ
	170	61.5	58	48	3	2.5	E32316	2GD	378000	497000	2300	3100	94	98	142	159	4	13.5	2.5	2	19.5	0.35	1.73	0.95	6.32	E32316

Note: (°) Minus value of load center "a" indicates that the center is located outside of cone backface.

Tapered Roller Bearings
Metric Series

Bore Diameter: 85~95mm

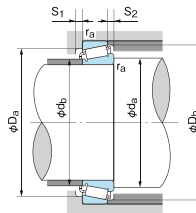
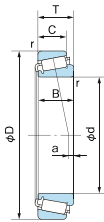

Dynamic equivalent radial load
 $F_r = XFr + YFa$

$\frac{F_a}{Fr} \leq e$		$\frac{F_a}{Fr} > e$	
X	Y	X	Y
1	0	0.4	Y_1

Values e and Y_1 from table.

Static equivalent radial load

Larger value of following to be used:
 $P_0 = 0.5Fr + Y_0Fa$
 $P_0 = Fr$
Values Y_0 from table.

1N=0.102kgf

d	Boundary dimensions (mm)					Bearing No.	(Ref.) ISO355 Dimension series	Basic dynamic load rating Cr (N)	Basic static load rating Cor (N)	Limiting speed (min ⁻¹)		Abutment and fillet dimensions (mm)						Load center (mm) a (°)	Constant e	Axial load factor		Mass(kg) Reference	Bearing No.			
	D	T	B	C	Cone r (min)					Cup r (min)	Grease lubrication	Oil lubrication	da (min)	db (max)	Da (min)	Db (min)	S1 (min)			S2 (min)	Cone ra (max)			Cup	Y1	Y0
85	120	23	23	18	1.5	1.5	E32917J	2BC	97100	165000	2900	3900	93.5	93	109	115	5	5	1.5	1.5	1.8	0.33	1.83	1.01	0.794	E32917J
	130	29	29	22	1.5	1.5	E32017J	4CC	150000	234000	2800	3700	93.5	94	117	125	6	7	1.5	1.5	1.0	0.44	1.36	0.75	1.38	E32017J
	130	36	36	29.5	1.5	1.5	E33017J	2CE	177000	300000	2800	3700	93.5	94	118	125	6	6.5	1.5	1.5	9.7	0.29	2.06	1.13	1.72	E33017J
	140	41	41	32	2.5	2.5	E33117J	3DE	224000	346000	2600	3500	97	95	122	135	7	9	2	2	7.8	0.41	1.48	0.81	2.43	E33117J
	150	30.5	28	24	2.5	2	E30217J	3EB	182000	231000	2500	3400	97	97	132	141	5	6.5	2	2	0.1	0.42	1.43	0.79	2.17	E30217J
	150	38.5	36	30	2.5	2	E32217J	3EC	232000	315000	2500	3300	97	96	130	142	5	8.5	2	2	4.3	0.42	1.43	0.79	2.80	E32217J
	150	49	49	37	2.5	2	E33217J	3EE	294000	439000	2500	3400	97	95	128	144	7	12	2	2	11.9	0.42	1.43	0.79	3.63	E33217J
180	44.5	41	34	4	3	E30317	—	305000	367000	2200	2900	103	107	156	167	5	10.5	3	2.5	8.7	0.35	1.73	0.95	4.97	E30317	
180	44.5	41	28	4	3	E30317DJ	—	263000	317000	1900	2600	103	103	143	169	6	16.5	3	2.5	-11.8	0.83	0.73	0.41	4.81	E30317DJ	
180	63.5	60	49	4	3	E32317J	2GD	439000	587000	2200	3000	103	103	150	167	5	14.5	3	2.5	19.7	0.35	1.74	0.96	7.42	E32317J	
90	125	23	23	18	1.5	1.5	E32918J	2BC	101000	175000	2800	3700	98.5	97	114	120	5	5	1.5	1.5	0.7	0.34	1.75	0.96	0.834	E32918J
	140	32	32	24	2	1.5	E32018J	3CC	178000	276000	2600	3500	100	100	125	134	6	8	2	1.5	2.2	0.42	1.42	0.78	1.80	E32018J
	140	39	39	32.5	2	2	E33018J	2CE	221000	367000	2600	3400	100	100	127	135	7	6.5	2	1.5	11.9	0.27	2.23	1.23	2.22	E33018J
	160	32.5	30	26	2.5	2	E30218J	3FB	204000	261000	2400	3200	102	103	140	150	5	6.5	2	2	-0.1	0.42	1.43	0.79	2.65	E30218J
	160	42.5	40	34	2.5	2	E32218J	3FC	263000	362000	2400	3200	102	102	138	152	5	8.5	2	2	5.5	0.42	1.43	0.79	3.47	E32218J
	190	46.5	43	36	4	3	E30318	—	336000	407000	2100	2700	108	113	165	177	5	10.5	3	2.5	9.3	0.35	1.73	0.95	5.78	E30318
	190	46.5	43	30	4	3	E30318D	—	282000	336000	1700	2400	108	109	151	179	6	16.5	3	2.5	-12.6	0.81	0.74	0.41	5.60	E30318D
190	67.5	64	53	4	3	E32318J	—	461000	614000	2100	2800	108	108	157	177	5	14.5	3	2.5	20.9	0.35	1.74	0.96	8.61	E32318J	
95	130	23	23	18	1.5	1.5	E32919J	2BC	104000	186000	2600	3500	103.5	102	119	125	5	5	1.5	1.5	-0.5	0.36	1.68	0.92	0.876	E32919J
	145	32	32	24	2	1.5	E32019J	4CC	182000	287000	2500	3300	105	105	130	140	6	8	2	1.5	0.8	0.44	1.36	0.75	1.88	E32019J
	145	39	39	32.5	2	1.5	E33019J	2CE	226000	382000	2500	3300	105	104	131	139	7	6.5	2	1.5	11.2	0.28	2.16	1.19	2.31	E33019J
	170	34.5	32	27	3	2.5	E30219J	3FB	231000	299000	2200	3000	109	110	149	159	5	7.5	2.5	2	-0.4	0.42	1.43	0.79	3.20	E30219J
	170	45.5	43	37	3	2.5	E32219J	3FC	311000	439000	2200	3000	109	108	145	161	5	8.5	2.5	2	6.6	0.42	1.43	0.79	4.34	E32219J
	170	58	58	44	3	2.5	E33219J	3FE	374000	582000	2200	2900	109	107	144	163	9	14	2.5	2	15.2	0.41	1.47	0.81	5.66	E33219J
	200	49.5	45	38	4	3	30319	—	317000	368000	2000	2600	113	118	172	186	5	11.5	3	2.5	9.7	0.35	1.73	0.95	6.32	30319
200	49.5	45	32	4	3	E30319DJ	—	319000	391000	1700	2300	113	113	157	187	6	17.5	3	2.5	-13.2	0.81	0.73	0.40	6.68	E30319DJ	
200	71.5	67	55	4	3	E32319J	—	517000	695000	2000	2600	113	115	166	186	5	16.5	3	2.5	21.7	0.35	1.74	0.96	10.1	E32319J	

Note: (°) Minus value of load center "a" indicates that the center is located outside of cone backface.

Tapered Roller Bearings
Metric Series

Bore Diameter: 100~110mm

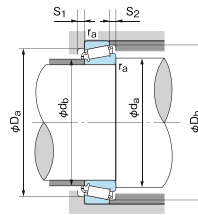
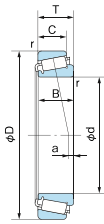

Dynamic equivalent radial load
 $F_r = XFr + YFa$

$\frac{F_a}{F_r} \leq e$		$\frac{F_a}{F_r} > e$	
X	Y	X	Y
1	0	0.4	Y_1

Values e and Y_1 from table.

Static equivalent radial load

Larger value of following to be used:
 $P_0 = 0.5Fr + Y_0Fa$
 $P_0 = Fr$
Values Y_0 from table.

1N=0.102kgf

Boundary dimensions (mm)						Bearing No.	(Ref.) ISO355 Dimension series	Basic dynamic load rating Cr (N)	Basic static load rating Cor (N)	Limiting speed (min ⁻¹)		Abutment and fillet dimensions (mm)						Load center (mm) a (°)	Constant e	Axial load factor		Mass(kg) Reference	Bearing No.			
d	D	T	B	C	Cone r (min)					Cup r (min)	Grease lubrication	Oil lubrication	da (min)	db (max)	Da (min)	Db (min)	S1 (min)			S2 (min)	Cone ra (max)			Cup	Y1	Y0
100	140	25	25	20	1.5	1.5	E32920J	2CC	126000	217000	2400	3300	108.5	108	128	135	5	5	1.5	1.5	1.0	0.33	1.82	1.00	1.19	E32920J
	150	32	32	24	2	1.5	E32020J	4CC	185000	298000	2400	3200	110	109	134	144	6	8	2	1.5	-0.6	0.46	1.31	0.72	1.95	E32020J
	150	39	39	32.5	2	1.5	E33020J	2CE	231000	397000	2400	3200	110	108	135	143	7	6.5	2	1.5	10.4	0.29	2.09	1.15	2.40	E33020J
	165	52	52	40	2.5	2.5	E33120J	3EE	325000	523000	2200	3000	112	111	142	159	8	12	2	2	11.9	0.41	1.48	0.81	4.29	E33120J
	180	37	34	29	3	2.5	E30220J	3FB	258000	338000	2100	2800	114	116	157	168	5	8	2.5	2	0.2	0.42	1.43	0.79	3.83	E30220J
	180	49	46	39	3	2.5	E32220J	3FC	347000	495000	2100	2800	114	114	154	171	5	10	2.5	2	6.9	0.42	1.43	0.79	5.21	E32220J
	180	63	63	48	3	2.5	E33220	3FE	431000	680000	2100	2800	114	112	151	172	10	15	2.5	2	17.3	0.40	1.48	0.82	6.92	E33220
	215	51.5	47	39	4	3	30320	—	344000	400000	1800	2400	118	127	184	200	6	12.5	3	2.5	10.1	0.35	1.73	0.95	7.76	30320
	215	51.5	47	34	4	3	30320D	—	318000	374000	1500	2100	118	121	183	204	5	17	3	2.5	-14.4	0.81	0.74	0.41	8.02	30320D
	215	77.5	73	60	4	3	32320	—	491000	637000	1800	2400	118	123	177	200	8	17.5	3	2.5	24.9	0.35	1.73	0.95	12.2	32320
215	56.5	51	35	4	3	E31320J	—	373000	459000	1500	2200	118	120	183	202	6	17.5	3	2.5	-11.2	0.83	0.73	0.40	8.72	E31320J	
105	145	25	25	20	1.5	1.5	E32921J	2CC	128000	224000	2400	3100	113.5	113	133	140	5	5	1.5	1.5	-0.1	0.34	1.75	0.96	1.23	E32921J
	160	35	35	26	2.5	2	E32021J	4DC	215000	344000	2200	3000	117	116	143	154	6	9	2	2	0.5	0.44	1.35	0.74	2.45	E32021J
	160	43	43	34	2.5	2	E33021J	2DE	267000	461000	2200	3000	117	116	145	153	7	9	2	2	12.1	0.28	2.12	1.17	3.08	E33021J
	190	39	36	30	3	2.5	E30221J	—	288000	380000	2000	2600	119	122	165	178	6	9	2.5	2	0.0	0.42	1.43	0.79	4.49	E30221J
	190	53	50	43	3	2.5	E32221J	3FC	392000	567000	2000	2700	119	120	161	180	6	10	2.5	2	8.2	0.42	1.43	0.79	6.37	E32221J
	225	53.5	49	41	4	3	30321	—	371000	432000	1700	2300	123	132	193	209	7	12.5	3	2.5	10.4	0.35	1.73	0.95	8.74	30321
	225	53.5	49	36	4	3	30321D	—	339000	396000	1400	2000	123	127	193	209	6	11	3	2.5	-15.6	0.81	0.74	0.41	8.76	30321D
225	81.5	77	63	4	3	E32321J	2GD	635000	886000	1800	2300	123	128	185	209	8	18.5	3	2.5	25.4	0.35	1.74	0.96	14.9	E32321J	
110	150	25	25	20	1.5	1.5	E32922J	2CC	129000	231000	2300	3000	118.5	118	138	145	5	5	1.5	1.5	-1.3	0.36	1.69	0.93	1.28	E32922J
	170	38	38	29	2.5	2	E32022J	4DC	248000	395000	2100	2800	122	122	152	163	7	9	2	2	1.9	0.43	1.39	0.77	3.12	E32022J
	170	47	47	37	2.5	2	E33022J	2DE	287000	502000	2100	2800	122	123	152	161	7	10	2	2	13.6	0.29	2.09	1.15	3.81	E33022J
	180	56	56	43	2.5	2	E33122J	3EE	369000	634000	2000	2700	122	121	155	174	9	13	2	2	11.5	0.42	1.43	0.79	5.33	E33122J
	200	41	38	32	3	2.5	E30222J	3FB	324000	434000	1900	2500	124	129	174	188	6	9	2.5	2	0.2	0.42	1.43	0.79	5.33	E30222J
	200	56	53	46	3	2.5	E32222J	3FC	438000	640000	1900	2500	124	126	170	190	6	10	2.5	2	9.3	0.42	1.43	0.79	7.45	E32222J
	240	54.5	50	42	4	3	E30322J	—	481000	590000	1600	2100	128	141	206	222	8	12.5	3	2.5	8.2	0.35	1.74	0.96	11.4	E30322J
	240	54.5	50	36	4	3	30322D	—	365000	429000	1400	1900	128	135	205	222	6	18	3	2.5	-17.0	0.81	0.74	0.41	10.2	30322D
	240	84.5	80	65	4	3	32322	—	607000	796000	1600	2200	128	137	198	222	9	19.5	3	2.5	27.2	0.35	1.73	0.95	16.6	32322

Note: (°) Minus value of load center "a" indicates that the center is located outside of cone backface.

Tapered Roller Bearings
Metric Series

Bore Diameter: 120~140mm

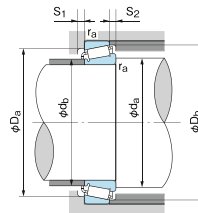
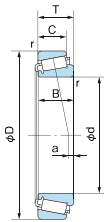

Dynamic equivalent radial load
 $F_r = XFr + YFa$

$\frac{F_a}{F_r} \leq e$		$\frac{F_a}{F_r} > e$	
X	Y	X	Y
1	0	0.4	Y_1

Values e and Y_1 from table.

Static equivalent radial load
Larger value of following to be used:
 $P_0 = 0.5Fr + Y_0Fa$
 $P_0 = Fr$
Values Y_0 from table.

1N=0.102kgf

Boundary dimensions (mm)										Limiting speed (min ⁻¹)		Abutment and fillet dimensions (mm)								Load center (mm) a (°)	Constant e	Axial load factor		Mass(kg) Reference	Bearing No.	
d	D	T	B	C	Cone r (min)	Cup r (min)	Bearing No.	(Ref.) ISO355 Dimension series	Basic dynamic load rating Cr (N)	Basic static load rating Cor (N)	Grease lubrication	Oil lubrication	da (min)	db (max)	Da (min)	Db (min)	S1 (min)	S2 (min)	Cone ra (max)			Cup	Y1			Y0
120	165	29	29	23	1.5	1.5	E32924J	2CC	172000	298000	2100	2700	128.5	128	152	160	6	6	1.5	1.5	-0.4	0.35	1.72	0.95	1.77	E32924J
	180	38	38	29	2.5	2	E32024J	4DC	258000	427000	2000	2600	132	131	161	173	7	9	2	2	-0.8	0.46	1.31	0.72	3.34	E32024J
	180	48	48	38	2.5	2	E33024J	2DE	299000	540000	2000	2600	132	132	160	171	6	10	2	2	11.8	0.31	1.97	1.08	4.16	E33024J
	200	62	62	48	2.5	2	E33124J	3FE	462000	785000	1800	2400	132	133	172	192	9	14	2	2	14.2	0.40	1.51	0.83	7.73	E33124J
	215	43.5	40	34	3	2.5	E30224J	4FE	347000	473000	1700	2300	134	140	187	203	6	9.5	2.5	2	-0.7	0.44	1.38	0.76	6.36	E30224J
	215	61.5	58	50	3	2.5	E32224J	4FD	470000	691000	1700	2300	134	136	181	204	7	11.5	2.5	2	9.9	0.44	1.38	0.76	9.04	E32224J
	260	59.5	55	46	4	3	30324	—	505000	611000	1500	2000	138	152	221	239	10	13.5	3	2.5	10.6	0.35	1.73	0.96	13.7	30324
130	260	59.5	55	37	4	3	30324D	—	430000	512000	1200	1700	138	145	219	239	6	21	3	2.5	-18.3	0.61	0.74	0.41	13.0	30324D
	260	90.5	86	69	4	3	E32324J	2GD	800000	1110000	1500	2000	138	148	213	239	9	21.5	3	2.5	27.8	0.35	1.74	0.96	22.2	E32324J
	260	68	62	42	4	3	E31324J	7GB	526000	665000	1300	1800	138	145	221	244	6	21	3	2.5	-13.9	0.83	0.73	0.40	15.4	E31324J
	180	32	32	25	2	1.5	E32926J	2CC	200000	368000	1900	2500	140	141	165	174	6	7	2	1.5	0.6	0.34	1.77	0.97	2.42	E32926J
	200	45	45	34	2.5	2	E32026J	4EC	340000	563000	1800	2300	142	144	178	192	8	11	2	2	2.1	0.43	1.38	0.76	5.04	E32026J
	200	55	55	43	2.5	2	E33026J	2EE	390000	705000	1700	2300	142	143	178	192	8	12	2	2	12.5	0.34	1.76	0.97	6.19	E33026J
	230	43.75	40	34	4	3	E30226J	4FB	377000	511000	1600	2100	148	152	203	218	7	9.5	3	2.5	-2.7	0.44	1.38	0.76	7.24	E30226J
140	230	67.75	64	54	4	3	E32226J	4FD	554000	830000	1600	2200	148	146	193	219	7	13.5	3	2.5	11.7	0.44	1.38	0.76	11.5	E32226J
	280	63.75	58	41	5	4	E30326D	—	536000	665000	1200	1600	152	155	240	261	7	22	4	3	-20.2	0.81	0.74	0.41	16.4	E30326D
	280	63.75	58	49	5	4	30326	—	563000	684000	1400	1800	152	164	239	255	8	14.5	4	3	10.9	0.35	1.73	0.95	16.9	30326
	280	98.75	93	78	5	4	32326	—	852000	1160000	1400	1800	152	163	226	259	10	15	4	3	29.6	0.35	1.73	0.95	26.5	32326
	280	72	66	44	5	4	E31326J	7GB	589000	748000	1200	1600	152	155	236	261	7	23	4	3	-15.3	0.83	0.73	0.40	18.9	E31326J
	190	32	32	25	2	1.5	E32928J	2CC	206000	390000	1800	2300	150	150	174	184	6	7	2	1.5	-1.6	0.36	1.67	0.92	2.57	E32928J
	210	45	45	34	2.5	2	E32028J	4DC	346000	585000	1700	2200	152	153	187	202	8	11	2	2	-0.6	0.46	1.31	0.72	5.28	E32028J
140	210	56	56	44	2.5	2	E33028J	2DE	406000	758000	1600	2200	152	152	186	202	7	12	2	2	10.4	0.36	1.67	0.92	6.61	E33028J
	250	45.75	42	36	4	3	E30228	—	405000	538000	1500	1900	158	163	219	237	9	9.5	3	2.5	-3.4	0.43	1.39	0.77	8.9	E30228
	250	71.75	68	58	4	3	E32228J	4FD	636000	961000	1500	2000	158	158	210	238	9	13.5	3	2.5	11.7	0.44	1.39	0.76	14.7	E32228J
	300	67.75	62	44	5	4	30328D	—	525000	627000	1100	1500	162	169	254	280	7	23	4	3	-22.4	0.81	0.74	0.41	20.0	30328D
	300	67.75	62	53	5	4	30328	—	626000	761000	1300	1700	162	179	254	273	10	14.5	4	3	12.2	0.35	1.73	0.95	20.4	30328
	300	107.75	102	85	5	4	32328	—	958000	1320000	1300	1700	162	175	246	280	10	17	4	3	34.1	0.35	1.73	0.95	33.5	32328
	300	77	70	47	5	4	E31328J	7GB	674000	865000	1100	1500	162	167	254	280	8	26	4	3	-16.8	0.83	0.73	0.40	23.3	E31328J

Note: (°) Minus value of load center "a" indicates that the center is located outside of cone backface.

Tapered Roller Bearings
Metric Series

Bore Diameter: 150~180mm

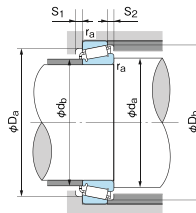
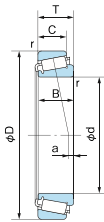

Dynamic equivalent radial load
 $P_r = XFr + YFa$

$\frac{F_a}{Fr} \leq e$		$\frac{F_a}{Fr} > e$	
X	Y	X	Y
1	0	0.4	Y ₁

Values e and Y₁ from table.

Static equivalent radial load

Larger value of following to be used:
 $P_{0r} = 0.5Fr + Y_0Fa$
 $P_{0r} = Fr$
Values Y₀ from table.

1N=0.102kgf

Boundary dimensions (mm)							Bearing No.	(Ref.) ISO355 Dimension series	Basic dynamic load rating Cr (N)	Basic static load rating Cor (N)	Limiting speed (min ⁻¹)		Abutment and fillet dimensions (mm)							Load center (mm) a (°)	Constant e	Axial load factor		Mass(kg) Reference	Bearing No.	
d	D	T	B	C	Cone r (min)	Cup r (min)					Grease lubrication	Oil lubrication	d _a (min)	d _b (max)	D _a (min)	D _b (min)	S ₁ (min)	S ₂ (min)	Cone r _a (max)			Cup r _a (max)	Y ₁			Y ₀
150	210	38	38	30	2.5	2	E32930J	2DC	286000	536000	1600	2100	162	163	194	202	7	8	2	2	1.9	0.33	1.83	1.01	3.96	E32930J
	225	48	48	36	3	2.5	E32030J	4EC	391000	668000	1500	2000	164	164	200	216	8	12	2.5	2	-0.8	0.46	1.31	0.72	6.41	E32030J
	270	49	45	38	4	3	E30230	—	466000	625000	1300	1800	168	175	234	255	9	11	3	2.5	-2.7	0.43	1.39	0.77	10.9	E30230
	270	77	73	60	4	3	E32230J	4GD	704000	1070000	1300	1800	168	170	226	254	8	17	3	2.5	11.8	0.44	1.38	0.76	18.2	E32230J
	320	72	65	46	5	4	30330D	—	616000	750000	970	1400	172	183	270	301	9	26	4	3	-24.0	0.81	0.74	0.41	23.9	30330D
	320	72	65	55	5	4	30330	—	717000	962000	1200	1500	172	193	272	292	12	17	4	3	10.2	0.35	1.73	0.95	25.4	30330
320	114	108	90	5	4	E32330	—	1240000	1790000	1200	1600	172	187	263	298	10	17	4	3	35.6	0.35	1.74	0.96	42.0	E32330	
160	220	38	38	30	2.5	2	E32932J	2DC	295000	568000	1500	2000	172	173	204	212	7	8	2	2	-0.4	0.35	1.73	0.95	4.19	E32932J
	240	51	51	38	3	2.5	E32032J	4EC	440000	758000	1400	1900	174	175	213	231	8	13	2.5	2	-1.1	0.46	1.31	0.72	7.75	E32032J
	290	52	48	40	4	3	30232	—	483000	637000	1200	1600	178	189	252	269	8	12	3	2.5	-5.4	0.46	1.31	0.72	13.3	30232
	290	84	80	67	4	3	E32232J	4GD	795000	1210000	1200	1700	178	182	242	274	10	17	3	2.5	13.7	0.44	1.38	0.76	23.2	E32232J
	340	75	68	48	5	4	30332D	—	742000	933000	900	1300	182	195	290	320	9	27	4	3	-26.8	0.81	0.74	0.41	29.1	30332D
	340	75	68	58	5	4	30332	—	793000	981000	1100	1400	182	205	289	310	12	17	4	3	11.5	0.35	1.73	0.95	28.7	30332
340	121	114	95	5	4	32332	—	1220000	1720000	1100	1400	182	200	277	316	10	18	4	3	38	0.35	1.73	0.95	47.9	32332	
170	230	38	38	34	2.5	2	E32934J	3DC	296000	606000	1400	1900	182	183	213	222	7	8	2	2	-4.0	0.38	1.57	0.86	4.49	E32934J
	260	57	57	43	3	2.5	E32034J	4EC	526000	905000	1300	1700	184	187	230	249	10	14	2.5	2	1.2	0.44	1.35	0.74	10.5	E32034J
	310	57	52	43	5	4	30234	—	544000	726000	1100	1500	192	202	269	288	8	4	4	3	-4.8	0.46	1.31	0.72	16.5	30234
	310	91	86	71	5	4	E32234J	4GD	1000000	1610000	1100	1500	192	195	259	294	11	20	4	3	16.1	0.44	1.38	0.76	28.8	E32234J
	360	80	72	50	5	4	30334D	—	762000	1040000	830	1200	192	211	310	333	9	30	4	3	-28.3	0.81	0.74	0.41	34.3	30334D
	360	80	72	62	5	4	30334	—	828000	1020000	1000	1300	192	218	306	329	13	18	4	3	12.3	0.35	1.73	0.95	33.0	30334
360	127	120	100	5	4	32334	—	1310000	1830000	1000	1300	192	200	295	337	14	26	4	3	40.9	0.35	1.73	0.95	55.8	32334	
180	250	45	45	34	2.5	2	E32936J	4DC	357000	735000	1300	1700	192	193	225	241	8	11	2	2	-8.5	0.48	1.25	0.69	6.64	E32936J
	280	64	64	48	3	2.5	E32036J	4EC	644000	1100000	1200	1600	194	199	247	268	10	16	2.5	2	4.5	0.42	1.42	0.78	14.1	E32036J
	320	57	52	43	5	4	E30236J	4GB	615000	870000	1100	1400	202	211	278	297	9	14	4	3	-6.6	0.45	1.33	0.73	18.3	E30236J
	320	91	86	71	5	4	E32236J	4GD	957000	1520000	1100	1500	202	204	267	303	10	20	4	3	13.2	0.45	1.33	0.73	29.9	E32236J
	380	83	75	52	5	4	30336D	—	833000	1150000	780	1100	202	225	330	351	10	31	4	3	-29.8	0.81	0.74	0.41	40.1	30336D
	380	83	75	64	5	4	30336	—	901000	1110000	940	1300	202	227	318	346	13	19	4	3	12	0.35	1.73	0.95	39.7	30336
380	134	126	105	5	4	32336	—	1410000	1980000	960	1300	202	215	310	355	14	27	4	3	42.2	0.35	1.73	0.95	67.0	32336	

Note: (°) Minus value of load center "a" indicates that the center is located outside of cone backface.

Tapered Roller Bearings
Metric Series

Bore Diameter: 190~260mm

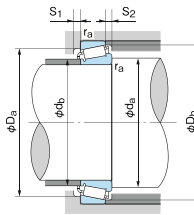
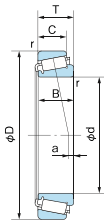

Dynamic equivalent radial load
 $F_r = XFr + YFa$

X	Y	$\frac{F_a}{F_r} \leq e$		$\frac{F_a}{F_r} > e$	
		1	0	0.4	Y ₁
1	0	0.4	0	0.4	Y ₁

Values e and Y₁ from table.

Static equivalent radial load

Larger value of following to be used:
 $P_{0r} = 0.5Fr + Y_0Fa$
 $P_{0r} = Fr$
 Values Y₀ from table.

1N=0.102kgf

Boundary dimensions (mm)								Bearing No.	(Ref.) ISO355 Dimension series	Basic dynamic load rating Cr (N)	Basic static load rating Cor (N)	Limiting speed (min ⁻¹)		Abutment and fillet dimensions (mm)								Load center (mm) a (°)	Constant e	Axial load factor		Mass(kg) Reference	Bearing No.
d	D	T	B	C	Cone r (min)	Cup r (min)	Grease lubrication					Oil lubrication	da (min)	db (max)	Da (min)	Db (min)	S ₁ (min)	S ₂ (min)	Cone ra (max)	Cup	Y ₁			Y ₀			
190	260	45	45	34	2.5	2	E32938J	4DC	366000	789000	1200	1600	202	204	235	252	8	11	2	2	-10.0	0.48	1.26	0.69	6.89	E32938J	
	290	64	64	48	3	2.5	E32038J	4FD	654000	1170000	1100	1500	204	209	257	279	10	16	2.5	2	1.1	0.44	1.36	0.75	14.7	E32038J	
	340	60	55	46	5	4	E30238J	4GB	729000	1030000	1000	1400	212	225	298	318	12	13	4	3	-6.4	0.44	1.38	0.76	21.9	E30238J	
	340	97	92	75	5	4	E32238J	4GD	1090000	1740000	1000	1400	208	216	290	330	6	12	4	3	15	0.46	1.31	0.72	33.9	E32238J	
	400	86	78	52	6	5	30338D	—	950000	1210000	740	1000	218	232	350	372	11	34	5	4	-33.2	0.81	0.74	0.41	44.8	30338D	
	400	86	78	65	5	5	30338	—	1010000	1250000	880	1200	218	241	342	370	10	20	5	4	12.8	0.35	1.73	0.95	46.2	30338	
400	140	132	109	5	5	32338	—	1550000	2190000	890	1200	218	225	330	375	14	30	5	4	43.5	0.35	1.73	0.95	76.6	32338		
200	280	51	51	39	3	2.5	E32940J	3EC	486000	958000	1100	1500	214	216	257	271	9	12	2.5	2	-2.6	0.39	1.52	0.84	9.44	E32940J	
	310	70	70	53	3	2.5	E32040J	4FD	755000	1340000	1100	1400	214	221	273	297	11	17	2.5	2	3.1	0.43	1.39	0.77	19.1	E32040J	
	360	64	58	48	5	4	E30240J	4GB	792000	1120000	940	1200	222	238	315	336	12	15	4	3	-6.3	0.44	1.38	0.76	26.4	E30240J	
	360	104	98	82	5	4	E32240J	4GD	1240000	1880000	960	1300	222	225	302	340	11	22	4	3	19.4	0.41	1.48	0.81	44.2	E32240J	
	420	89	80	56	6	5	30340D	—	904000	1230000	690	970	228	248	365	385	11	33	5	4	-33.6	0.81	0.74	0.41	50.6	30340D	
	420	89	80	67	5	5	30340	—	1120000	1450000	820	1100	228	255	354	385	11	21	5	4	9.2	0.35	1.73	0.95	53.5	30340	
420	146	138	115	5	5	32340	—	1790000	2580000	830	1100	228	240	345	395	16	30	5	4	43.1	0.35	1.73	0.95	91.0	32340		
220	300	51	51	39	3	2.5	E32944J	3EC	498000	1010000	1000	1400	234	234	275	290	9	12	2.5	2	-7.6	0.43	1.41	0.78	10.1	E32944J	
	340	76	76	57	4	3	E32044J	4FD	894000	1620000	940	1300	238	243	300	326	12	19	3	2.5	3.2	0.43	1.39	0.77	25.2	E32044J	
	400	72	65	54	5	4	E30244J	—	1010000	1440000	830	1100	242	263	344	371	14	17	4	3	-4.5	0.44	1.43	0.79	35.9	E30244J	
	400	114	108	90	5	4	32244	—	1190000	1930000	830	1100	242	260	333	377	16	14	4	3	18.1	0.43	1.39	0.77	56.8	32244	
	460	97	88	73	5	5	30344	—	1260000	1680000	730	980	248	282	386	420	12	23	5	4	12.4	0.35	1.73	0.95	69.0	30344	
	460	154	145	122	5	5	32344	—	2100000	3170000	750	1000	242	267	375	423	10	18	5	4	43	0.35	1.73	0.95	108	32344	
240	320	51	51	39	3	2.5	E32948J	4EC	515000	1090000	940	1300	254	254	294	311	9	12	2.5	2	-13.5	0.46	1.31	0.72	10.9	E32948J	
	360	76	76	57	4	3	E32048J	4FD	924000	1720000	870	1300	258	261	318	346	12	19	3	2.5	-2.5	0.46	1.31	0.72	26.8	E32048J	
	440	79	72	60	5	4	E30248	—	1230000	1790000	730	980	262	287	377	409	14	18	4	3	-3.7	0.42	1.43	0.79	49.5	E30248	
	440	127	120	100	5	4	E32248	—	1830000	3010000	740	980	262	282	365	415	16	14	4	3	22	0.44	1.38	0.76	80	E32248	
	500	105	95	80	5	5	30348	—	1520000	2100000	670	890	268	308	414	445	16	21	5	4	13.3	0.35	1.73	0.95	87.3	30348	
	500	165	155	132	5	5	32348	—	2510000	3870000	670	890	268	298	413	461	16	20	5	4	47.6	0.35	1.73	0.95	144	32348	
260	360	63.5	63.5	48	3	2.5	E32952J	—	741000	1550000	830	1100	274	279	328	347	11	15.5	2.5	2	-6.1	0.41	1.48	0.81	18.9	E32952J	
	400	87	87	65	5	4	E32052J	—	1170000	2170000	770	1000	282	287	352	383	14	22	4	3	2.0	0.43	1.38	0.76	39.5	E32052J	
	480	89	80	67	6	5	30252	—	1210000	1860000	650	870	288	310	415	450	14	21	5	4	-4.6	0.42	1.44	0.79	64.9	30252	
	480	137	130	106	6	5	32252	—	1760000	2870000	660	880	288	300	400	455	16	30	5	4	21.8	0.43	1.39	0.77	102	32252	

Note: (°) Minus value of load center "a" indicates that the center is located outside of cone backface.

Tapered Roller Bearings
Metric Series

Bore Diameter: 280~320mm

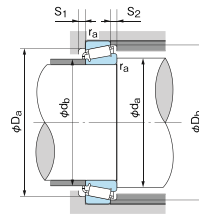
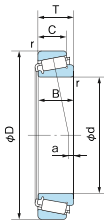

■ Dynamic equivalent radial load

$F_r = XFr + YFa$

	$\frac{F_a}{F_r} \leq e$	$\frac{F_a}{F_r} > e$
X	Y	X
1	0	0.4
		Y_1

Values e and Y_1 from table.

■ Static equivalent radial load

Larger value of following to be used:
 $P_0 = 0.5Fr + Y_0Fa$
 $P_0 = Fr$
 Values Y_0 from table.

1N=0.102kgf

d	Boundary dimensions (mm)					Cone r (min)	Cup	Bearing No.	(Ref.) ISO355 Dimension series	Basic dynamic load rating Cr (N)	Basic static load rating Cor (N)	Limiting speed (min ⁻¹)		Abutment and fillet dimensions (mm)								Load center (mm) a (°)	Constant e	Axial load factor		Mass(kg) Reference	Bearing No.
	D	T	B	C	Grease lubrication							Oil lubrication	da (min)	db (max)	Da (min)	Db (min)	S1 (min)	S2 (min)	Cone ra (max)	Cup	Y1			Y0			
280	380	63.5	63.5	48	3	2.5	E32956J	4EC	760000	1630000	770	1000	294	298	347	368	11	15.5	2.5	2	-11.6	0.43	1.39	0.76	20.1	E32956J	
	420	87	87	65	5	4	E32056J	4FC	1200000	2280000	720	960	302	305	370	405	14	22	4	3	-4.1	0.46	1.31	0.72	41.7	E32056J	
	500	89	80	67	6	5	30256	—	1260000	1920000	610	810	308	325	440	475	14	21	5	4	-7.2	0.42	1.44	0.79	67.6	30256	
	500	137	130	106	6	5	32256	—	1860000	3150000	610	810	308	325	420	474	16	30	5	4	19.8	0.43	1.39	0.77	108.0	32256	
300	420	76	76	57	4	3	E32960J	3FD	1050000	2210000	680	910	318	324	383	405	12	19	3	2.5	-3.9	0.39	1.52	0.84	32.4	E32960J	
	460	100	100	74	5	4	E32060J	4GD	1430000	2660000	640	850	322	329	404	439	15	26	4	3	2.1	0.43	1.38	0.76	57.5	E32060J	
	540	96	85	71	6	5	30260	—	1510000	2360000	550	730	328	350	475	505	14	24	5	4	-7.9	0.42	1.44	0.79	84.7	30260	
	540	149	140	115	6	5	32260	—	2310000	4060000	570	780	322	343	456	510	6	15	5	4	17	0.47	1.27	0.70	132	32260	
320	440	76	76	57	4	3	E32964J	3FD	1060000	2270000	640	850	338	342	401	426	12	19	3	2.5	-9.0	0.42	1.44	0.79	34.0	E32964J	
	480	100	100	74	5	4	E32064J	4GD	1510000	2810000	600	800	342	344	418	461	16	26	4	3	-3.0	0.46	1.31	0.72	58.7	E32064J	
	580	104	92	75	6	5	30264	—	1740000	2770000	490	660	348	370	505	540	14	28	5	4	-7.9	0.42	1.44	0.79	108	30264	

Note: (°) Minus value of load center "a" indicates that the center is located outside of cone backface.

Tapered Roller Bearings
Inch Series
Bore Diameter: 15.875~30.163mm

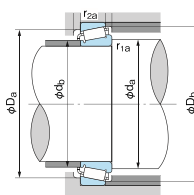
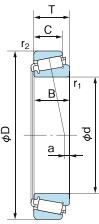

■ Dynamic equivalent radial load
 $F_r = XFr + YFa$

$\frac{F_a}{F_r} \leq e$		$\frac{F_a}{F_r} > e$	
X	Y	X	Y
1	0	0.4	Y_1

Values e and Y_1 from table.

■ Static equivalent radial load
Larger value of following to be used:
 $P_{or} = 0.5Fr + Y_0Fa$
 $P_{or} = Fr$
Values Y_0 from table.

Boundary dimensions (mm)							Bearing No.		Basic load rating		Limiting speed (min ⁻¹)		Abutment and fillet dimensions (mm)						Load center (mm)	Constant	Axial load factor		Mass(kg) Reference		Bearing No.					
d	D	T	B	C	r ₁ (min)	r ₂ (min)	Cone	Cup	Cr (kN)	Cor (kN)	Grease	Oil	d _s	d _b	D _a	D _b	r _{1a}	r _{2a}	a (1)	e	Y ₁	Y ₀	Cone	Cup	Cone	Cup	Cone	Cup		
15.875	42.863	14.288	14.288	9.525	1.60	1.60	H-11590	H-11520	17.8	17.7	10000	14000	24.5	22.5	34.5	39.5	1.60	1.60	1.2	0.70	0.85	0.47	0.06	0.04	H-11590	H-11520				
17.463	39.878	13.843	14.605	10.668	1.20	1.20	H-LM11749R	H-LM11710	25.4	26.0	11000	14000	23.0	21.5	34.0	37.0	1.20	1.20	5.2	0.29	2.10	1.15	0.058	0.028	H-LM11749R	H-LM11710				
19.050	45.237	15.494	16.637	12.065	1.20	1.20	H-LM11949	H-LM11910	29.4	30.1	9400	13000	25.0	23.5	39.5	41.5	1.20	1.20	5.5	0.30	2.00	1.10	0.081	0.044	H-LM11949	H-LM11910				
	49.225	18.034	19.050	14.288	1.20	1.20	H-09067	H-09195	37.7	37.7	8900	12000	25.5	24.0	42.0	44.5	1.20	1.20	7.4	0.27	2.26	1.24	0.114	0.065	H-09067	H-09195				
	53.975	22.225	21.839	15.875	1.57	2.36	H-21075	H-21212	42	41.2	8400	11000	31.5	26.0	43.0	50.0	1.57	2.36	5.6	0.59	1.02	0.56	0.159	0.095	H-21075	H-21212				
21.430	50.005	17.526	18.288	13.970	1.17	1.17	H-M12649	H-M12610	39.1	40.7	8500	11000	27.5	25.5	44.0	46.0	1.17	1.17	6.4	0.28	2.16	1.19	0.119	0.058	H-M12649	H-M12610				
21.987	45.237	15.494	16.637	12.065	1.27	1.27	H-LM12749	H-LM12710	30.1	34.6	8900	12000	27.5	26.0	39.5	42.0	1.27	1.27	5.5	0.31	1.96	1.08	0.078	0.038	H-LM12749	H-LM12710				
	45.975	15.494	16.637	12.065	1.27	1.27	H-LM12749	H-LM12711	30.1	34.6	8900	12000	27.5	26.0	40.0	42.5	1.27	1.27	5.5	0.31	1.96	1.08	0.078	0.043	H-LM12749	H-LM12711				
	52.388	19.368	20.168	14.288	1.60	1.60	H-1380	H-1328	36.7	37.9	8000	11000	29.5	29.5	45.0	48.5	1.60	1.60	7.7	0.29	2.05	1.13	0.132	0.066	H-1380	H-1328				
22.225	56.896	19.368	19.837	15.875	1.20	1.20	H-1755	H-1729	40.0	43.1	7600	10000	29.0	27.5	49.0	51.0	1.20	1.20	7.1	0.31	1.95	1.07	0.150	0.100	H-1755	H-1729				
	57.150	22.225	22.225	17.463	0.80	1.60	H-1280	H-1220	52.6	55.7	7600	10000	29.5	29.0	49.0	52.0	0.80	1.60	7.9	0.35	1.73	0.95	0.189	0.105	H-1280	H-1220				
23.812	56.896	19.368	19.837	15.875	0.80	1.20	H-1779	H-1729	40.0	43.1	7600	10000	29.5	28.5	49.0	51.0	0.80	1.20	7.1	0.31	1.95	1.07	0.141	0.100	H-1779	H-1729				
	50.292	14.224	14.732	10.668	1.20	1.20	H-L44643R	H-L44610	31.2	37.0	7800	10000	31.5	29.5	44.5	47.0	1.20	1.20	3.2	0.37	1.60	0.88	0.092	0.039	H-L44643R	H-L44610				
	57.150	19.431	19.431	14.732	1.57	1.57	H-M84548	H-M84510	42.2	49.2	7300	9700	36.0	33.0	48.5	54.0	1.57	1.57	3.4	0.55	1.10	0.60	0.156	0.088	H-M84548	H-M84510				
25.400	61.999	19.050	20.638	14.288	3.60	1.20	H-15100	H-15245	44.6	50.7	6400	8600	38.0	31.5	55.0	58.0	3.60	1.20	5.7	0.35	1.71	0.94	0.215	0.081	H-15100	H-15245				
	61.999	19.050	20.638	14.288	0.80	1.20	H-15101	H-15245	44.6	50.7	6400	8600	32.5	31.5	55.0	58.0	0.80	1.20	5.7	0.35	1.71	0.94	0.215	0.081	H-15101	H-15245				
	64.292	21.433	21.433	16.670	1.57	1.57	H-M86643R	H-M86610	55.2	70.7	6400	8500	38.0	36.5	54.0	61.0	1.57	1.57	3.4	0.55	1.10	0.60	0.248	0.127	H-M86643R	H-M86610				
	65.088	22.225	21.463	15.875	1.60	1.60	H-23100	H-23256	47.8	51.7	5600	7900	39.0	34.5	53.0	61.0	1.60	1.60	2.2	0.73	0.82	0.45	0.231	0.141	H-23100	H-23256				
26.157	61.913	19.050	20.638	14.288	0.80	2.00	H-15103	H-15243	44.6	50.7	6400	8600	33.0	32.5	55.0	58.0	0.80	2.00	5.7	0.35	1.71	0.94	0.213	0.079	H-15103	H-15243				
	61.999	19.050	20.638	14.288	0.80	1.20	H-15103	H-15245	44.6	50.7	6400	8600	33.0	32.5	55.0	58.0	0.80	1.20	5.7	0.35	1.71	0.94	0.213	0.081	H-15103	H-15245				
	50.292	14.224	14.732	10.668	3.60	1.20	H-L44649R	H-L44610	31.2	37	7800	10000	37.5	31.0	44.5	47.0	3.60	1.20	3.2	0.37	1.60	0.88	0.083	0.039	H-L44649R	H-L44610				
26.988	61.999	19.050	20.638	14.288	0.80	1.20	H-15106	H-15245	44.6	50.7	6400	8600	33.5	33.0	55.0	58.0	0.80	1.20	5.7	0.35	1.71	0.94	0.206	0.081	H-15106	H-15245				
	63.500	20.638	20.638	15.875	0.80	1.20	H-15106	H-15250	44.6	50.7	6400	8600	33.5	33.0	56.0	59.0	0.80	1.20	5.7	0.35	1.71	0.94	0.206	0.112	H-15106	H-15250				
	63.500	20.638	20.638	15.875	0.80	1.60	H-15106	H-15250X	44.6	50.7	6400	8600	33.5	33.0	55.0	59.0	0.80	1.60	5.7	0.35	1.71	0.94	0.206	0.111	H-15106	H-15250X				
	57.150	19.845	19.355	15.875	3.60	1.60	H-1988R	H-1922	48.8	57.1	7000	9300	39.5	33.5	51.0	53.5	3.60	1.60	5.9	0.33	1.82	1.00	0.151	0.076	H-1988R	H-1922				
	61.999	19.050	20.638	14.288	3.60	1.20	H-15112	H-15245	44.6	50.7	6400	8600	40.0	34.0	55.0	58.0	3.60	1.20	5.7	0.35	1.71	0.94	0.193	0.081	H-15112	H-15245				
28.575	63.500	20.638	20.638	15.875	3.60	1.20	H-15112	H-15250	44.6	50.7	6400	8600	40.0	34.0	56.0	59.0	3.60	1.20	5.7	0.35	1.71	0.94	0.193	0.112	H-15112	H-15250				
	64.292	21.433	21.433	16.670	1.60	1.60	H-M86647R	H-M86610	55.2	70.7	6400	8500	40.0	38.0	54.0	61.0	1.60	1.60	3.4	0.55	1.10	0.60	0.225	0.127	H-M86647R	H-M86610				
	68.263	22.225	22.225	17.463	0.80	1.60	H-02474	H-02420	51.0	61.1	6000	8000	36.5	36.0	59.0	63.0	0.80	1.60	5.1	0.42	1.44	0.79	0.252	0.150	H-02474	H-02420				
	73.025	22.225	22.225	17.463	0.80	3.20	H-02872	H-02820	55.0	65.7	5500	7400	37.5	37.0	62.0	68.0	0.80	3.20	3.7	0.45	1.32	0.73	0.319	0.158	H-02872	H-02820				
	29.000	50.292	14.224	14.732	10.668	3.60	1.27	H-L45449	H-L45410	28.9	37.2	7600	10000	39.5	33.0	44.5	48.0	3.60	1.27	3.3	0.37	1.62	0.89	0.079	0.036	H-L45449	H-L45410			
29.987	61.999	19.050	20.638	14.288	1.20	1.20	H-15117	H-15245	44.6	50.7	6400	8600	36.5	35.0	55.0	58.0	1.20	1.20	5.7	0.35	1.71	0.94	0.184	0.081	H-15117	H-15245				
30.000	72.085	22.385	19.202	18.415	0.80	2.40	H-14118	H-14283	46.1	55	5900	7800	37.0	36.5	60.0	65.0	0.80	2.40	4.4	0.38	1.57	0.86	0.224	0.21	H-14118	H-14283				
30.163	64.292	21.433	21.433	16.670	1.57	1.57	H-M86649R	H-M86610	55.2	70.7	6400	8500	41.0	38.0	54.0	61.0	1.57	1.57	3.4	0.55	1.10	0.60	0.213	0.127	H-M86649R	H-M86610				
	68.263	22.225	22.225	17.463	2.40	1.60	H-M88043	H-M88010	56.1	71.1	6000	7900	43.5	39.5	58.0	65.0	2.40	1.60	3.0	0.55	1.10	0.60	0.258	0.144	H-M88043	H-M88010				

Note: (1) Minus value of load center "a" indicates that the center is located outside of cone backface.

Tapered Roller Bearings
Inch Series
Bore Diameter: 30.213~33.338mm

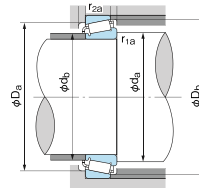
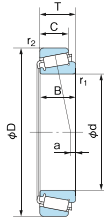

■ Dynamic equivalent radial load
 $F_r = XFr + YFa$

$\frac{F_a}{F_r} \leq e$		$\frac{F_a}{F_r} > e$	
X	Y	X	Y
1	0	0.4	Y_1

Values e and Y_1 from table.

■ Static equivalent radial load

Larger value of following to be used:
 $P_0 = 0.5Fr + Y_0Fa$
 $P_0 = Fr$
Values Y_0 from table.

Boundary dimensions (mm)						Bearing No.		Basic load rating		Limiting speed (min ⁻¹)		Abutment and fillet dimensions (mm)						Load center (mm)	Constant e	Axial load factor		Mass(kg) Reference		Bearing No.				
d	D	T	B	C	r ₁ (min)	r ₂ (min)	Cone	Cup	Cr (kN)	Cor (kN)	Grease	Oil	d _a	d _b	D _a	D _b	r _{1a}	r _{2a}	a	e	Y ₁	Y ₀	Cone	Cup	Cone	Cup	Cone	Cup
30.213	61.999	19.050	20.638	14.288	3.60	1.20	H-15118	H-15245	44.6	50.7	6400	8600	41.5	35.5	55.0	58.0	3.60	1.20	5.7	0.35	1.71	0.94	0.181	0.081	H-15118	H-15245		
	61.999	19.050	20.638	14.288	0.80	1.20	H-15120	H-15245	44.6	50.7	6400	8600	36.0	35.5	55.0	58.0	0.80	1.20	5.7	0.35	1.71	0.94	0.183	0.081	H-15120	H-15245		
	63.500	20.638	20.638	15.875	3.60	1.20	H-15118	H-15250	44.6	50.7	6400	8600	41.5	35.5	56.0	59.0	3.60	1.20	5.7	0.35	1.71	0.94	0.181	0.112	H-15118	H-15250		
	63.500	20.638	20.638	15.875	3.60	1.60	H-15118	H-15250X	44.6	50.7	6400	8600	41.5	35.5	55.0	59.0	3.60	1.60	5.7	0.35	1.71	0.94	0.181	0.111	H-15118	H-15250X		
30.226	69.012	19.845	19.583	15.875	0.80	1.20	H-14116	H-14276	46.1	55	5900	7800	37.0	36.5	60.0	63.0	0.80	1.20	4.4	0.38	1.57	0.86	0.226	0.134	H-14116	H-14276		
31.750	59.131	15.875	16.764	11.811	SP	1.20	H-LM67048	H-LM67010	35.8	43.1	6600	8800	42.5	36.0	52.0	56.0	SP	1.20	2.9	0.41	1.46	0.80	0.120	0.062	H-LM67048	H-LM67010		
	61.999	18.161	19.050	14.288	SP	1.20	H-15123	H-15245	44.6	50.7	6400	8600	42.5	36.5	55.0	58.0	SP	1.20	4.8	0.35	1.71	0.94	0.157	0.081	H-15123	H-15245		
	61.999	19.050	20.638	14.288	3.60	1.20	H-15125	H-15245	44.6	50.7	6400	8600	42.5	36.5	55.0	58.0	3.60	1.20	5.7	0.35	1.71	0.94	0.169	0.081	H-15125	H-15245		
	61.999	19.050	20.638	14.288	0.80	1.20	H-15126	H-15245	44.6	50.7	6400	8600	37.0	36.5	55.0	58.0	0.80	1.20	5.7	0.35	1.71	0.94	0.171	0.081	H-15126	H-15245		
	66.421	25.400	25.357	20.638	0.80	3.20	H-2580	H-2520	71.4	85.1	6000	8000	38.5	37.5	57.0	62.5	0.80	3.20	9.4	0.27	2.19	1.21	0.281	0.123	H-2580	H-2520		
	68.263	22.225	22.225	17.463	3.60	1.60	H-02475	H-02420	51.0	61.1	6000	8000	44.5	38.5	59.0	63.0	3.60	1.60	5.1	0.42	1.44	0.79	0.224	0.150	H-02475	H-02420		
	68.263	22.225	22.225	17.463	1.60	1.60	H-M88046	H-M88010	56.1	71.1	6000	7900	43.0	40.5	58.0	65.0	1.60	1.60	3.0	0.55	1.10	0.60	0.245	0.144	H-M88046	H-M88010		
	69.012	19.845	19.583	15.875	3.60	1.20	H-14125A	H-14276	46.1	55	5900	7800	44.0	37.5	60.0	63.0	3.60	1.20	4.4	0.38	1.57	0.86	0.213	0.134	H-14125A	H-14276		
	69.012	19.845	19.583	15.875	3.60	3.20	H-14125A	H-14274	46.1	55	5900	7800	44.0	37.5	59.0	63.0	3.60	3.20	4.4	0.38	1.57	0.86	0.213	0.131	H-14125A	H-14274		
	69.850	23.813	25.357	19.050	0.80	1.20	H-2580	H-2523	71.4	85.1	6000	8000	38.5	37.5	61.0	64.0	0.80	1.20	9.4	0.27	2.19	1.21	0.281	0.168	H-2580	H-2523		
33.338	68.263	22.225	22.225	17.463	0.80	1.60	H-M88048	H-M88010	56.1	71.1	6000	7900	42.5	41.0	58.0	65.0	0.80	1.60	3.0	0.55	1.10	0.60	0.231	0.144	H-M88048	H-M88010		
	69.012	19.845	19.583	15.875	3.60	1.20	H-14130	H-14276	46.1	55.0	5900	7800	45.0	38.5	60.0	63.0	3.60	1.20	4.4	0.38	1.57	0.86	0.2	0.134	H-14130	H-14276		
	69.012	19.845	19.583	15.875	0.80	3.20	H-14131	H-14274	46.1	55.0	5900	7800	39.5	38.5	59.0	63.0	0.80	3.20	4.4	0.38	1.57	0.86	0.203	0.131	H-14131	H-14274		
	69.012	19.845	19.583	15.875	0.80	1.20	H-14131	H-14276	46.1	55.0	5900	7800	39.5	38.5	60.0	63.0	0.80	1.20	4.4	0.38	1.57	0.86	0.203	0.134	H-14131	H-14276		
	69.012	19.845	19.583	15.875	3.60	3.20	H-14130	H-14274	46.1	55.0	5900	7800	45.0	38.5	59.0	63.0	3.60	3.20	4.4	0.38	1.57	0.86	0.2	0.131	H-14130	H-14274		
	76.200	23.813	25.654	19.050	1.60	3.20	H-2790R	H-2720	74.1	92.2	5400	7200	42.0	40.0	66.0	70.0	1.60	3.20	8.1	0.30	1.98	1.09	0.364	0.184	H-2790R	H-2720		

Notes: (1) Minus value of load center "a" indicates that the center is located outside of cone backface.
(2) SP indicates special surface handling configurations.

Tapered Roller Bearings
Inch Series
Bore Diameter: 34.925~38.100mm

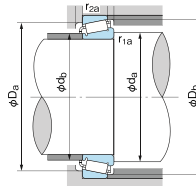
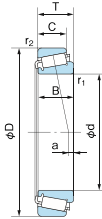

■ Dynamic equivalent radial load
 $F_r = XFr + YFa$

$\frac{F_a}{F_r} \leq e$		$\frac{F_a}{F_r} > e$	
X	Y	X	Y
1	0	0.4	Y_1

Values e and Y_1 from table.

■ Static equivalent radial load
Larger value of following to be used:
 $P_{or} = 0.5Fr + Y_0Fa$
 $P_{or} = Fr$
Values Y_0 from table.

1N=0.102kgf

Boundary dimensions (mm)							Bearing No.		Basic load rating		Limiting speed (min ⁻¹)		Abutment and fillet dimensions (mm)						Load center (mm)	Constant	Axial load factor		Mass(kg) Reference		Bearing No.	
d	D	T	B	C	r ₁ (min)	r ₂ (min)	Cone	Cup	Cr (kN)	Cor (kN)	Grease	Oil	d _s	d _b	D _a	D _b	r _{1a}	r _{2a}	a (°)	e	Y ₁	Y ₀	Cone	Cup	Cone	Cup
34.925	65.088	18.034	18.288	13.970	SP	1.20	H-LM48548	H-LM48510	48.0	58.5	6000	8000	46.0	40.0	58.0	61.0	SP	1.20	3.7	0.38	1.59	0.88	0.164	0.086	H-LM48548	H-LM48510
	65.088	21.082	18.288	17.018	SP	1.60	H-LM48548A	H-LM48511A	48.0	58.5	6000	8000	46.0	40.0	58.0	61.0	SP	1.60	3.7	0.38	1.59	0.88	0.164	0.113	H-LM48548A	H-LM48511A
	65.088	18.034	18.288	13.970	0.80	1.20	H-LM48548A	H-LM48510	48.0	58.5	6000	8000	40.5	42.0	58.0	61.0	0.80	1.20	3.7	0.38	1.59	0.88	0.169	0.086	H-LM48548A	H-LM48510
	65.088	21.082	18.288	17.018	0.80	1.60	H-LM48548A	H-LM48511A	48.0	58.5	6000	8000	40.5	42.0	58.0	61.0	0.80	1.60	3.7	0.38	1.59	0.88	0.169	0.113	H-LM48548A	H-LM48511A
	69.012	19.845	19.583	15.875	1.60	3.20	H-14137A	H-14274	46.1	55.0	5900	7800	42.0	40.0	59.0	63.0	1.60	3.20	4.4	0.38	1.57	0.86	0.189	0.131	H-14137A	H-14274
	69.012	19.845	19.583	15.875	1.60	1.20	H-14137A	H-14276	46.1	55.0	5900	7800	42.0	40.0	60.0	63.0	1.60	1.20	4.4	0.38	1.57	0.86	0.189	0.134	H-14137A	H-14276
	69.012	19.845	19.583	15.875	3.60	3.20	H-14138A	H-14274	46.1	55.0	5900	7800	46.0	40.0	59.0	63.0	3.60	3.20	4.4	0.38	1.57	0.86	0.187	0.131	H-14138A	H-14274
	69.012	19.845	19.583	15.875	3.60	1.20	H-14138A	H-14276	46.1	55.0	5900	7800	46.0	40.0	60.0	63.0	3.60	1.20	4.4	0.38	1.57	0.86	0.187	0.134	H-14138A	H-14276
	72.233	25.400	25.400	19.842	2.40	2.40	H-HM8649	H-HM8610	68.9	87.4	5700	7600	48.5	42.5	60.0	69.0	2.40	2.40	4.7	0.55	1.10	0.60	0.301	0.185	H-HM8649	H-HM8610
	73.025	23.813	24.608	19.050	1.60	2.40	H-25877R	H-25820	72.2	87.3	5600	7400	43.0	40.5	64.0	68.0	1.60	2.40	8.2	0.29	2.07	1.14	0.31	0.165	H-25877R	H-25820
	73.025	23.813	24.608	19.050	1.60	0.80	H-25877R	H-25821	72.2	87.3	5600	7400	43.0	40.5	65.0	68.0	1.60	0.80	8.2	0.29	2.07	1.14	0.31	0.165	H-25877R	H-25821
	76.200	29.370	28.575	23.813	3.60	3.30	H-31593	H-31520	80.9	97.4	5400	7200	50.0	43.5	64.0	72.0	3.60	3.30	7.8	0.40	1.49	0.82	0.388	0.232	H-31593	H-31520
	76.200	29.370	28.575	23.813	1.60	3.30	H-31594	H-31520	80.9	97.4	5400	7200	46.0	43.5	64.0	72.0	1.60	3.30	7.8	0.40	1.49	0.82	0.388	0.232	H-31594	H-31520
	79.375	29.370	29.771	23.813	3.60	3.20	3478	3420	87.4	105	5200	6900	50.0	43.5	67.0	74.0	3.60	3.20	8.6	0.37	1.64	0.90	0.462	0.256	3478	3420
	80.167	29.370	30.391	23.813	3.60	3.20	3379	3320	91	106	5000	6700	48.0	41.5	70.0	75.0	3.60	3.20	10.7	0.27	2.20	1.21	0.505	0.217	3379	3320
	85.725	30.162	30.162	23.813	3.60	3.20	3872	3820	108	136	4800	6400	53.0	46.0	73.0	81.0	3.60	3.20	8.4	0.40	1.49	0.82	0.614	0.285	3872	3820
34.987	59.131	15.875	16.764	11.938	SP	1.27	H-L68149	H-L68110	35.7	48.5	6400	8500	45.5	39.0	53.0	56.0	SP	1.27	2.7	0.42	1.44	0.79	0.112	0.056	H-L68149	H-L68110
	59.975	15.875	16.764	11.938	SP	1.20	H-L68149	H-L68111	35.7	48.5	6400	8500	45.5	39.0	53.0	56.0	SP	1.20	2.7	0.42	1.44	0.79	0.112	0.063	H-L68149	H-L68111
	73.025	23.813	24.608	19.050	1.60	2.40	H-25880R	H-25820	72.2	87.3	5600	7400	44.0	42.0	64.0	68.0	1.60	2.40	8.2	0.29	2.07	1.14	0.294	0.164	H-25880R	H-25820
36.487	73.025	23.813	24.608	19.050	1.60	0.80	H-25880R	H-25821	72.2	87.3	5600	7400	44.0	42.0	65.0	68.0	1.60	0.80	8.2	0.29	2.07	1.14	0.294	0.165	H-25880R	H-25821
	76.200	23.813	25.654	19.050	1.60	3.20	H-2780R	H-2720	74.1	92.2	5400	7200	44.5	42.5	66.0	70.0	1.60	3.20	8.1	0.30	1.98	1.09	0.33	0.185	H-2780R	H-2720
36.513	76.200	29.370	28.575	23.813	3.60	3.30	H-31597	H-31520	80.9	97.4	5400	7200	51.0	44.5	64.0	72.0	3.60	3.30	7.8	0.40	1.49	0.82	0.368	0.232	H-31597	H-31520
	93.663	31.750	31.750	26.195	1.60	3.20	46143	46368	105	134	4400	5800	48.5	46.5	79.0	87.0	1.60	3.20	7.7	0.40	1.49	0.82	0.738	0.403	46143	46368
38.000	63.000	17.000	17.000	13.500	SP	SP	H-JL69349	H-JL69310	43.5	58.2	6000	8000	49.0	41.0	60.0	56.5	SP	SP	2.4	0.42	1.44	0.79	0.128	0.070	H-JL69349	H-JL69310
38.100	65.088	18.034	18.288	13.970	SP	1.17	H-LM29748	H-LM29710	42.9	56.5	5800	7800	49.0	42.5	59.0	62.0	SP	1.17	4.3	0.33	1.80	0.99	0.154	0.079	H-LM29748	H-LM29710
	65.088	18.034	18.288	13.970	2.36	1.17	H-LM29749	H-LM29710	42.9	56.5	5800	7800	46.0	42.5	59.0	62.0	2.36	1.17	4.3	0.33	1.80	0.99	0.159	0.079	H-LM29749	H-LM29710
	65.088	19.812	18.288	15.748	2.36	1.30	H-LM29749	H-LM29711	42.9	56.5	5800	7800	46.0	42.5	58.0	62.0	2.36	1.30	4.3	0.33	1.80	0.99	0.159	0.092	H-LM29749	H-LM29711
	68.275	20.000	16.520	16.032	1.60	1.60	H-19150R	H-19268X	46.1	53.8	5700	7600	45.0	43.0	61.0	65.0	1.60	1.60	1.4	0.44	1.35	0.74	0.167	0.109	H-19150R	H-19268X
	69.012	26.195	26.195	15.083	1.60	2.40	H-13686	H-13621	49.2	62	5600	7500	46.0	43.0	61.0	65.0	1.60	2.40	10.1	0.40	1.49	0.82	0.254	0.102	H-13686	H-13621
	76.200	23.813	25.654	19.050	3.60	3.20	H-2788R	H-2720	74.1	92.2	5400	7200	50.0	43.5	66.0	70.0	3.60	3.20	8.1	0.30	1.98	1.09	0.308	0.185	H-2788R	H-2720
	79.375	23.813	25.400	19.050	0.80	0.80	H-26878R	H-26822	81.1	105	5000	6700	45.0	44.5	71.0	74.0	0.80	0.80	7.5	0.32	1.88	1.04	0.397	0.185	H-26878R	H-26822
	79.375	29.370	29.771	23.813	3.60	3.20	3490	3420	87.4	105	5200	6900	52.0	45.9	67.0	74.0	3.60	3.20	8.6	0.37	1.64	0.90	0.421	0.256	3490	3420
	80.167	25.400	25.400	20.638	0.80	3.20	H-26878R	H-26820	81.1	105	5000	6700	45.0	44.5	69.0	74.0	0.80	3.20	7.5	0.32	1.88	1.04	0.397	0.217	H-26878R	H-26820
	88.501	26.988	29.083	22.225	3.60	1.60	418	414	98.2	112	4900	6500	51.0	44.5	77.0	80.0	3.60	1.60	10.1	0.26	2.28	1.25	0.523	0.325	418	414

Notes: (1) Minus value of load center "a" indicates that the center is located outside of cone backface.
(2) SP indicates special surface handling configurations.

Tapered Roller Bearings
Inch Series
Bore Diameter: 39.688~42.875mm

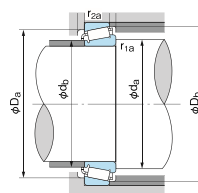
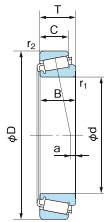

Dynamic equivalent radial load
 $F_r = XFr + YFa$

$\frac{F_a}{F_r} \leq e$		$\frac{F_a}{F_r} > e$	
X	Y	X	Y
1	0	0.4	Y_1

Values e and Y_1 from table.

Static equivalent radial load
Larger value of following to be used:
 $P_0 = 0.5Fr + Y_0Fa$
 $P_0 = Fr$
Values Y_0 from table.

1N=0.102kgf

Boundary dimensions (mm)								Bearing No.		Basic load rating		Limiting speed (min ⁻¹)		Abutment and fillet dimensions (mm)						Load center (mm)	Constant	Axial load factor		Mass(kg) Reference		Bearing No.	
d	D	T	B	C	r ₁ (min)	r ₂ (min)		Cone	Cup	Cr (kN)	Cor (kN)	Grease	Oil	d _s	d _b	D _s	D _b	r _{1a}	r _{2a}	a	e	Y ₁	Y ₀	Cone	Cup	Cone	Cup
39.688	73.025	25.654	22.098	21.336	0.80	2.40		H-M201047R	H-M201011	68.4	90.6	5300	7100	48.0	45.5	64.0	69.0	0.80	2.40	5.8	0.33	1.80	0.99	0.278	0.167	H-M201047R	H-M201011
	76.200	23.813	25.654	19.050	3.60	3.20		H-2789R	H-2720	74.1	92.2	5400	7200	52.0	45.0	66.0	70.0	3.60	3.20	8.1	0.30	1.98	1.09	0.289	0.185	H-2789R	H-2720
	76.200	23.813	25.654	19.050	3.60	0.80		H-2789R	H-2729	74.1	92.2	5400	7200	52.0	45.0	68.0	70.0	3.60	0.80	8.1	0.30	1.98	1.09	0.289	0.189	H-2789R	H-2729
40.000	76.200	20.638	20.940	15.507	1.60	1.20		28158	28300	57.3	65.9	5300	7000	47.5	45.0	68.0	71.0	1.60	1.20	4.5	0.40	1.49	0.82	0.266	0.137	28158	28300
40.987	67.975	17.500	18.000	13.500	SP	1.60		H-LM300849	H-LM300811	44.0	59.5	5500	7400	52.0	45.0	61.0	65.0	SP	1.60	3.6	0.35	1.72	0.95	1.157	0.081	H-LM300849	H-LM300811
41.275	73.025	16.667	17.463	12.700	3.60	1.60		H-18590	H-18520	45.9	55.8	5200	6900	53.0	46.0	66.0	69.0	3.60	1.60	2.2	0.35	1.71	0.94	0.199	0.085	H-18590	H-18520
	73.431	19.558	19.812	14.732	3.60	0.80		H-LM501349	H-LM501310	57.8	73.0	5200	7000	53.0	46.5	67.0	70.0	3.60	0.80	3.5	0.40	1.50	0.83	0.227	0.167	H-LM501349	H-LM501310
	73.431	21.430	19.812	16.604	3.60	0.80		H-LM501349	H-LM501314	57.8	73.0	5200	7000	53.0	46.5	66.0	70.0	3.60	0.80	3.5	0.40	1.50	0.83	0.227	0.126	H-LM501349	H-LM501314
	76.200	18.009	17.384	14.288	1.60	1.60		11162R	11300	51.6	63.3	5200	6900	49.0	46.5	67.0	72.0	1.60	1.60	0.5	0.49	1.23	0.68	0.221	0.127	11162R	11300
	76.200	22.225	23.020	17.463	3.60	0.80		24780R	24720	66.3	83.3	5200	6900	54.0	47.0	68.0	72.0	3.60	0.80	4.8	0.39	1.53	0.84	0.275	0.148	24780R	24720
	76.200	25.400	23.020	20.638	3.60	2.40		24780R	24721	66.3	83.3	5200	6900	54.0	47.0	72.0	66.0	3.60	2.40	4.8	0.39	1.53	0.84	0.275	0.186	24780R	24721
	79.375	23.813	25.400	19.050	3.60	0.80		H-26882R.	H-26822.	81.1	105	5000	6700	54.0	47.0	71.0	74.0	3.60	0.80	7.5	0.32	1.88	1.04	0.355	0.186	H-26882R.	H-26822.
	80.167	25.400	25.400	20.638	3.60	3.20		H-26882R.	H-26820.	81.1	105	5000	6700	54.0	47.0	70.0	74.0	3.60	3.20	7.5	0.32	1.88	1.04	0.355	0.217	H-26882R.	H-26820.
	80.167	29.370	30.391	23.813	3.60	3.20		3383	3320	91	106	5000	6700	53.0	46.5	70.0	75.0	3.60	3.20	10.7	0.27	2.20	1.21	0.419	0.217	3383	3320
	80.167	29.370	30.391	23.813	0.80	3.20		3384	3320	91	106	5000	6700	47.0	46.5	70.0	75.0	0.80	3.20	10.7	0.27	2.20	1.21	0.421	0.217	3384	3320
	82.550	26.543	25.654	20.193	3.60	3.30		H-M802048	H-M802011	83.7	105	4900	6500	57.0	50.6	70.0	79.0	3.60	3.30	3.3	0.55	1.10	0.60	0.403	0.227	H-M802048	H-M802011
	84.138	30.163	30.886	23.813	3.60	3.20		3577R	3520	95.8	120	4600	6200	54.0	48.0	74.0	79.5	3.60	3.20	9.7	0.31	1.96	1.08	0.532	0.221	3577R	3520
	85.725	30.162	30.162	23.812	3.60	3.20		3877R	3820	108	136	4800	6400	57.0	50.3	73.0	81.0	3.60	3.20	8.4	0.40	1.49	0.82	0.525	0.285	3877R	3820
	87.313	30.163	30.886	23.813	3.60	3.20		3577R	3525	95.8	120	4600	6200	54.0	48.0	75.0	81.0	3.60	3.20	9.7	0.31	1.96	1.08	0.532	0.3	3577R	3525
	87.313	30.163	30.886	23.813	1.60	3.20		H-3585R	H-3525	95.8	120	4600	6200	50.0	48.0	75.0	81.0	1.60	3.20	9.7	0.31	1.96	1.08	0.537	0.3	H-3585R	H-3525
	88.900	30.163	29.370	23.020	0.80	3.30		HM803145	HM803110	99.6	125	4600	6100	54.0	53.0	74.0	85.0	0.80	3.30	4.1	0.55	1.10	0.60	0.577	0.318	HM803145	HM803110
	88.900	30.163	29.370	23.020	3.60	3.30		HM803146	HM803110	99.6	125	4600	6100	60.0	53.0	74.0	85.0	3.60	3.30	4.1	0.55	1.10	0.60	0.574	0.318	HM803146	HM803110
	90.488	39.688	40.386	33.338	3.60	3.20		4388	4335	132	169	4500	6000	57.0	51.0	77.0	85.0	3.60	3.20	14.1	0.28	2.11	1.16	0.775	0.454	4388	4335
42.863	87.313	30.163	30.886	23.813	3.60	3.20		H-3579R	H-3525	95.8	120	4600	6200	56.0	49.5	75.0	81.0	3.60	3.20	9.7	0.31	1.96	1.08	0.507	0.3	H-3579R	H-3525
42.875	82.931	26.988	25.400	22.225	3.60	2.40		H-25577	H-25523	77.3	100	4800	6300	55.0	49.0	77.0	72.0	3.60	2.40	6.3	0.33	1.79	0.99	0.383	0.246	H-25577	H-25523
	83.058	23.876	25.400	19.114	3.60	2.00		H-25577	H-25522	77.3	100	4800	6300	55.0	49.0	73.0	77.0	3.60	2.00	6.3	0.33	1.79	0.99	0.383	0.203	H-25577	H-25522

Notes: (*) Minus value of load center "a" indicates that the center is located outside of cone backface.
(*) SP indicates special surface handling configurations.

Tapered Roller Bearings
Inch Series

Bore Diameter: 44.450~45.618mm

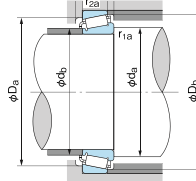
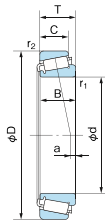

Dynamic equivalent radial load
 $F_r = XFr + YFa$

$\frac{F_a}{F_r} \leq e$		$\frac{F_a}{F_r} > e$	
X	Y	X	Y
1	0	0.4	Y_1

Values e and Y_1 from table.

Static equivalent radial load

Larger value of following to be used:
 $P_{0r} = 0.5Fr + Y_0Fa$
 $P_{0r} = Fr$
Values Y_0 from table.

1N=0.102kgf

Boundary dimensions (mm)								Bearing No.		Basic load rating		Limiting speed (min ⁻¹)		Abutment and fillet dimensions (mm)						Load center (mm)	Constant	Axial load factor		Mass(kg) Reference		Bearing No.	
d	D	T	B	C	r1 (min)	r2 (min)		Cone	Cup	Cr (kN)	Cor (kN)	Grease	Oil	da	db	Da	Db	ra	rs	a	e	Y1	Y0	Cone	Cup	Cone	Cup
44.450	82.931	23.813	25.400	19.050	3.60	0.80		H-25580	H-25520	77.3	100	4800	6300	57.0	55.0	74.0	77.0	3.60	0.80	6.3	0.33	1.79	0.99	0.362	0.2	H-25580	H-25520
	82.931	23.813	25.400	19.050	0.50	0.80		H-25581	H-25520	77.3	100	4800	6300	51.0	50.0	74.0	77.0	0.50	0.80	6.3	0.33	1.79	0.99	0.365	0.2	H-25581	H-25520
	83.058	23.876	25.400	19.114	3.60	2.00		H-25582	H-25522	77.3	100	4800	6300	57.0	50.0	73.0	77.0	3.60	2.00	6.3	0.33	1.79	0.99	0.362	0.203	H-25580	H-25522
	84.138	30.163	30.886	23.813	3.60	3.20		3578R	3520	95.8	120	4600	6200	57.0	51.0	74.0	79.5	3.60	3.20	9.7	0.31	1.96	1.08	0.479	0.221	3578R	3520
	85.001	20.638	21.692	17.463	3.60	1.30		355X	354A	71.8	81.7	4600	6200	56.0	50.0	77.0	80.0	3.60	1.30	5.1	0.31	1.96	1.08	0.342	0.16	355X	354A
	87.313	30.163	30.886	23.813	3.60	3.20		H-3578R	H-3525	95.8	120	4600	6200	57.0	51.0	75.0	81.0	3.60	3.20	9.7	0.31	1.96	1.08	0.483	0.3	H-3578R	H-3525
	88.900	30.163	29.370	23.020	3.60	3.20		HM803149	HM803110	99.6	125	4600	6100	62.0	53.4	74.0	85.0	3.60	3.20	4.1	0.55	1.10	0.60	0.525	0.318	HM803149	HM803110
	90.119	23.000	21.692	21.808	3.60	2.40		355X	352	71.8	81.7	4600	6200	56.0	50.0	82.0	78.0	3.60	2.40	5.1	0.31	1.96	1.08	0.342	0.318	355X	352
	92.075	30.163	29.370	23.020	3.60	3.20		HM803149	HM803112	99.6	125	4600	6100	62.0	53.4	75.0	85.0	3.60	3.20	4.1	0.55	1.10	0.60	0.525	0.398	HM803149	HM803112
	93.264	30.163	30.302	23.813	3.60	3.20		3782	3720	103	137	4200	5500	58.0	52.0	82.0	88.0	3.60	3.20	8.0	0.34	1.77	0.97	0.658	0.288	3782	3720
	95.250	30.958	28.301	20.638	1.20	0.80		53176	53375	88.7	98.4	3700	5200	59.0	52.5	81.0	89.0	1.20	0.80	1.0	0.74	0.81	0.45	0.562	0.363	53176	53375
	95.250	30.958	28.301	20.638	3.60	0.80		53177	53375	88.7	98.4	3700	5200	63.0	52.5	81.0	89.0	3.60	0.80	1.0	0.74	0.81	0.45	0.557	0.363	53177	53375
	95.250	27.783	28.575	22.225	0.80	0.80		33885	33822	108	141	4100	5400	53.0	53.0	86.0	90.0	0.80	0.80	7.4	0.33	1.82	1.00	0.714	0.267	33885	33822
	95.250	30.958	28.575	22.225	3.60	0.80		HM903249	HM903210	99.7	120	3700	5100	65.0	54.0	81.0	91.0	3.60	0.80	0.1	0.74	0.81	0.45	0.613	0.383	HM903249	HM903210
	95.250	30.163	29.370	23.020	3.60	3.20		HM804843	HM804810	104	140	3300	4400	63.0	57.0	81.0	91.0	3.60	3.20	3.7	0.55	1.10	0.60	0.67	0.351	HM804843	HM804810
	104.775	30.163	30.958	23.813	0.80	3.20		45280	45220	126	165	3700	4900	55.0	54.0	93.0	99.0	0.80	3.20	8.0	0.33	1.80	0.99	1	0.345	45280	45220
	104.775	36.513	36.513	28.575	3.60	3.20		HM807040	HM807010	141	195	3800	5100	66.0	59.0	89.0	100.0	3.60	3.20	7.2	0.49	1.23	0.68	1.13	0.497	HM807040	HM807010
	111.125	30.163	26.909	20.638	3.60	3.20		55175CR	55437	111	150	3100	4300	67.0	60.0	92.0	105.0	3.60	3.20	(7.2)	0.88	0.68	0.37	0.938	0.507	55175CR	55437
	114.300	44.450	44.450	34.925	3.60	3.20		65385	65320	189	230	3800	5000	65.0	59.0	97.0	107.0	3.60	3.20	12.5	0.43	1.40	0.77	1.48	0.869	65385	65320
44.983	82.931	23.813	25.400	19.050	1.60	0.80		H-25584	H-25520	77.3	100	4800	6300	53.0	51.0	74.0	77.0	1.60	0.80	6.3	0.33	1.79	0.99	0.357	0.2	H-25584	H-25520
	83.058	23.813	25.400	19.050	1.60	3.20		H-25584	H-25521	77.3	100	4800	6300	53.0	51.0	72.0	77.0	1.60	3.20	6.3	0.33	1.79	0.99	0.357	0.2	H-25584	H-25521
	83.058	23.876	25.400	19.114	1.60	2.00		H-25584	H-25522	77.3	100	4800	6300	53.0	51.0	73.0	77.0	1.60	2.00	6.3	0.33	1.79	0.99	0.357	0.203	H-25584	H-25522
	83.264	30.163	30.302	23.813	3.60	3.20		3776	3720	103	137	4200	5500	59.0	53.0	82.0	88.0	3.60	3.20	8.0	0.34	1.77	0.97	0.650	0.228	3776	3720
45.230	79.985	19.842	20.638	15.080	2.00	1.20		H-17887	H-17831	55.1	70.8	4800	6400	57.0	52.0	68.0	74.0	2.00	1.20	4.0	0.37	1.64	0.90	0.275	0.134	H-17887	H-17831
45.237	84.138	30.163	30.886	23.813	3.60	3.20		3586R	3520	95.8	120	4600	6200	58.0	52.0	74.0	79.5	3.60	3.20	9.7	0.31	1.96	1.08	0.467	0.221	3586R	3520
	87.313	30.163	30.886	23.813	3.60	3.20		3586R	3525	95.8	120	4600	6200	58.0	52.0	75.0	81.0	3.60	3.20	9.7	0.31	1.96	1.08	0.467	0.3	3586R	3525
45.242	73.431	19.558	19.812	15.748	3.60	0.80		H-LM102949	H-LM102910	55.6	78.1	5100	6700	56.0	50.0	68.0	70.0	3.60	0.80	4.9	0.31	1.97	1.08	0.209	0.100	H-LM102949	H-LM102910
	77.788	19.842	19.842	15.080	3.60	0.80		H-LM603049	H-LM603011	57.1	73.5	4900	6500	57.0	50.0	71.0	74.0	3.60	0.80	2.3	0.43	1.41	0.77	0.243	0.120	H-LM603049	H-LM603011
	77.788	21.430	19.842	16.667	3.60	0.80		H-LM603049	H-LM603012	57.1	73.5	4900	6500	57.0	50.0	71.0	74.0	3.60	0.80	2.3	0.43	1.41	0.77	0.243	0.138	H-LM603049	H-LM603012
	79.974	19.842	19.842	15.080	3.60	0.80		H-LM603049	H-LM603014	57.1	73.5	4900	6500	57.0	50.0	71.0	74.0	3.60	0.80	2.3	0.43	1.41	0.77	0.243	0.152	H-LM603049	H-LM603014
45.618	82.931	23.813	25.400	19.050	3.60	0.80		H-25590	H-25520	77.3	100	4800	6300	58.0	51.0	74.0	77.0	3.60	0.80	6.3	0.33	1.79	0.99	0.345	0.201	H-25590	H-25520
	82.931	26.988	25.400	22.225	3.60	2.40		H-25590	H-25523	77.3	100	4800	6300	58.0	51.0	72.0	77.0	3.60	2.40	6.3	0.33	1.79	0.99	0.345	0.246	H-25590	H-25523
	83.058	23.876	25.400	19.114	3.60	2.00		H-25590	H-25522	77.3	100	4800	6300	58.0	51.0	73.0	77.0	3.60	2.00	6.3	0.33	1.79	0.99	0.345	0.203	H-25590	H-25522
	83.058	23.813	25.400	19.050	3.60	3.20		H-25590	H-25521	77.3	100	4800	6300	58.0	51.0	72.0	77.0	3.60	3.20	6.3	0.33	1.79	0.99	0.345	0.2	H-25590	H-25521

Note: (1) Minus value of load center "a" indicates that the center is located outside of cone backface.

Tapered Roller Bearings
Inch Series

Bore Diameter: 46.038~51.592mm

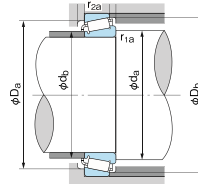
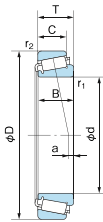

■ Dynamic equivalent radial load
 $F_r = XFr + YFa$

$\frac{F_a}{F_r} \leq e$		$\frac{F_a}{F_r} > e$	
X	Y	X	Y
1	0	0.4	Y_1

Values e and Y_1 from table.

■ Static equivalent radial load
Larger value of following to be used:
 $P_{or} = 0.5Fr + Y_0Fa$
 $P_{or} = Fr$
Values Y_0 from table.

Boundary dimensions (mm)								Bearing No.		Basic load rating		Limiting speed (min ⁻¹)		Abutment and fillet dimensions (mm)						Load center (mm)	Constant e	Axial load factor		Mass(kg) Reference		Bearing No.	
d	D	T	B	C	r ₁ (min)	r ₂ (min)		Cone	Cup	Cr (kN)	Cor (kN)	Grease	Oil	d _s	d _b	D _a	D _b	r _{1a}	r _{2a}	a		Y ₁	Y ₀	Cone	Cup	Cone	Cup
46.038	79.375	17.463	17.463	13.495	2.80	1.60		18690	18620	47.1	59.1	4800	6400	56.0	51.0	71.0	74.0	2.80	1.60	1.5	0.37	1.60	0.88	0.208	0.123	18690	18620
	85.001	20.638	21.692	17.463	2.40	1.30		359S	354A	71.8	81.7	4600	6200	55.0	51.0	77.0	80.0	2.40	1.30	5.1	0.31	1.96	1.08	0.323	0.160	359S	354A
47.625	88.900	20.638	22.225	16.513	2.40	1.30		369S	362A	74.3	87.3	4400	5800	57.0	53.0	81.0	84.0	2.40	1.30	4.6	0.32	1.88	1.03	0.375	0.164	369S	362A
	88.900	25.400	25.400	19.050	3.60	3.20		M804049	M804010	87.1	112	4400	5900	62.0	55.0	76.0	85.0	3.60	3.20	2.1	0.55	1.10	0.60	0.450	0.216	M804049	M804010
	90.000	20.000	22.225	15.875	3.60	2.00		369A	362	74.3	87.3	4400	5800	60.0	53.0	81.0	84.0	3.60	2.00	4.6	0.32	1.88	1.03	0.373	0.173	369A	362
	93.264	30.163	30.302	23.813	3.60	3.20		3779	3720	103	137	4200	5500	61.0	55.0	82.0	88.0	3.60	3.20	8.0	0.34	1.77	0.97	0.606	0.288	3779	3720
	95.250	30.163	29.370	23.020	3.60	3.20		HM804846	HM804810	104	140	3300	4400	64.0	57.0	81.0	91.0	3.60	3.20	3.6	0.55	1.10	0.60	0.617	0.351	HM804846	HM804810
107.950	36.513	36.957	28.575	3.60	3.20		536	532X	138	172	3800	5100	62.0	56.0	94.0	100.0	3.60	3.20	12.3	0.30	2.03	1.11	1.04	0.569	536	532X	
48.412	95.250	30.163	29.370	23.020	2.40	3.20		HM804948	HM804810	104	140	3300	4400	63.0	57.5	81.0	91.0	2.40	3.20	3.7	0.55	1.10	0.60	0.606	0.351	HM804848	HM804810
49.213	104.775	36.513	36.513	28.575	3.60	3.20		HM807044	HM807010	141	195	3800	5100	69.0	63.0	89.0	100.0	3.60	3.20	7.2	0.49	1.23	0.68	1.03	0.497	HM807044	HM807010
50.000	82.000	21.500	21.500	17.000	3.00	0.50		H-JLM104948	H-JLM104910	71.7	97.9	4500	6000	60.0	55.0	76.0	78.0	3.00	0.50	5.3	0.31	1.97	1.08	0.304	0.128	H-JLM104948	H-JLM104910
	84.000	22.000	22.000	17.500	3.50	1.50		H-JLM704649	H-JLM704610	70.2	96.2	4500	6000	62.0	56.0	76.0	80.0	3.50	1.50	2.5	0.44	1.37	0.75	0.324	0.161	H-JLM704649	H-JLM704610
	90.000	28.000	28.000	23.000	3.00	2.50		JM205149	JM205110	105	138	4300	5800	62.0	57.0	80.0	85.0	3.00	2.50	7.8	0.33	1.82	1.00	0.508	0.243	JM205149	JM205110
	105.000	37.000	36.000	29.000	3.00	2.50		JHM807045E	JHM807012E	149	205	3800	5100	69.0	63.0	90.0	100.0	3.00	2.50	7.6	0.49	1.23	0.68	1.01	0.523	JHM807045E	JHM807012E
50.800	82.550	21.590	22.225	16.510	3.60	1.20		H-LM104949	H-LM104911	61.2	84.3	4500	6000	62.0	55.0	75.0	78.0	3.60	1.20	5.2	0.31	1.97	1.08	0.287	0.131	H-LM104949	H-LM104911
	82.931	21.590	22.225	16.510	3.60	1.20		H-LM104949	H-LM104912	61.2	84.3	4500	6000	62.0	55.0	75.0	78.0	3.60	1.20	5.2	0.31	1.97	1.08	0.287	0.138	H-LM104949	H-LM104912
	85.001	17.463	17.463	13.495	3.60	1.60		18790	18720	49.7	65.5	4400	5900	62.0	56.0	77.0	80.0	3.60	1.60	0.1	0.41	1.48	0.81	0.227	0.133	18790	18720
	88.900	20.638	22.225	16.513	3.60	1.30		368A	362A	74.3	87.3	4400	5800	62.0	56.0	81.0	84.0	3.60	1.30	4.6	0.32	1.88	1.03	0.331	0.164	368A	362A
	89.980	24.750	25.400	19.987	3.60	2.40		28580R	28520	84.8	119	4200	5600	63.0	57.0	81.0	86.0	3.60	2.40	4.7	0.38	1.59	0.87	0.458	0.198	28580R	28520
	90.000	20.000	22.225	15.875	3.60	2.00		368A	362	74.3	87.3	4400	5800	62.0	56.0	81.0	84.0	3.60	2.00	4.6	0.32	1.88	1.03	0.331	0.173	368A	362
	92.075	24.608	25.400	19.845	3.60	0.80		28580R	28521	84.8	119	4200	5600	63.0	57.0	83.0	87.0	3.60	0.80	4.7	0.38	1.59	0.87	0.453	0.247	28580R	28521
	93.264	30.163	30.302	23.813	0.80	3.20		3775	3720	103	137	4200	5500	58.0	58.0	82.0	88.0	0.80	3.20	8.0	0.34	1.77	0.97	0.551	0.288	3775	3720
	93.264	30.163	30.302	23.813	3.60	3.20		3780	3720	103	137	4200	5500	64.0	58.0	82.0	88.0	3.60	3.20	8.0	0.34	1.77	0.97	0.547	0.288	3780	3720
	95.250	27.783	28.575	22.225	3.60	2.40		33889	33821	108	141	4100	5400	64.0	58.0	85.0	90.0	3.60	2.40	7.4	0.33	1.82	1.00	0.604	0.264	33889	33821
	95.250	27.783	28.575	22.225	3.60	0.80		33889	33822	108	141	4100	5400	64.0	58.0	86.0	90.0	3.60	0.80	7.4	0.33	1.82	1.00	0.604	0.267	33889	33822
	97.630	24.608	24.608	19.446	3.60	0.80		28678	28622	89.6	131	3900	5200	65.0	58.0	88.0	92.0	3.60	0.80	3.4	0.40	1.49	0.82	0.569	0.267	28678	28622
	101.600	31.750	31.750	25.400	3.60	3.20		49585	49520	114	143	3900	5200	66.0	59.0	88.0	96.0	3.60	3.20	7.8	0.40	1.50	0.82	0.736	0.384	49585	49520
	101.600	34.925	36.068	26.988	0.80	3.20		529	522	131	159	4000	5300	59.0	58.0	89.0	95.0	0.80	3.20	12.7	0.29	2.10	1.16	0.806	0.411	529	522
	101.600	34.925	36.068	26.988	3.60	3.20		529X	522	131	159	4000	5300	65.0	58.0	89.0	95.0	3.60	3.20	12.7	0.29	2.10	1.16	0.802	0.411	529X	522
104.775	30.163	30.958	23.813	6.40	3.20		45284	45220	126	165	3700	4900	71.0	59.0	93.0	99.0	6.40	3.20	8.0	0.33	1.80	0.99	0.873	0.345	45284	45220	
104.775	36.513	36.513	28.575	3.60	3.20		HM807046	HM807010	141	195	3800	5100	70.0	63.0	89.0	100.0	3.60	3.20	7.2	0.49	1.23	0.68	0.995	0.497	HM807046	HM807010	
107.950	36.513	36.957	28.575	3.60	3.20		537	532X	138	172	3800	5100	65.0	59.0	94.0	100.0	3.60	3.20	12.3	0.30	2.03	1.11	0.969	0.569	537	532X	
51.592	90.000	20.000	22.225	15.875	2.00	2.00		368S	362	74.3	87.3	4400	5800	59.0	56.0	81.0	84.0	2.00	2.00	4.6	0.32	1.88	1.03	0.322	0.173	368S	362

Note: (†) Minus value of load center "a" indicates that the center is located outside of cone backface.

Tapered Roller Bearings
Inch Series
Bore Diameter: 52.388~55.563mm

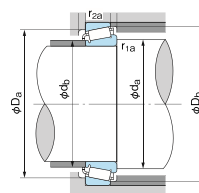
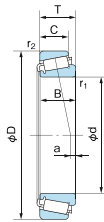

Dynamic equivalent radial load
 $F_r = XFr + YFa$

$\frac{F_a}{F_r} \leq e$		$\frac{F_a}{F_r} > e$	
X	Y	X	Y
1	0	0.4	Y_1

Values e and Y_1 from table.

Static equivalent radial load

Larger value of following to be used:
 $P_0 = 0.5Fr + Y_0Fa$
 $P_0 = Fr$
Values Y_0 from table.

1N=0.102kgf

Boundary dimensions (mm)				Bearing No.		Basic load rating		Limiting speed (min ⁻¹)		Abutment and fillet dimensions (mm)						Load center (mm)	Constant	Axial load factor		Mass(kg) Reference		Bearing No.				
d	D	T	B	C	r ₁ (min)	r ₂ (min)	Cone	Cup	Cr (kN)	Cor (kN)	Grease	Oil	d _a	d _b	D _a	D _b	r _{1a}	r _{2a}	a (°)	e	Y ₁	Y ₀	Cone	Cup	Cone	Cup
52.388	92.075	24.608	25.400	19.845	3.60	0.80	28584R	28521	84.8	119	4200	5600	65.0	58.0	83.0	87.0	3.60	0.80	4.7	0.38	1.59	0.87	0.435	0.247	28584R	28521
	93.264	30.163	30.302	23.813	2.40	3.20	3767	3720	103	137	4200	5500	63.0	59.0	82.0	88.0	2.40	3.20	8.0	0.34	1.77	0.97	0.519	0.288	3767	3720
	95.250	27.783	28.575	22.225	1.60	2.40	33890	33821	108	141	4100	5400	61.0	59.0	85.0	90.0	1.60	2.40	7.4	0.33	1.82	1.00	0.581	0.264	33890	33821
	95.250	27.783	28.575	22.225	3.60	2.40	33891	33821	108	141	4100	5400	66.0	59.0	85.0	90.0	3.60	2.40	7.4	0.33	1.82	1.00	0.578	0.264	33891	33821
53.975	95.250	27.783	28.575	22.225	1.60	2.40	33895	33821	108	141	4100	5400	63.0	60.0	85.0	90.0	1.60	2.40	7.4	0.33	1.82	1.00	0.551	0.264	33895	33821
	95.250	27.783	28.575	22.225	1.60	0.80	33895	33822	108	141	4100	5400	63.0	60.0	86.0	90.0	1.60	0.80	7.4	0.33	1.82	1.00	0.551	0.267	33895	33822
	96.838	21.001	21.946	15.875	1.60	0.80	389AS	382A	80.4	101	3900	5200	62.0	60.0	89.0	92.0	1.60	0.80	3.6	0.35	1.69	0.93	0.479	0.177	389AS	382A
	98.425	21.001	21.946	17.826	0.80	0.80	389A	382	80.4	101	3900	5200	61.0	60.0	89.0	92.0	0.80	0.80	3.6	0.35	1.69	0.93	0.478	0.223	389A	382
54.991	107.950	36.513	36.957	28.575	3.60	3.20	539	532X	138	172	3800	5100	68.0	61.0	94.0	100.0	3.60	3.20	12.3	0.30	2.03	1.11	0.894	0.569	539	532X
	123.825	38.100	36.678	30.163	3.60	3.20	557S	552A	162	223	3200	4200	71.0	65.0	109.0	116.0	3.60	3.20	9.4	0.35	1.73	0.95	1.47	0.756	557S	552A
55.000	135.755	53.975	56.007	44.450	3.60	3.20	6381	6320	266	357	3000	4000	76.0	70.0	117.0	126.0	3.60	3.20	19.2	0.32	1.85	1.02	2.75	1.37	6381	6320
	90.000	23.000	23.000	18.500	1.60	0.50	JLM506849E	JLM506810E	81.4	115	4200	5500	63.0	61.0	82.0	86.0	1.60	0.50	2.9	0.40	1.49	0.82	0.370	0.183	JLM506849E	JLM506810E
	95.000	29.000	29.000	23.500	1.50	2.50	JM207049A	JM207010	110	150	4000	5300	64.0	62.0	85.0	91.0	1.50	2.50	7.7	0.33	1.79	0.99	0.567	0.256	JM207049A	JM207010
55.563	95.000	29.000	29.000	23.500	6.00	2.50	JM207049A	JM207010	110	150	4000	5300	73.0	62.0	85.0	91.0	6.00	2.50	7.7	0.33	1.79	0.99	0.568	0.256	JM207049A	JM207010
	110.000	39.000	39.000	32.000	3.00	2.50	JH307749E	JH307710E	176	224	3600	4900	71.0	64.0	97.0	104.0	3.00	2.50	11.9	0.35	1.73	0.95	1.16	0.56	JH307749E	JH307710E
97.630	24.608	24.608	19.446	3.60	0.80	28680	28622	89.6	131	3900	5200	68.0	62.0	88.0	92.0	3.60	0.80	3.4	0.40	1.49	0.82	0.492	0.267	28680	28622	

Note: (°) Minus value of load center "a" indicates that the center is located outside of cone backface.

Tapered Roller Bearings
Inch Series
Bore Diameter: 57.150~61.913mm

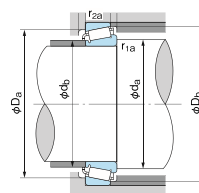
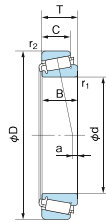

■ Dynamic equivalent radial load
 $F_r = XFr + YFa$

	$\frac{F_a}{F_r} \leq e$	$\frac{F_a}{F_r} > e$
X	Y	X
1	0	0.4
	Y ₁	Y ₁

Values e and Y₁ from table.

■ Static equivalent radial load
Larger value of following to be used:
 $P_{or} = 0.5Fr + Y_0Fa$
 $P_{or} = Fr$
Values Y₀ from table.

1N=0.102kgf

Boundary dimensions (mm)						Bearing No.		Basic load rating		Limiting speed (min ⁻¹)		Abutment and fillet dimensions (mm)						Load center (mm)	Constant	Axial load factor		Mass(kg) Reference		Bearing No.		
d	D	T	B	C	r ₁ (min)	r ₂ (min)	Cone	Cup	Cr (kN)	Cor (kN)	Grease	Oil	d _s	d _b	D _a	D _b	r _{1a}	r _{2a}	a	e	Y ₁	Y ₀	Cone	Cup	Cone	Cup
57.150	96.838	21.001	21.946	15.875	2.40	0.80	387	382A	80.4	101	3900	5200	66.0	62.0	89.0	92.0	2.40	0.80	3.6	0.35	1.69	0.93	0.428	0.177	387	382A
	96.838	25.400	21.946	20.274	2.40	2.40	387	382S	80.4	101	3900	5200	66.0	62.0	87.0	91.0	2.40	2.40	3.6	0.35	1.69	0.93	0.428	0.245	387	382S
	96.838	21.001	21.946	15.875	3.60	0.80	387A	382A	80.4	101	3900	5200	69.0	62.0	89.0	92.0	3.60	0.80	3.6	0.35	1.69	0.93	0.426	0.177	387A	382A
	96.838	25.400	21.946	20.274	3.60	2.40	387A	382S	80.4	101	3900	5200	72.0	62.0	87.0	91.0	3.60	2.40	3.6	0.35	1.69	0.93	0.426	0.245	387A	382S
	96.838	21.001	21.946	15.875	5.00	0.80	387AS	382A	80.4	101	3900	5200	72.0	62.0	89.0	92.0	5.00	0.80	3.6	0.35	1.69	0.93	0.422	0.177	387AS	382A
	96.838	25.400	21.946	20.274	5.00	2.40	387AS	382S	80.4	101	3900	5200	72.0	62.0	87.0	91.0	5.00	2.40	3.6	0.35	1.69	0.93	0.422	0.245	387AS	382S
	96.838	24.608	24.608	19.446	3.60	0.80	28682	28621	89.6	131	3900	5200	70.0	63.0	87.0	91.0	3.60	0.80	3.4	0.40	1.49	0.82	0.466	0.248	28682	28621
	97.630	24.608	24.608	19.446	3.60	0.80	28682	28622	89.6	131	3900	5200	70.0	63.0	88.0	92.0	3.60	0.80	3.4	0.40	1.49	0.82	0.466	0.267	28682	28622
	98.425	21.001	21.946	17.826	2.40	0.80	387	382	80.4	101	3900	5200	66.0	62.0	89.0	92.0	2.40	0.80	3.6	0.35	1.69	0.93	0.428	0.223	387	382
	98.425	21.001	21.946	17.826	3.60	0.80	387A	382	80.4	101	3900	5200	69.0	62.0	89.0	92.0	3.60	0.80	3.6	0.35	1.69	0.93	0.426	0.223	387A	382
	104.775	30.163	29.317	24.605	2.40	3.30	462	453X	109	144	3700	4900	67.0	63.0	92.0	98.0	2.40	3.30	6.6	0.34	1.79	0.98	0.685	0.372	462	453X
	104.775	30.163	29.317	24.605	3.60	3.30	469	453X	109	144	3700	4900	70.0	63.0	92.0	98.0	3.60	3.30	6.6	0.34	1.79	0.98	0.682	0.372	469	453X
	104.775	30.163	30.958	23.813	0.80	3.20	45289	45220	126	165	3700	4900	65.0	65.0	93.0	99.0	0.80	3.20	8.0	0.33	1.80	0.99	0.757	0.345	45289	45220
	104.775	30.163	30.958	23.813	2.40	3.20	45290	45220	126	165	3700	4900	68.0	65.0	93.0	99.0	2.40	3.20	8.0	0.33	1.80	0.99	0.755	0.345	45290	45220
	104.775	30.163	30.958	23.813	2.40	0.80	45290	45221	126	165	3700	4900	68.0	65.0	95.0	99.0	2.40	0.80	8.0	0.33	1.80	0.99	0.755	0.35	45290	45221
	110.000	21.999	21.996	18.824	2.40	1.20	390	394A	86.4	116	3400	4500	70.0	66.0	101.0	104.5	2.40	1.20	0.7	0.40	1.49	0.82	0.682	0.259	390	394A
	112.713	30.163	30.163	23.813	3.60	3.20	39580	39520	147	207	3300	4500	72.0	66.0	101.0	107.0	3.60	3.20	6.9	0.34	1.77	0.97	1.05	0.355	39580	39520
	112.713	30.163	30.163	23.813	7.90	3.20	39581	39520	147	207	3300	4500	81.0	66.0	101.0	107.0	7.90	3.20	6.9	0.34	1.77	0.97	1.03	0.355	39581	39520
	117.475	33.338	31.750	23.813	3.60	3.20	66225R	66462	129	152	3500	4600	76.0	69.0	100.0	111.0	3.60	3.20	0.2	0.63	0.96	0.53	1.03	0.547	66225R	66462
	120.650	41.275	41.275	31.750	3.60	3.20	623	612	174	217	3500	4600	72.0	66.0	105.0	110.0	3.60	3.20	14.0	0.31	1.91	1.05	1.27	0.853	623	612
	123.825	38.100	36.678	30.163	3.60	3.20	555S	552A	162	223	3200	4200	73.0	67.0	109.0	116.0	3.60	3.20	9.4	0.35	1.73	0.95	1.41	0.756	555S	552A
57.531	98.425	21.001	21.946	17.826	3.60	0.80	388A	382	80.4	101	3900	5200	69.0	63.0	89.0	92.0	3.60	0.80	3.6	0.35	1.69	0.93	0.421	0.223	388A	382
59.987	134.983	33.449	30.925	21.948	3.60	3.60	HM911244R	HM911216	153	181	2600	3700	84.0	74.0	112.0	123.0	3.60	3.60	(7.1)	0.82	0.73	0.40	1.37	0.806	HM911244R	HM911216
60.325	100.000	25.400	25.400	19.845	3.60	3.20	2898S	28921	91.4	137	3700	4900	73.0	67.0	89.0	96.0	3.60	3.20	2.6	0.43	1.41	0.78	0.533	0.230	2898S	28921
	100.000	25.400	25.400	19.845	3.60	0.80	2898S	28921A	91.4	137	3700	4900	73.0	67.0	91.0	96.0	3.60	0.80	2.6	0.43	1.41	0.78	0.533	0.235	2898S	28921A
	101.600	25.400	25.400	19.845	3.60	3.20	2898S	28920	91.4	137	3700	4900	73.0	67.0	89.0	96.0	3.60	3.20	2.6	0.43	1.41	0.78	0.533	0.269	2898S	28920
	112.713	30.163	30.048	23.813	3.60	3.20	3980	3920	111	164	3400	4500	75.0	68.0	99.0	106.0	3.60	3.20	4.3	0.40	1.49	0.82	0.853	0.448	3980	3920
	123.825	38.100	36.678	30.163	7.90	3.20	557A	552A	162	223	3200	4200	84.0	69.0	109.0	116.0	7.90	3.20	9.4	0.35	1.73	0.95	1.3	0.756	557A	552A
	127.000	44.450	44.450	34.925	3.60	3.20	65237	65500	208	269	3300	4400	82.0	71.0	107.0	119.0	3.60	3.20	9.3	0.49	1.23	0.68	1.58	1.02	65237	65500
61.913	126.525	46.038	46.038	36.513	3.60	3.20	H715332	H715311	231	369	2800	3700	84.0	78.0	118.0	132.0	3.60	3.20	9.0	0.47	1.27	0.70	2.56	0.950	H715332	H715311
61.913	110.000	21.999	21.996	18.824	0.80	1.20	392	394A	86.4	116	3400	4500	70.0	69.0	101.0	104.5	0.80	1.20	0.7	0.40	1.49	0.82	0.605	0.259	392	394A

Note: (†) Minus value of load center "a" indicates that the center is located outside of cone backface.

Tapered Roller Bearings
Inch Series

Bore Diameter: 63.500~68.263mm

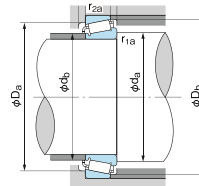
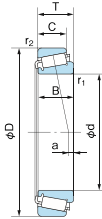

Dynamic equivalent radial load
 $F_r = XFr + YFa$

$\frac{F_a}{F_r} \leq e$		$\frac{F_a}{F_r} > e$	
X	Y	X	Y
1	0	0.4	Y_1

Values e and Y_1 from table.

Static equivalent radial load

Larger value of following to be used:
 $P_{or} = 0.5Fr + Y_0Fa$
 $P_{or} = Fr$
Values Y_0 from table.

1N=0.102kgf

Boundary dimensions (mm)							Bearing No.		Basic load rating		Limiting speed (min ⁻¹)		Abutment and fillet dimensions (mm)						Load center (mm)	Constant e	Axial load factor		Mass(kg) Reference		Bearing No.			
d	D	T	B	C	r ₁ (min)	r ₂ (min)	Cone	Cup	Cr (kN)	Cor (kN)	Grease	Oil	d _s	d _b	D _s	D _b	r _{1a}	r _{2a}	a	Y ₁	Y ₀	Cone	Cup	Cone	Cup	Cone	Cup	
63.500	107.950	25.400	25.400	19.050	3.60	3.20	29585	29520	92.8	143	3400	4500	77.0	71.0	96.0	103.0	3.60	3.20	0.7	0.46	1.31	0.72	0.644	0.277	29585	29520		
	107.950	25.400	25.400	19.050	1.60	0.80	29586	29522	92.8	143	3400	4500	73.0	71.0	98.0	103.0	1.60	0.80	0.7	0.46	1.31	0.72	0.651	0.282	29586	29522		
	110.000	21.999	21.996	18.824	1.60	1.20	390A	394A	86.4	116	3400	4500	73.0	70.0	101.0	104.5	1.60	1.20	0.7	0.40	1.49	0.82	0.579	0.259	390A	394A		
	110.000	21.999	21.996	18.824	3.60	1.20	395	394A	86.4	116	3400	4500	77.0	70.0	101.0	104.5	3.60	1.20	0.7	0.40	1.49	0.82	0.575	0.259	395	394A		
	110.000	25.400	25.400	19.050	3.60	1.20	29585	29521	92.8	143	3400	4500	77.0	71.0	99.0	104.0	3.60	1.20	0.7	0.46	1.31	0.72	0.644	0.333	29585	29521		
	112.713	30.163	30.048	23.813	3.60	3.20	3982	3920	111	164	3400	4500	77.0	71.0	99.0	106.0	3.60	3.20	4.3	0.40	1.49	0.82	0.776	0.448	3982	3920		
	112.713	30.163	30.163	23.813	3.60	3.20	39585	39520	147	207	3300	4500	77.0	71.0	101.0	107.0	3.60	3.20	6.9	0.34	1.77	0.97	0.908	0.355	39585	39520		
	122.238	38.100	38.354	29.718	7.10	3.20	HM212047UR	HM212011UR	191	249	3200	4300	87.0	73.0	108.0	116.0	7.10	3.20	10.8	0.34	1.78	0.98	1.36	0.595	HM212047UR	HM212011UR		
	123.825	38.100	36.678	30.163	3.60	3.20	559	552A	162	223	3200	4200	78.0	72.0	109.0	116.0	3.60	3.20	9.4	0.35	1.73	0.95	1.23	0.756	559	552A		
	136.525	41.275	41.275	31.750	3.60	3.20	639	632	197	267	3000	3900	81.0	74.0	118.0	125.0	3.60	3.20	11.0	0.36	1.66	0.91	1.75	1.03	639	632		
65.000	105.000	24.000	23.000	18.500	3.00	1.00	JLM710949UR	JLM710910UR	95.3	129	3500	4700	77.0	71.0	96.0	100.5	3.00	1.00	0.3	0.45	1.32	0.73	0.513	0.234	JLM710949UR	JLM710910UR		
	110.000	28.000	28.000	22.500	3.00	2.50	JM511946E	JM511910E	136	191	3400	4600	78.0	72.0	99.0	105.0	3.00	2.50	4.0	0.40	1.49	0.82	0.733	0.338	JM511946E	JM511910E		
	120.000	39.000	38.500	32.000	3.00	2.50	JH211749E	JH211710E	189	255	3200	4300	80.0	74.0	107.0	114.0	3.00	2.50	11.1	0.34	1.78	0.98	1.27	0.618	JH211749E	JH211710E		
65.088	135.755	53.975	56.007	44.450	3.60	3.20	6379	6320	266	357	3000	4000	84.0	77.5	117.0	126.0	3.60	3.20	19.2	0.32	1.85	1.02	2.34	1.37	6379	6320		
	107.950	25.400	25.400	19.050	3.60	3.20	29590	29520	92.8	143	3400	4500	80.0	73.0	96.0	103.0	3.60	3.20	0.7	0.46	1.31	0.72	0.582	0.277	29590	29520		
	107.950	25.400	25.400	19.050	3.60	0.80	29590	29522	92.8	143	3400	4500	80.0	73.0	96.0	103.0	3.60	0.80	0.7	0.46	1.31	0.72	0.582	0.282	29590	29522		
	110.000	21.999	21.996	18.824	0.80	1.20	395A	394A	86.4	116	3400	4500	73.0	73.0	101.0	104.5	0.80	1.20	0.7	0.40	1.49	0.82	0.524	0.259	395A	394A		
	110.000	21.999	21.996	18.824	3.60	1.20	395S	394A	86.4	116	3400	4500	79.0	73.0	101.0	104.5	3.60	1.20	0.7	0.40	1.49	0.82	0.519	0.259	395S	394A		
	110.000	25.400	25.400	19.050	3.60	1.20	29590	29521	92.8	143	3400	4500	80.0	73.0	99.0	104.0	3.60	1.20	0.7	0.46	1.31	0.72	0.582	0.333	29590	29521		
	112.713	30.163	30.048	23.813	3.60	3.20	3984	3920	111	164	3400	4500	80.0	74.0	99.0	106.0	3.60	3.20	4.3	0.40	1.49	0.82	0.705	0.448	3984	3920		
	112.713	30.163	30.048	23.813	5.60	3.20	3994	3920	111	164	3400	4500	84.0	74.0	99.0	106.0	5.60	3.20	4.3	0.40	1.49	0.82	0.698	0.448	3994	3920		
	112.713	30.163	30.163	23.813	3.60	3.20	39590	39520	147	207	3300	4500	80.0	74.0	101.0	107.0	3.60	3.20	6.9	0.34	1.77	0.97	0.832	0.355	39590	39520		
	117.475	30.163	30.163	23.813	3.60	3.20	33262	33462	118	179	3200	4200	81.0	75.0	104.0	112.0	3.60	3.20	2.4	0.44	1.38	0.76	0.910	0.436	33262	33462		
66.675	122.238	38.100	38.354	29.718	3.60	1.60	HM212049	HM212010	191	249	3200	4300	82.0	75.5	110.0	116.0	3.60	1.60	10.8	0.34	1.78	0.98	1.26	0.596	HM212049	HM212010		
	122.238	38.100	38.354	29.718	3.60	3.20	HM212049	HM212011	191	249	3200	4300	82.0	75.5	108.0	116.0	3.60	3.20	10.8	0.34	1.78	0.98	1.26	0.591	HM212049	HM212011		
	123.825	38.100	36.678	30.163	3.60	3.20	560	552A	162	223	3200	4200	81.0	75.0	109.0	116.0	3.60	3.20	9.4	0.35	1.73	0.95	1.13	0.756	560	552A		
	136.525	41.275	41.275	31.750	3.60	3.20	641	632	197	267	3000	3900	83.0	77.0	116.0	124.0	3.60	3.20	11.0	0.36	1.66	0.91	1.64	1.03	641	632		
	135.755	53.975	56.007	44.450	4.30	3.20	6386	6320	266	357	3000	4000	87.0	77.5	117.0	126.0	4.30	3.20	19.2	0.32	1.85	1.02	2.27	1.37	6386	6320		
	136.525	46.038	46.038	36.513	3.60	3.20	H715341	H715311	231	369	2800	3700	89.0	83.0	118.0	132.0	3.60	3.20	9.0	0.47	1.27	0.70	2.33	0.95	H715341	H715311		
	110.000	21.999	21.996	18.824	2.40	1.20	399A	394A	86.4	116	3400	4500	78.0	74.0	101.0	104.5	2.40	1.20	0.7	0.40	1.49	0.82	0.493	0.259	399A	394A		
	110.000	21.999	21.996	18.824	5.20	1.20	399AS	394A	86.4	116	3400	4500	83.0	74.0	101.0	104.5	5.20	1.20	0.7	0.40	1.49	0.82	0.485	0.259	399AS	394A		
	120.000	29.794	29.007	24.237	3.60	2.00	480	472	118	161	3200	4200	82.0	75.0	108.0	113.0	3.60	2.00	4.1	0.38	1.56	0.86	0.833	0.487	480	472		
	123.825	38.100	36.678	30.163	3.60	3.20	560S	552A	162	223	3200	4200	83.0	76.0	109.0	116.0	3.60	3.20	9.4	0.35	1.73	0.95	1.09	0.756	560S	552A		
136.525	41.275	41.275	31.750	3.60	3.20	H414245	H414210	241	308	2900	3800	86.0	82.0	121.0	129.0	3.60	3.20	11.0	0.36	1.67	0.92	1.92	0.788	H414245	H414210			

Note: (†) Minus value of load center "a" indicates that the center is located outside of cone backface.

Tapered Roller Bearings
Inch Series

Bore Diameter: 69.850~75,000mm

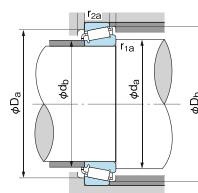
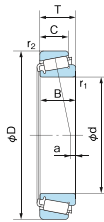

■ **Dynamic equivalent radial load**
 $F_r = XFr + YFa$

$\frac{F_a}{F_r} \leq e$		$\frac{F_a}{F_r} > e$	
X	Y	X	Y
1	0	0.4	Y_1

Values e and Y_1 from table.

■ **Static equivalent radial load**

Larger value of following to be used:
 $P_{0r} = 0.5Fr + Y_0Fa$
 $P_{0r} = Fr$
Values Y_0 from table.

1N=0.102kgf

Boundary dimensions (mm)						Bearing No.		Basic load rating		Limiting speed (min ⁻¹)		Abutment and fillet dimensions (mm)						Load center (mm)	Constant	Axial load factor		Mass(kg) Reference		Bearing No.		
d	D	T	B	C	r ₁ (min)	r ₂ (min)	Cone	Cup	Cr (kN)	Cor (kN)	Grease	Oil	d _s	d _b	D _s	D _b	r _{1a}	r _{2a}	a	e	Y ₁	Y ₀	Cone	Cup	Cone	Cup
69.850	112.713	25.400	25.400	19.050	1.60	3.20	29675	29620	97	155	3200	4300	80.0	77.0	101.0	109.0	1.60	3.20	(0.8)	0.49	1.23	0.68	0.676	0.27	29675	29620
	117.475	30.163	30.163	23.813	3.60	3.20	33275	33462	118	179	3200	4200	84.0	77.0	104.0	112.0	3.60	3.20	2.4	0.44	1.38	0.76	0.830	0.436	33275	33462
	120.000	29.794	29.007	24.237	3.60	2.00	482	472	118	161	3200	4200	83.0	77.0	108.0	113.0	3.60	2.00	4.1	0.38	1.56	0.86	0.791	0.487	482	472
	120.000	29.794	30.163	23.444	3.60	0.80	33275	33472	118	179	3200	4200	84.0	77.0	107.0	113.0	3.60	0.80	2.4	0.44	1.38	0.76	0.832	0.517	33275	33472
	120.000	32.545	32.545	26.195	3.60	3.20	47487R	47420	150	218	3100	4200	84.0	78.0	107.0	114.0	3.60	3.20	6.0	0.36	1.67	0.92	1.01	0.476	47487R	47420
	127.000	36.513	36.170	28.575	3.60	3.20	566	563	156	226	3000	4000	85.0	78.0	112.0	120.0	3.60	3.20	7.9	0.36	1.65	0.91	1.24	0.648	566	563
	136.525	41.275	41.275	31.750	3.60	3.20	643	632	197	267	3000	3900	86.0	80.0	118.0	125.0	3.60	3.20	11.0	0.36	1.66	0.91	1.53	1.03	643	632
146.050	41.275	39.688	25.400	3.60	3.20	H913849R.F	H913810.F	202	237	2300	3300	95.0	82.5	124.0	138.0	3.60	3.20	(4.0)	0.78	0.77	0.42	2.06	0.9	H913849R.F	H913810.F	
70.000	110.000	28.000	25.000	20.500	1.00	2.50	JLM813049	JLM813010	103	158	3300	4400	78.0	77.0	98.0	105.0	1.00	2.50	(0.2)	0.49	1.23	0.68	0.590	0.300	JLM813049	JLM813010
	115.000	29.000	29.000	23.000	3.00	2.50	JM612949	JM612910	123	173	3200	4300	83.0	77.0	103.0	110.0	3.00	2.50	2.8	0.43	1.39	0.77	0.776	0.358	JM612949	JM612910
	120.000	29.794	29.007	24.237	2.00	2.00	484	472	118	161	3200	4200	80.0	77.0	108.0	113.0	2.00	2.00	4.1	0.38	1.56	0.86	0.791	0.487	484	472
71.438	117.475	30.163	30.163	23.813	3.60	3.20	33281	33462	118	179	3200	4200	85.0	79.0	104.0	112.0	3.60	3.20	2.4	0.44	1.38	0.76	0.789	0.436	33281	33462
	120.000	29.794	30.163	23.444	3.60	0.80	33281	33472	118	179	3200	4200	85.0	79.0	107.0	113.0	3.60	0.80	2.4	0.44	1.38	0.76	0.789	0.518	33281	33472
	120.000	32.545	32.545	26.195	3.60	3.20	47490R	47420	150	218	3100	4200	86.0	79.0	107.0	114.0	3.60	3.20	6.0	0.36	1.67	0.92	0.964	0.476	47490R	47420
	136.525	41.275	41.275	31.750	6.40	3.20	645	632	197	267	3000	3900	93.0	81.0	118.0	125.0	6.40	3.20	11.0	0.36	1.66	0.91	1.46	1.03	645	632
	136.525	41.275	41.275	31.750	3.60	3.20	H414249.	H414210.	241	308	2900	3800	89.0	83.3	121.0	129.0	3.60	3.20	11.0	0.36	1.67	0.92	1.80	0.788	H414249.	H414210.
136.525	46.038	46.038	36.513	3.60	3.20	H715345	H715311	231	369	2800	3700	93.0	87.0	118.0	132.0	3.60	3.20	9.0	0.47	1.27	0.70	2.15	0.95	H715345	H715311	
73.025	112.713	25.400	25.400	19.050	3.60	3.20	29685	29620	97	155	3200	4300	86.0	80.0	101.0	109.0	3.60	3.20	(0.8)	0.49	1.23	0.68	0.602	0.27	29685	29620
	117.475	30.163	30.163	23.813	3.60	3.20	33287	33462	118	179	3200	4200	87.0	80.0	104.0	112.0	3.60	3.20	2.4	0.44	1.38	0.76	0.747	0.436	33287	33462
	120.000	29.794	30.163	23.444	3.60	0.80	33287	33472	118	179	3200	4200	87.0	80.0	107.0	113.0	3.60	0.80	2.4	0.44	1.38	0.76	0.747	0.518	33287	33472
	127.000	36.513	36.170	28.575	3.60	3.20	567	563	156	226	3000	4000	88.0	81.0	112.0	120.0	3.60	3.20	7.9	0.36	1.65	0.91	1.14	0.648	567	563
	139.992	36.513	36.098	28.575	3.60	3.20	576R	572	175	262	2700	3600	90.0	83.0	125.0	133.0	3.60	3.20	5.5	0.40	1.49	0.82	1.74	0.779	576R	572
75.000	115.000	25.000	25.000	19.000	3.00	2.50	JLM714149E	JLM714110E	101	151	3100	4200	87.0	81.0	104.0	110.0	3.00	2.50	(0.5)	0.46	1.31	0.72	0.612	0.269	JLM714149E	JLM714110E
	120.000	31.000	29.500	25.000	3.00	2.50	JM714249	JM714210	145	216	3100	4100	88.0	82.9	108.0	115.0	3.00	2.50	3.0	0.44	1.35	0.74	0.846	0.43	JM714249	JM714210
	145.000	51.000	51.000	42.000	3.00	2.50	JH415647	JH415610	290	412	2700	3600	94.0	89.0	129.0	139.0	3.00	2.50	14.4	0.36	1.60	0.91	2.66	1.18	JH415647	JH415610

Note: (*) Minus value of load center "a" indicates that the center is located outside of cone backface.

Tapered Roller Bearings
Inch Series

Bore Diameter: 76.200~84.975mm

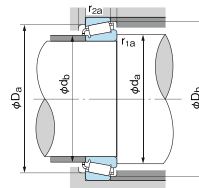
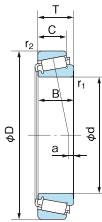

Dynamic equivalent radial load
 $F_r = XFr + YFa$

$\frac{F_a}{F_r} \leq e$		$\frac{F_a}{F_r} > e$	
X	Y	X	Y
1	0	0.4	Y_1

Values e and Y_1 from table.

Static equivalent radial load

Larger value of following to be used:
 $P_0 = 0.5Fr + Y_0Fa$
 $P_0 = Fr$
Values Y_0 from table.

1N=0.102kgf

Boundary dimensions (mm)						Bearing No.		Basic load rating		Limiting speed (min ⁻¹)		Abutment and fillet dimensions (mm)						Load center (mm)	Constant	Axial load factor		Mass(kg) Reference		Bearing No.		
d	D	T	B	C	r ₁ (min)	r ₂ (min)	Cone	Cup	Cr (kN)	Cor (kN)	Grease	Oil	d _s	d _b	D _s	D _b	r _{1a}	r _{2a}	a	e	Y ₁	Y ₀	Cone	Cup	Cone	Cup
76.200	121.442	24.608	23.012	17.463	2.00	2.00	34300	34478	90	127	3000	4000	86.0	83.0	110.0	116.0	2.00	2.00	(2.2)	0.45	1.33	0.73	0.622	0.312	34300	34478
	127.000	26.988	23.012	19.842	2.00	3.20	34300	34500	90	127	3000	4000	86.0	83.0	118.0	112.0	2.00	3.20	(2.2)	0.45	1.33	0.73	0.622	0.536	34300	34500
	127.000	30.163	31.001	22.225	6.40	3.20	42688	42620	143	225	2400	3200	96.0	84.0	114.0	121.0	6.40	3.20	3.1	0.42	1.43	0.79	1.04	0.434	42688	42620
	133.350	33.338	33.338	26.195	6.40	3.20	47678	47620	145	226	2700	3700	97.0	90.0	119.0	128.0	6.40	3.20	4.2	0.40	1.48	0.82	1.31	0.571	47678	47620
	133.350	33.338	33.338	26.195	3.60	3.20	47679	47620	145	226	2700	3700	91.0	85.0	119.0	128.0	3.60	3.20	4.2	0.40	1.48	0.82	1.32	0.571	47679	47620
	135.733	44.450	46.101	34.925	3.60	3.20	5760	5735	213	337	2800	3700	94.0	88.0	119.0	130.0	3.60	3.20	11.5	0.41	1.48	0.81	1.85	0.877	5760	5735
	136.525	30.163	29.769	22.225	3.60	3.20	495A	493	133	198	2700	3600	92.0	86.0	122.0	130.0	3.60	3.20	0.3	0.44	1.35	0.74	1.26	0.544	495A	493
	136.525	30.163	29.769	22.225	6.40	3.20	495AX	493	133	198	2700	3600	98.0	86.0	122.0	130.0	6.40	3.20	0.3	0.44	1.35	0.74	1.25	0.544	495AX	493
	139.992	36.513	36.098	28.575	3.60	3.20	575R	572	175	262	2700	3600	92.0	86.0	125.0	133.0	3.60	3.20	5.5	0.40	1.49	0.82	1.64	0.779	575R	572
	146.050	41.275	41.275	31.750	3.60	3.20	659	653	208	301	2600	3400	93.0	87.0	131.0	139.0	3.60	3.20	7.7	0.41	1.47	0.81	2.16	0.880	659	653
	152.400	41.275	41.275	31.750	3.60	3.20	659	652	208	301	2600	3400	93.0	87.0	134.0	141.0	3.60	3.20	7.7	0.41	1.47	0.81	2.16	1.25	659	652
	161.925	49.213	46.038	31.750	3.60	3.20	9285R	9220	246	286	2100	2900	103.0	90.5	138.0	153.0	3.60	3.20	(1.0)	0.71	0.85	0.47	3.01	1.38	9285R	9220
	161.925	47.625	48.260	38.100	3.60	3.20	755	752	273	391	2400	3200	95.0	88.0	144.0	150.0	3.60	3.20	12.1	0.34	1.76	0.97	3.12	1.59	755	752
	77.788	117.475	25.400	25.400	19.050	3.60	3.20	LM814849	LM814810	101	166	3100	4100	91.0	85.0	105.0	113.0	3.60	3.20	(2.2)	0.51	1.18	0.65	0.619	0.295	LM814849
127.000		30.163	31.001	22.225	3.60	3.20	42690	42620	142	209	2400	3200	91.0	85.0	114.0	121.0	3.60	3.20	3.1	0.42	1.43	0.79	1.00	0.434	42690	42620
79.375	190.500	57.150	57.531	46.038	3.60	3.20	HH221431	HH221410	440	602	2000	2700	103.0	97.0	171.0	179.0	3.60	3.20	14.7	0.33	1.79	0.99	6.16	2.21	HH221431	HH221410
	130.000	35.000	34.000	28.500	3.00	2.50	JM515649	JM515610	168	256	2800	3800	94.0	88.0	117.0	125.0	3.20	2.50	5.4	0.39	1.54	0.85	1.19	0.575	JM515649	JM515610
80.963	136.525	30.163	29.769	22.225	3.60	3.20	496	493	133	198	2700	3600	95.0	89.0	122.0	130.0	3.60	3.20	0.3	0.44	1.35	0.74	1.12	0.544	496	493
	150.089	44.450	46.673	36.513	5.20	3.20	740R	742	264	368	2500	3400	101.0	91.0	134.0	142.0	5.20	3.20	12.0	0.33	1.84	1.01	2.30	1.06	740R	742
	125.413	25.400	25.400	19.845	3.60	1.60	27687	27620	101	162	2900	3800	96.0	89.0	115.0	120.0	3.60	1.60	0.7	0.42	1.44	0.79	0.710	0.344	27687	27620
	133.350	30.163	29.769	22.225	3.60	3.20	495	492A	133	198	2700	3600	97.0	90.0	120.0	128.0	3.60	3.20	0.3	0.44	1.35	0.74	1.08	0.429	495	492A
	133.350	33.338	33.338	26.195	3.60	3.20	47686	47620	145	226	2700	3700	97.0	90.0	119.0	128.0	3.60	3.20	4.2	0.40	1.48	0.82	1.12	0.571	47686	47620
	133.350	33.338	33.338	26.195	6.70	3.20	47687	47620	145	226	2700	3700	103.0	90.0	119.0	128.0	6.70	3.20	4.2	0.40	1.48	0.82	1.1	0.571	47687	47620
82.550	133.350	39.688	39.688	32.545	3.60	3.20	HM516449	HM516410	177	306	2800	3700	99.0	92.0	118.0	128.0	3.60	3.20	7.5	0.40	1.49	0.82	1.34	0.762	HM516449	HM516410
	136.525	30.163	29.769	22.225	3.60	3.20	495	493	133	198	2700	3600	97.0	90.0	122.0	130.0	3.60	3.20	0.3	0.44	1.35	0.74	1.08	0.544	495	493
	139.992	36.513	36.098	28.575	3.60	3.20	580R	572	175	262	2700	3600	98.0	91.0	125.0	133.0	3.60	3.20	5.5	0.40	1.49	0.82	1.41	0.779	580R	572
	146.050	41.275	41.275	31.750	3.60	3.30	663	653	208	301	2600	3400	99.0	92.0	131.0	139.0	3.60	3.30	7.7	0.41	1.47	0.81	1.91	0.880	663	653
	150.089	44.450	46.673	36.513	3.60	3.20	749AR	742	264	368	2500	3400	99.0	93.0	134.0	142.0	3.60	3.20	12.0	0.33	1.84	1.01	2.23	1.06	749AR	742
	152.400	41.275	41.275	31.750	3.60	3.20	663	652	208	301	2600	3400	99.0	92.0	134.0	141.0	3.60	3.20	7.7	0.41	1.47	0.81	1.91	1.25	663	652
83.345	125.413	25.400	25.400	19.845	3.60	1.60	27690	27620	101	162	2900	3800	96.0	90.0	115.0	120.0	3.60	1.60	0.7	0.42	1.44	0.79	0.689	0.344	27690	27620
	136.525	30.163	29.769	22.225	3.60	3.20	498	493	133	198	2700	3600	98.0	91.0	122.0	130.0	3.60	3.20	0.3	0.44	1.35	0.74	1.03	0.544	498	493
84.138	152.400	41.275	41.275	31.750	3.60	3.20	664	652	208	301	2600	3400	99.0	93.0	134.0	141.0	3.60	3.20	7.7	0.41	1.47	0.81	1.84	1.25	664	652
	171.450	49.213	46.038	31.750	3.60	3.20	9385	9321	250	299	1900	2700	111.0	98.0	147.0	164.0	3.60	3.20	(5.9)	0.76	0.79	0.43	3.2	1.49	9385	9321
84.975	125.413	25.400	25.400	19.845	5.00	1.60	27695	27620	101	162	2900	3800	100.0	91.0	115.0	120.0	5.00	1.60	0.7	0.42	1.44	0.79	0.644	0.344	27695	27620

Note: (†) Minus value of load center "a" indicates that the center is located outside of cone backface.

Tapered Roller Bearings
Inch Series
Bore Diameter: 85.000~95.000mm

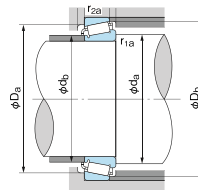
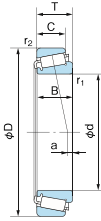

Dynamic equivalent radial load
 $F_r = XFr + YFa$

$\frac{F_a}{F_r} \leq e$		$\frac{F_a}{F_r} > e$	
X	Y	X	Y
1	0	0.4	Y_1

Values e and Y_1 from table.

Static equivalent radial load

Larger value of following to be used:
 $P_0 = 0.5Fr + Y_0Fa$
 $P_0 = Fr$
Values Y_0 from table.

Boundary dimensions (mm)							Bearing No.		Basic load rating		Limiting speed (min ⁻¹)		Abutment and fillet dimensions (mm)						Load center (mm)	Constant e	Axial load factor		Mass(kg) Reference		Bearing No.		
d	D	T	B	C	r ₁ (min)	r ₂ (min)	Cone	Cup	Cr (kN)	Cor (kN)	Grease	Oil	d _a	d _b	D _a	D _b	r _{1a}	r _{2a}	a (°)	Y ₁	Y ₀	Cone	Cup	Cone	Cup	Cone	Cup
85.000	130.000	30.000	29.000	24.000	6.00	2.50	JM716648	JM716610	142	228	2800	3700	104.0	92.0	117.0	125.0	6.00	2.50	0.9	0.44	1.35	0.74	0.933	0.456	JM716648	JM716610	
	130.000	30.000	29.000	24.000	3.00	2.50	JM716649	JM716610	142	228	2800	3700	98.0	92.0	117.0	125.0	3.00	2.50	0.9	0.44	1.35	0.74	0.937	0.456	JM716649	JM716610	
	140.000	39.000	38.000	31.500	3.00	2.50	JHM516849	JHM516810	203	308	2700	3500	100.0	93.9	125.0	134.0	3.00	2.50	6.2	0.41	1.47	0.81	1.54	0.759	JHM516849	JHM516810	
85.001	188.913	53.297	52.761	31.750	3.60	3.20	90334	90744	264	336	1700	2400	116.0	112.0	161.0	179.0	3.60	3.20	(10.0)	0.87	0.69	0.98	4.63	1.87	90334	90744	
	133.350	30.163	29.769	22.225	3.60	3.20	497	492A	133	198	2700	3600	99.0	93.0	120.0	128.0	3.60	3.20	0.3	0.44	1.35	0.74	0.978	0.544	497	492A	
85.725	136.525	30.163	29.769	22.225	3.60	3.20	497	493	133	198	2700	3600	99.0	93.0	122.0	130.0	3.60	3.20	0.3	0.44	1.35	0.74	0.978	0.544	497	493	
	142.138	42.863	42.863	34.133	4.80	3.20	HM617049	HM617010	219	351	2600	3500	106.0	95.7	125.0	137.0	4.80	3.20	7.7	0.43	1.39	0.76	1.72	0.902	HM617049	HM617010	
	146.050	41.275	41.275	31.750	3.60	3.30	665	653	208	301	2600	3400	102.0	95.0	131.0	139.0	3.60	3.30	7.7	0.41	1.47	0.81	1.77	0.880	665	653	
	146.050	41.275	41.275	31.750	6.40	3.30	665A	653	208	301	2600	3400	107.0	95.0	131.0	139.0	6.40	3.30	7.7	0.41	1.47	0.81	1.76	0.880	665A	653	
	152.400	39.688	36.322	30.163	3.60	3.20	596	592A	183	287	2400	3300	102.0	96.0	135.0	144.0	3.60	3.20	2.6	0.44	1.36	0.75	1.83	1.04	596	592A	
	161.925	47.625	48.260	38.100	3.60	3.20	758	752	273	391	2400	3200	103.0	97.0	144.0	150.0	3.60	3.20	12.1	0.34	1.76	0.97	2.67	1.59	758	752	
	152.400	39.688	36.322	33.338	3.60	3.20	593	592	183	287	2400	3300	104.0	98.0	135.0	145.0	3.60	3.20	2.6	0.44	1.36	0.75	1.71	1.1	593	592	
	152.400	39.688	36.322	30.163	6.40	3.20	593A	592A	183	287	2400	3300	110.0	98.0	135.0	144.0	6.40	3.20	2.6	0.44	1.36	0.75	1.7	1.04	593A	592A	
	152.400	39.688	36.322	30.163	3.60	3.20	593	592A	183	287	2400	3300	104.0	98.0	135.0	144.0	3.60	3.20	2.6	0.44	1.36	0.75	1.71	1.04	593	592A	
88.900	152.400	39.688	39.688	30.163	6.40	3.20	HM518445	HM518410	248	359	2400	3200	110.0	98.0	135.0	144.0	6.40	3.20	6.6	0.40	1.49	0.82	2.10	0.768	HM518445	HM518410	
	161.925	47.625	48.260	38.100	3.60	3.20	759	752	273	391	2400	3200	106.0	99.0	144.0	150.0	3.60	3.20	12.1	0.34	1.76	0.97	2.50	1.59	759	752	
	161.925	53.975	55.100	42.863	3.60	3.20	6580R	6535	316	471	2400	3200	109.0	98.0	141.0	154.0	3.60	3.20	12.5	0.40	1.50	0.82	3.09	1.65	6580R	6535	
	161.925	53.975	55.100	42.863	3.60	3.20	850R	832	344	467	2300	3100	106.0	100.0	149.0	155.0	3.60	3.20	19.0	0.30	2.00	1.10	3.29	1.72	850R	832	
	146.975	40.000	40.000	32.499	7.10	3.60	HM218248	HM218210	206	310	2500	3300	112.0	99.0	133.0	141.0	7.10	3.60	9.2	0.33	1.80	0.99	1.66	0.784	HM218248	HM218210	
90.000	145.000	35.000	34.000	27.000	3.00	2.50	JM718149UR	JM718110UR	194	291	2500	3400	105.0	99.0	131.0	139.0	3.00	2.50	2.3	0.44	1.35	0.74	1.47	0.652	JM718149UR	JM718110UR	
	145.000	35.000	34.000	27.000	6.00	2.50	JM718149AUR	JM718110AUR	194	291	2500	3400	111.0	99.0	131.0	139.0	6.00	2.50	2.3	0.44	1.35	0.74	1.46	0.652	JM718149AUR	JM718110AUR	
	155.000	44.000	44.000	35.500	3.00	2.50	JHM318448UR	JHM318410UR	290	407	2400	3200	106.0	100.0	140.0	148.0	3.00	2.50	10.4	0.34	1.76	0.97	2.37	1.00	JHM318448UR	JHM318410UR	
	161.925	53.975	55.100	42.863	3.00	3.20	6581XR	6535	316	471	2400	3200	102.0	98.0	141.0	154.0	3.00	3.20	12.9	0.40	1.50	0.82	3.02	1.65	6581XR	6535	
90.488	161.925	47.625	48.260	38.100	3.60	3.20	760	752	273	391	2400	3200	107.0	101.0	144.0	150.0	3.60	3.20	12.1	0.34	1.76	0.97	2.42	1.59	760	752	
	146.050	33.338	34.925	26.195	3.60	3.20	47890R	47820	178	293	2500	3300	107.0	101.0	131.0	140.0	3.60	3.20	1.2	0.45	1.34	0.74	1.46	0.657	47890R	47820	
	150.000	35.992	36.322	27.000	3.60	3.00	598	593X	183	287	2400	3300	107.0	101.0	134.0	142.0	3.60	3.00	2.6	0.44	1.36	0.75	1.58	0.763	598	593X	
	150.000	35.992	36.322	27.000	6.40	3.00	598A	593X	183	287	2400	3300	113.0	101.0	134.0	142.0	6.40	3.00	2.6	0.44	1.36	0.75	1.57	0.763	598A	593X	
	152.400	39.688	36.322	33.338	3.60	3.20	598	592	183	287	2400	3300	107.0	101.0	135.0	145.0	3.60	3.20	2.6	0.44	1.36	0.75	1.58	1.1	598	592	
	152.400	39.688	36.322	30.163	3.60	3.20	598	592A	183	287	2400	3300	107.0	101.0	135.0	144.0	3.60	3.20	2.6	0.44	1.36	0.75	1.58	1.04	598	592A	
92.075	152.400	39.688	36.322	30.163	6.40	3.20	598A	592A	183	287	2400	3300	113.0	101.0	135.0	144.0	6.40	3.20	2.6	0.44	1.36	0.75	1.57	1.04	598A	592A	
	152.400	39.688	36.322	30.163	6.40	3.20	598AUR	592AUR	183	287	2400	3300	113.0	101.0	135.0	144.0	6.40	3.20	2.6	0.44	1.36	0.75	1.57	1.04	598AUR	592AUR	
	168.275	41.275	41.275	30.163	3.60	3.30	681	672	224	349	2200	3000	110.0	104.0	149.0	160.0	3.60	3.30	2.6	0.47	1.28	0.70	2.61	1.22	681	672	
	148.430	28.575	28.971	21.433	3.00	3.00	42368	42584	143	225	2400	3200	107.0	102.0	134.0	142.0	3.00	3.00	(3.3)	0.49	1.22	0.67	1.21	0.546	42368	42584	
95.000	150.000	35.000	34.000	27.000	3.00	2.50	JM719149	JM719113	187	294	2400	3300	109.0	104.0	135.0	143.0	3.00	2.50	1.5	0.44	1.36	0.75	1.43	0.766	JM719149	JM719113	

Note: (°) Minus value of load center "a" indicates that the center is located outside of cone backface.

Tapered Roller Bearings
Inch Series

Bore Diameter: 95.250~120.650mm

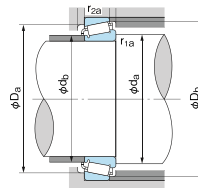
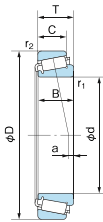

■ **Dynamic equivalent radial load**
 $F_r = XFr + YFa$

$\frac{F_a}{F_r} \leq e$		$\frac{F_a}{F_r} > e$	
X	Y	X	Y
1	0	0.4	Y_1

Values e and Y_1 from table.

■ **Static equivalent radial load**
Larger value of following to be used:
 $P_{or} = 0.5Fr + Y_0Fa$
 $P_{or} = Fr$
Values Y_0 from table.

1N=0.102kgf

Boundary dimensions (mm)							Bearing No.		Basic load rating		Limiting speed (min ⁻¹)		Abutment and fillet dimensions (mm)						Load center (mm)	Constant	Axial load factor		Mass(kg) Reference		Bearing No.	
d	D	T	B	C	r ₁ (min)	r ₂ (min)	Cone	Cup	Cr (kN)	Cor (kN)	Grease	Oil	d _s	d _b	D _a	D _b	r _{1a}	r _{2a}	a (°)	e	Y ₁	Y ₀	Cone	Cup	Cone	Cup
95.250	146.050	33.338	34.925	26.195	3.60	3.20	47896R	47820	178	293	2500	3300	110.0	103.0	131.0	140.0	3.60	3.20	1.2	0.45	1.34	0.74	1.34	0.657	47896R	47820
	149.225	31.750	28.971	24.608	3.60	3.20	42376	42587	143	225	2400	3200	109.0	103.0	98.0	104.0	3.60	3.20	(3.3)	0.49	1.22	0.67	1.15	0.702	42376	42587
	150.000	35.992	36.322	27.000	3.60	3.00	594	593X	183	287	2400	3300	110.0	104.0	134.0	142.0	3.60	3.00	2.6	0.44	1.36	0.75	1.45	0.763	594	593X
	152.400	39.688	36.322	33.338	3.60	3.20	594	592	183	287	2400	3300	110.0	104.0	135.0	145.0	3.60	3.20	2.6	0.44	1.36	0.75	1.45	1.1	594	592
	152.400	39.688	36.322	30.163	3.60	3.20	594A	592A	183	287	2400	3300	110.0	104.0	135.0	144.0	3.60	3.20	2.6	0.44	1.36	0.75	1.45	1.04	594A	592A
	152.400	39.688	36.322	30.163	3.60	3.20	594	592A	183	287	2400	3300	110.0	104.0	135.0	144.0	3.60	3.20	2.6	0.44	1.36	0.75	1.45	1.04	594	592A
168.275	41.275	41.275	30.163	3.60	3.30	683	672	224	349	2200	3000	113.0	106.0	149.0	160.0	3.60	3.30	2.6	0.47	1.28	0.70	2.46	1.22	683	672	
96.838	148.430	28.575	28.971	21.433	3.60	3.00	42381	42584	143	225	2400	3200	110.0	104.0	134.0	142.0	3.60	3.00	(3.3)	0.49	1.22	0.67	1.1	0.546	42381	42584
99.975	156.975	42.000	42.000	34.000	7.90	3.60	HM220149	HM220110	245	396	2300	3100	122.9	109.0	142.0	151.0	7.90	3.60	9.6	0.33	1.80	0.99	2.04	0.862	HM220149	HM220110
100.000	155.000	36.000	35.000	28.000	3.00	2.50	JM720249E	JM720210E	204	328	2300	3100	115.0	109.0	140.0	149.0	3.00	2.50	0.3	0.47	1.27	0.70	1.64	0.763	JM720249E	JM720210E
	160.000	41.000	40.000	32.000	3.00	2.50	JHM720249	JHM720210	237	378	2300	3000	117.0	109.0	143.0	154.0	3.00	2.50	2.7	0.47	1.28	0.70	2.11	0.964	JHM720249	JHM720210
	200.000	52.761	49.213	34.925	3.60	3.20	98394X	98788	347	471	1400	1900	130.0	122.0	174.0	188.0	3.60	3.20	(1.9)	0.63	0.95	0.52	4.65	2.28	98394X	98788
100.013	157.163	36.513	36.116	26.195	3.60	3.20	52393	52618	180	288	2300	3000	116.0	109.0	142.0	152.0	3.60	3.20	0.5	0.47	1.26	0.69	1.74	0.694	52393	52618
101.600	157.163	36.513	36.116	26.195	3.60	3.20	52400	52618	180	288	2300	3000	117.0	111.0	142.0	152.0	3.60	3.20	0.5	0.47	1.26	0.69	1.67	0.694	52400	52618
	180.975	47.625	48.006	38.100	3.60	3.20	780	772	288	438	2100	2800	119.0	113.0	161.0	168.0	3.60	3.20	8.2	0.39	1.56	0.86	3.09	1.92	780	772
	190.500	57.150	57.531	46.038	7.90	3.20	HH221449	HH221410	440	602	2000	2700	131.0	115.0	171.0	179.0	7.90	3.20	14.7	0.33	1.79	0.99	4.72	2.21	HH221449	HH221410
	212.725	66.675	66.675	53.975	7.10	3.20	HH224335	HH224310	513	699	1800	2400	132.0	121.0	192.0	202.0	7.10	3.20	19.9	0.33	1.84	1.01	7.76	3.03	HH224335	HH224310
104.775	180.975	47.625	48.006	38.100	3.60	3.20	782	772	288	438	2100	2800	122.0	116.0	161.0	168.0	3.60	3.20	8.2	0.39	1.56	0.86	2.90	1.92	782	772
	180.975	47.625	48.006	38.100	6.40	3.20	786	772	288	438	2100	2800	128.0	116.0	161.0	168.0	6.40	3.20	8.2	0.39	1.56	0.86	2.88	1.92	786	772
	190.500	47.625	49.213	34.925	3.60	3.20	71412	71750	303	483	1900	2600	124.0	118.0	171.0	181.0	3.60	3.20	6.7	0.42	1.44	0.79	3.96	1.72	71412	71750
107.950	158.750	23.020	21.438	15.875	3.60	3.20	37425	37625	104	169	2200	3000	122.0	115.0	143.0	152.0	3.60	3.20	(13.5)	0.61	0.99	0.54	0.893	0.484	37425	37625
	165.100	36.513	36.513	26.988	3.60	3.20	56425R	56650	195	325	2200	2900	123.0	117.0	149.0	159.0	3.60	3.20	(2.0)	0.50	1.21	0.66	1.76	0.852	56425R	56650
	168.275	36.513	36.513	26.988	3.60	3.20	56425R	56662	195	325	2200	2900	123.0	117.0	150.0	160.0	3.60	3.20	(2.0)	0.50	1.21	0.66	1.76	1.03	56425R	56662
110.000	165.000	35.000	35.000	26.500	3.00	2.50	JM822049	JM822010	195	325	2200	2900	124.0	119.0	149.0	159.0	3.00	2.50	(3.1)	0.50	1.21	0.66	1.64	0.826	JM822049	JM822010
	180.000	47.000	46.000	38.000	3.00	2.50	JHM522649	JHM522610	306	487	2000	2700	127.0	122.0	162.0	172.0	3.00	2.50	6.4	0.41	1.48	0.81	3.08	1.49	JHM522649	JHM522610
	190.500	47.625	49.213	34.925	3.60	3.20	71450	71750	303	483	1900	2600	132.0	125.0	171.0	181.0	3.60	3.20	6.7	0.42	1.44	0.79	3.33	1.72	71450	71750
114.300	212.725	66.675	66.675	53.975	7.10	3.20	HH224346	HH224310	513	699	1800	2400	143.0	131.0	192.0	202.0	7.10	3.20	19.9	0.33	1.84	1.01	6.64	3.03	HH224346	HH224310
	212.725	66.675	66.675	53.975	7.10	3.20	938	932	450	674	1800	2400	141.0	128.0	187.0	193.0	7.10	3.20	19.1	0.33	1.84	1.01	5.96	4.07	938	932
	228.600	53.975	49.428	38.100	3.60	3.20	HM926740	HM926710	430	651	1300	1900	146.0	142.0	200.0	219.0	3.60	3.20	(14.1)	0.74	0.81	0.45	7.25	2.78	HM926740	HM926710
114.975	212.725	66.675	66.675	53.975	7.10	3.20	HH224349	HH224310	513	699	1800	2400	143.0	131.0	192.0	202.0	7.10	3.20	19.9	0.33	1.84	1.01	6.58	3.03	HH224349	HH224310
115.087	190.500	47.625	49.213	34.925	7.90	3.20	71455	71750	303	483	1900	2600	141.0	126.0	171.0	181.0	7.90	3.20	6.7	0.42	1.44	0.79	3.25	1.72	71455	71750
117.475	180.975	34.925	31.750	25.400	3.60	3.20	68462	68712	171	247	2000	2700	132.0	125.0	163.0	172.0	3.60	3.20	(5.8)	0.50	1.21	0.66	1.75	1.04	68462	68712
120.650	206.375	47.625	47.625	34.925	3.20	3.20	795	792	326	548	1700	2300	139.0	134.0	186.0	198.0	3.20	3.20	1.9	0.46	1.31	0.72	4.53	1.88	795	792
	234.950	63.500	63.500	49.213	6.40	3.20	95475	95925	523	826	1600	2100	149.0	137.0	209.0	217.0	6.40	3.20	13.6	0.37	1.62	0.89	8.34	4	95475	95925

Note: (°) Minus value of load center "a" indicates that the center is located outside of cone backface.

Tapered Roller Bearings
Inch Series

Bore Diameter: 123.825~196.850mm

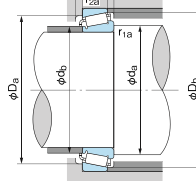
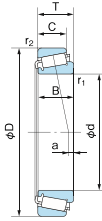

■ **Dynamic equivalent radial load**
 $F_r = XFr + YFa$

X	Y	$\frac{F_a}{F_r} \leq e$		$\frac{F_a}{F_r} > e$	
		1	0	0.4	Y ₁
1	0	0.4	Y ₁		

Values e and Y₁ from table.

■ **Static equivalent radial load**
Larger value of following to be used:
 $P_{0r} = 0.5Fr + Y_0Fa$
 $P_{0r} = Fr$
Values Y₀ from table.

1N=0.102kgf

Boundary dimensions (mm)							Bearing No.		Basic load rating		Limiting speed (min ⁻¹)		Abutment and fillet dimensions (mm)						Load center (mm)	Constant	Axial load factor		Mass(kg) Reference		Bearing No.			
d	D	T	B	C	r ₁ (min)	r ₂ (min)	Cone	Cup	Cr (kN)	Cor (kN)	Grease	Oil	d _s	d _b	D _s	D _b	r _{1a}	r _{2a}	a	e	Y ₁	Y ₀	Cone	Cup	Cone	Cup	Cone	Cup
123.825	182.563	39.688	38.100	33.338	3.60	3.20	48286	48220	227	429	1900	2500	139.0	133.0	168.0	176.0	3.60	3.20	5.6	0.31	1.97	1.08	2.3	1.13	48286	48220		
125.298	228.600	53.975	49.428	38.100	3.60	3.20	HM926745	HM926710	430	651	1300	1900	154.0	143.0	200.0	219.0	3.60	3.20	(14.1)	0.74	0.81	0.45	6.46	2.78	HM926745	HM926710		
127.000	182.563	39.688	38.100	33.338	3.60	3.20	48290	48220	227	429	1700	2300	141.0	135.0	168.0	176.0	3.60	3.20	5.6	0.31	1.97	1.08	2.11	1.13	48290	48220		
	196.850	46.038	46.038	38.100	3.60	3.20	67388	67322	311	561	1700	2300	144.0	138.0	180.0	189.0	3.60	3.20	6.3	0.34	1.74	0.96	3.63	1.45	67388	67322		
	215.900	47.625	47.625	34.925	3.60	3.20	74500	74850	322	549	1600	2200	148.0	141.0	196.0	208.0	3.60	3.20	(2.1)	0.49	1.23	0.68	4.92	1.93	74500	74850		
	228.600	53.975	49.428	38.100	3.60	3.20	HM926747	HM926710	430	651	1300	1900	156.0	143.0	200.0	219.0	3.60	3.20	(14.1)	0.74	0.81	0.45	6.32	2.78	HM926747	HM926710		
254.000	77.788	82.550	61.913	9.50	6.40	HH228349	HH228310	717	1050	1500	2000	164.0	148.0	223.0	234.0	9.50	6.40	23.8	0.32	1.87	1.03	11.8	6.00	HH228349	HH228310			
128.588	206.375	47.625	47.625	34.925	3.20	3.20	799	792	326	548	1700	2300	146.0	140.0	186.0	198.0	3.20	3.20	1.9	0.46	1.31	0.72	3.96	1.88	799	792		
133.350	196.850	46.038	46.038	38.100	3.60	3.20	67390	67322	311	561	1700	2300	149.0	143.0	180.0	189.0	3.60	3.20	6.3	0.34	1.74	0.96	3.17	1.45	67390	67322		
136.525	215.900	47.625	47.625	34.925	3.60	3.20	74525	74850	322	549	1600	2200	152.0	146.0	196.0	208.0	3.60	3.20	(2.1)	0.49	1.23	0.68	4.44	1.93	74525	74850		
139.700	190.500	39.688	39.688	33.338	3.60	3.20	48393	48320	236	472	1800	2400	151.0	144.0	177.0	184.0	3.60	3.20	3.8	0.32	1.87	1.03	2.25	1.15	48393	48320		
	228.600	57.150	57.150	44.450	3.60	3.20	898	892	439	730	1600	2100	160.0	153.0	205.0	216.0	3.60	3.20	6.6	0.42	1.43	0.78	5.6	3.1	898	892		
	236.538	57.150	56.642	44.450	3.60	3.20	HM231132	HM231110	499	832	1500	2000	157.0	153.0	217.0	224.0	3.60	3.20	12.0	0.32	1.88	1.04	7.25	2.8	HM231132	HM231110		
142.875	254.000	66.675	66.675	47.625	7.10	3.20	99550	99100	549	913	1400	1900	170.0	156.0	227.0	238.0	7.10	3.20	11.7	0.41	1.47	0.81	10	4.19	99550	99100		
	193.675	28.575	28.575	23.020	1.60	1.60	36686	36620	187	375	1700	2300	153.0	151.0	182.0	188.0	1.60	1.60	(5.1)	0.37	1.63	0.90	1.71	0.715	36686	36620		
146.050	200.025	41.275	39.688	34.130	3.60	3.30	48685	48620	246	491	1700	2200	158.0	151.0	185.0	193.0	3.60	3.20	2.7	0.34	1.78	0.98	2.46	1.38	48685	48620		
	193.675	28.575	28.575	23.020	1.60	1.60	36690	36620	187	375	1700	2300	155.0	153.0	182.0	188.0	1.60	1.60	(5.1)	0.37	1.63	0.90	1.55	0.715	36690	36620		
149.225	236.538	57.150	56.642	44.450	3.60	3.20	HM231148	HM231110	499	832	1500	2000	164.0	160.0	217.0	224.0	3.60	3.20	12.0	0.32	1.88	1.04	6.52	2.8	HM231148	HM231110		
158.750	225.425	41.275	39.688	33.338	3.60	3.20	46780R	46720	258	568	1400	1900	172.0	163.0	217.0	224.0	6.40	3.20	12.0	0.32	1.88	1.04	6.3	2.8	HM231148	HM231110		
165.100	247.650	47.625	47.625	38.100	3.60	3.20	67780	67720	346	701	1300	1800	176.0	169.0	209.0	218.0	3.60	3.20	(2.7)	0.38	1.57	0.86	3.52	1.64	46780R	46720		
168.275	247.650	47.625	47.625	38.100	3.60	3.20	67782	67720	346	701	1300	1800	185.0	179.0	229.0	240.0	3.60	3.20	(4.7)	0.44	1.36	0.75	5.66	2.3	67780	67720		
170.000	230.000	39.000	38.000	31.000	3.00	2.50	JHM534149	JHM534110	291	558	1400	1900	187.0	181.0	229.0	240.0	3.60	3.20	(4.7)	0.44	1.36	0.75	5.35	2.3	67782	67720		
	240.000	46.000	44.500	37.000	3.00	2.50	JM734449	JM734410	353	666	1400	1800	184.0	178.0	217.0	224.0	3.00	2.50	(4.6)	0.38	1.57	0.86	3.17	1.29	JHM534149	JHM534110		
177.800	247.650	47.625	47.625	38.100	3.60	3.20	67790	67720	346	701	1300	1800	185.0	180.0	222.0	232.0	3.00	2.50	(4.1)	0.44	1.37	0.75	4.31	2.00	JM734449	JM734410		
180.000	250.000	47.000	45.000	37.000	3.00	2.50	JM736149	JM736110	365	705	1300	1700	194.0	188.0	229.0	240.0	3.60	3.20	(4.7)	0.44	1.36	0.75	4.39	2.3	67790	67720		
184.150	266.700	47.625	46.833	38.100	3.60	3.20	67883	67820	339	703	1200	1600	196.0	191.0	232.0	243.0	3.00	2.50	(8.4)	0.48	1.25	0.69	4.47	2.1	JM736149	JM736110		
187.325	266.700	47.625	46.833	38.100	3.60	3.20	67884	67820	339	703	1200	1600	204.0	198.0	246.0	259.0	3.60	3.20	(10.2)	0.48	1.26	0.69	6.06	2.53	67883	67820		
190.000	260.000	46.000	44.000	36.500	3.00	2.50	JM738249	JM738210	369	723	1200	1700	206.0	201.0	246.0	259.0	3.60	3.20	(10.2)	0.48	1.26	0.69	5.76	2.53	67884	67820		
196.850	254.000	28.575	27.783	21.433	1.60	1.60	L540049	L540010	188	387	1200	1600	206.0	200.0	242.0	252.0	3.00	2.50	(10.1)	0.48	1.26	0.69	4.71	2.18	JM738249	JM738210		
													207.0	205.0	243.0	247.0	1.60	1.60	(14.6)	0.40	1.51	0.83	2.34	1.02	L540049	L540010		

Note: (1) Minus value of load center "a" indicates that the center is located outside of cone backface.

Double-row Tapered Roller Bearings - Outward

Bore Diameter: 25~75mm

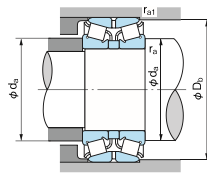
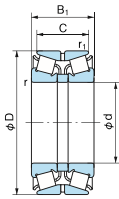

Dynamic equivalent radial load
Fr = XFr + YFa

Fr ≤ e		Fr > e	
X	Y	X	Y
1	Y1	0.67	Y2

Values e, Y1 and Y2 from table.

Static equivalent radial load
P0 = Fr + Y0Fa

Values Y0 from table.

1N=0.102kgf

Boundary dimensions (mm)						Bearing No.	Basic dynamic load rating Cr (N)	Basic static load rating Cor (N)	Abutment and fillet dimensions (mm)				Constant e	Axial load factor			Mass (kg)	Bearing No.
d	D	B1	C	r (min)	r1 (min)				da (min)	Ds (min)	ra (max)	ra1 (max)		Y1	Y2	Y0		
25	62	40	29.5	1.5	0.6	H-25KDE13	68300	84900	33.5	58.5	1.5	0.6	0.83	0.82	1.22	0.80	0.592	H-25KDE13
30	72	45	31.5	1.5	0.6	H-30KDE13	87300	110000	38.5	68	1.5	0.6	0.83	0.82	1.22	0.80	0.872	H-30KDE13
35	80	51	35.5	2	0.6	H-35KDE13	108000	138000	45	76.5	2	0.6	0.83	0.82	1.22	0.80	1.2	H-35KDE13
40	80	45	37.5	1.5	0.6	H-40KBE02	108000	138000	48.5	75	1.5	0.6	0.37	1.80	2.68	1.76	0.954	H-40KBE02
	80	55	43.5	1.5	0.6	H-40KBE22	133000	182000	48.5	75	1.5	0.6	0.37	1.80	2.68	1.76	1.19	H-40KBE22
	90	56	45.5	2	0.6	H-40KBE03	155000	202000	50	82	2	0.6	0.35	1.96	2.91	1.91	1.67	H-40KBE03
	90	56	39.5	2	0.6	H-40KDE13	138000	180000	50	86.5	2	0.6	0.83	0.82	1.22	0.80	1.67	H-40KDE13
45	85	47	37.5	1.5	0.6	H-45KBE02	115000	155000	53.5	80	1.5	0.6	0.40	1.67	2.48	1.63	1.1	H-45KBE02
	85	55	43.5	1.5	0.6	H-45KBE22	134000	188000	53.5	81	1.5	0.6	0.40	1.67	2.48	1.63	1.31	H-45KBE22
	100	60	49.5	2	0.6	45KBE03	193000	256000	55	93	2	0.6	0.35	1.96	2.91	1.91	2.2	45KBE03
	100	60	41.5	2	0.6	45KDE13	163000	214000	55	96	2	0.6	0.83	0.82	1.22	0.80	2.15	45KDE13
50	90	49	39.5	1.5	0.6	50KBE02	131000	183000	58.5	85	1.5	0.6	0.42	1.61	2.39	1.57	1.22	50KBE02
	90	55	43.5	1.5	0.6	50KBE22	146000	211000	58.5	85	1.5	0.6	0.42	1.61	2.39	1.57	1.39	50KBE22
	110	64	51.5	2	0.6	50KBE03	236000	305000	62	102	2	0.6	0.35	1.96	2.91	1.91	2.68	50KBE03
	110	64	43.5	2	0.6	50KDE13	198000	266000	62	105	2	0.6	0.83	0.82	1.22	0.80	3.11	50KDE13
55	100	51	41.5	2	0.6	55KBE02	162000	226000	65	94	2	0.6	0.40	1.67	2.48	1.63	1.6	55KBE02
	100	60	48.5	2	0.6	55KBE22	184000	266000	65	95	2	0.6	0.40	1.67	2.48	1.63	1.87	55KBE22
	120	70	57	2	0.6	55KBE03	256000	341000	67	111	2	0.6	0.35	1.96	2.91	1.91	3.57	55KBE03
	120	70	49	2	0.6	55KDE13	221000	297000	67	113	2	0.6	0.83	0.82	1.22	0.80	3.54	55KDE13
60	110	53	43.5	2	0.6	60KBE02	182000	254000	70	103	2	0.6	0.40	1.67	2.48	1.63	2.04	60KBE02
	110	66	54.5	2	0.6	60KBE22	226000	334000	70	104	2	0.6	0.40	1.67	2.48	1.63	2.57	60KBE22
	130	74	59	2.5	1	60KBE03	297000	401000	74	120	2.5	1	0.35	1.96	2.91	1.91	4.46	60KBE03
	130	74	51	2.5	1	60KDE13	262000	359000	74	124	2.5	1	0.83	0.82	1.22	0.8	4.45	60KDE13
65	120	56	46.5	2	0.6	65KBE02	220000	311000	75	113	2	0.6	0.40	1.67	2.48	1.63	2.84	65KBE02
	120	73	61.5	2	0.6	65KBE22	270000	406000	75	115	2	0.6	0.40	1.67	2.48	1.63	3.4	65KBE22
	140	79	63	2.5	1	65KBE03	349000	478000	79	130	2.5	1	0.35	1.96	2.91	1.91	5.51	65KBE03
	140	79	53	2.5	1	65KDE13	302000	417000	79	133	2.5	1	0.83	0.82	1.22	0.80	5.3	65KDE13
70	125	59	48.5	2	0.6	70KBE02	236000	346000	80	118	2	0.6	0.42	1.61	2.39	1.57	2.87	70KBE02
	125	74	61.5	2	0.6	70KBE22	290000	450000	80	119	2	0.6	0.42	1.61	2.39	1.57	3.7	70KBE22
	150	83	67	2.5	1	70KBE03	394000	546000	84	140	2.5	1	0.35	1.96	2.91	1.91	6.65	70KBE03
	150	83	57	2.5	1	70KDE13	338000	470000	84	142	2.5	1	0.83	0.82	1.22	0.8	6.48	70KDE13
75	130	62	51.5	2	0.6	75KBE02	244000	362000	85	124	2	0.6	0.44	1.55	2.31	1.52	3.12	75KBE02
	130	74	61.5	2	0.6	75KBE22	298000	469000	85	125	2	0.6	0.44	1.55	2.31	1.52	3.85	75KBE22
	160	87	69	2.5	1	75KBE03	429000	594000	89	149	2.5	1	0.35	1.96	2.91	1.91	7.8	75KBE03

Double-row Tapered Roller Bearings - Outward

Bore Diameter: 80~120mm

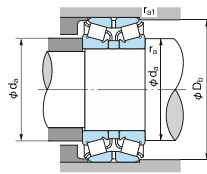
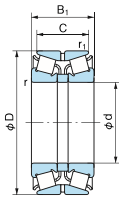

Dynamic equivalent radial load

$P_r = X F_r + Y F_a$

$\frac{F_a}{F_r} \leq e$		$\frac{F_a}{F_r} > e$	
X	Y	X	Y
1	Y ₁	0.67	Y ₂

Values e, Y₁ and Y₂ from table.

Static equivalent radial load

$P_0 = F_r + Y_0 F_a$

Values Y₀ from table.

1N=0.102kgf

Boundary dimensions (mm)						Bearing No.	Basic dynamic load rating Cr (N)	Basic static load rating Cor (N)	Abutment and fillet dimensions (mm)				Constant e	Axial load factor			Mass (kg)	Bearing No.
d	D	B ₁	C	r (min)	r ₁ (min)				d _a (min)	D _b (min)	r _a (max)	r _{a1} (max)		Y ₁	Y ₂	Y ₀		
80	140	64	51.5	2	0.6	80KBE02	277000	405000	92	132	2	0.6	0.42	1.61	2.39	1.57	3.76	80KBE02
	140	78	63.5	2	0.6	80KBE22	347000	542000	92	134	2	0.6	0.42	1.61	2.39	1.57	4.71	80KBE22
	170	92	73	2.5	1	80KBE03	504000	711000	94	159	2.5	1	0.35	1.96	2.91	1.91	9.44	80KBE03
85	150	70	57	2	0.6	85KBE02	313000	463000	97	141	2	0.6	0.42	1.61	2.39	1.57	4.79	85KBE02
	150	86	69	2	0.6	85KBE22	398000	630000	97	142	2	0.6	0.42	1.61	2.39	1.57	6.05	85KBE22
	180	98	77	3	1	85KBE03	522000	733000	103	167	3	1	0.35	1.96	2.91	1.91	11	85KBE03
90	160	74	61	2	0.6	90KBE02	350000	522000	102	150	2	0.6	0.42	1.61	2.39	1.57	5.85	90KBE02
	160	94	77	2	0.6	90KBE22	451000	724000	102	152	2	0.6	0.42	1.61	2.39	1.57	7.53	90KBE22
	190	102	81	3	1	90KBE03	576000	812000	108	177	3	1	0.35	1.96	2.91	1.91	13	90KBE03
95	170	78	63	2.5	1	95KBE02	396000	598000	109	159	2.5	1	0.42	1.61	2.39	1.57	7.01	95KBE02
	170	100	83	2.5	1	95KBE22	533000	877000	109	161	2.5	1	0.42	1.61	2.39	1.57	9.25	95KBE22
	200	108	85	3	1	95KBE03	543000	736000	113	186	3	1	0.35	1.96	2.91	1.91	14.8	95KBE03
100	180	83	67	2.5	1	100KBE02	443000	676000	114	168	2.5	1	0.42	1.61	2.39	1.57	8.33	100KBE02
	180	107	87	2.5	1	100KBE22	596000	990000	114	171	2.5	1	0.42	1.61	2.39	1.57	11.1	100KBE22
	215	112	87	3	1	100KBE03	589000	798000	118	200	3	1	0.35	1.96	2.91	1.91	18.1	100KBE03
105	190	88	70	2.5	1	105KBE02	494000	761000	119	178	2.5	1	0.42	1.61	2.39	1.57	9.87	105KBE02
	190	115	95	2.5	1	105KBE22	672000	1130000	119	180	2.5	1	0.42	1.61	2.39	1.57	13.5	105KBE22
	225	116	91	3	1	105KBE03	636000	864000	123	209	3	1	0.35	1.96	2.91	1.91	20.7	105KBE03
110	180	70	56	2.5	0.6	110KBE031	324000	533000	122	168	2	0.6	0.35	1.92	2.86	1.88	6.43	110KBE031
	180	56	50	2.5	0.6	110KBE131	245000	388000	122	168	2	0.6	0.35	1.95	2.90	1.91	5.13	110KBE131
	200	92	74	2.5	1	110KBE02	556000	868000	124	188	2.5	1	0.42	1.61	2.39	1.57	11.6	110KBE02
	200	121	101	2.5	1	110KBE22	750000	1280000	124	190	2.5	1	0.42	1.61	2.39	1.57	15.9	110KBE22
240	118	93	3	1	110KBE03	824000	1180000	128	222	3	1	0.35	1.96	2.91	1.91	23.8	110KBE03	
120	180	58	46	2.5	0.6	120KBE030	247000	460000	132	169	2	0.6	0.35	1.95	2.90	1.91	4.66	120KBE030
	180	46	41	2.5	0.6	120KBE130	185000	317000	132	170	2	0.6	0.35	1.95	2.90	1.91	3.81	120KBE130
	200	78	62	2.5	0.6	120KBE031	387000	672000	132	185	2	0.6	0.35	1.95	2.90	1.91	9.14	120KBE031
	200	62	55	2.5	0.6	120KBE131	292000	470000	132	184	2	0.6	0.35	1.95	2.90	1.91	7.28	120KBE131
	215	97	78	2.5	1	120KBE02	595000	945000	134	203	2.5	1	0.44	1.55	2.31	1.52	13.9	120KBE02
	215	132	109	2.5	1	120KBE22	806000	1380000	134	204	2.5	1	0.44	1.55	2.31	1.52	19.8	120KBE22
260	128	101	3	1	120KBE03	864000	1220000	138	239	3	1	0.35	1.96	2.91	1.91	30.6	120KBE03	

Double-row Tapered Roller Bearings - Outward

Bore Diameter: 130~170mm

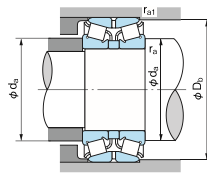
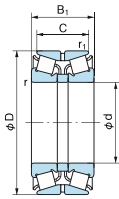

■ Dynamic equivalent radial load
 $F_r = X F_r + Y F_a$

$\frac{F_a}{F_r} \leq e$		$\frac{F_a}{F_r} > e$	
X	Y	X	Y
1	Y ₁	0.67	Y ₂

Values e, Y₁ and Y₂ from table.

■ Static equivalent radial load
 $P_0 = F_r + Y_0 F_a$

Values Y₀ from table.

1N=0.102kgf

Boundary dimensions (mm)						Bearing No.	Basic dynamic load rating C _r (N)	Basic static load rating C _{0r} (N)	Abutment and fillet dimensions (mm)				Constant e	Axial load factor			Mass (kg)	Bearing No.
d	D	B ₁	C	r (min)	r ₁ (min)				d _a (min)	D _a (min)	r _a (max)	r _{a1} (max)		Y ₁	Y ₂	Y ₀		
130	200	65	52	2.5	0.6	130KBE030	319000	618000	142	185	2	0.6	0.35	1.95	2.90	1.91	7.06	130KBE030
	200	52	46	2.5	0.6	130KBE130	239000	425000	142	187	2	0.6	0.35	1.95	2.90	1.91	5.57	130KBE130
	210	80	64	2.5	0.6	130KBE031	424000	723000	142	198	2	0.6	0.36	1.87	2.79	1.83	9.57	130KBE031
	210	64	57	2.5	0.6	130KBE131	322000	535000	142	196	2	0.6	0.36	1.87	2.79	1.83	7.81	130KBE131
	230	98	78.5	3	1	130KBE02	646000	1020000	148	219	3	1	0.44	1.55	2.31	1.52	15.7	130KBE02
	230	145	117.5	3	1	130KBE22	949000	1660000	148	219	3	1	0.44	1.55	2.31	1.52	24.1	130KBE22
	280	137	107.5	4	1.5	130KBE03	965000	1370000	152	255	4	1.5	0.35	1.96	2.91	1.91	38.1	130KBE03
140	210	66	53	2.5	0.6	140KBE030	360000	639000	152	199	2	0.6	0.47	1.43	2.12	1.40	7.18	140KBE030
	210	53	47	2.5	0.6	140KBE130	239000	404000	152	196	2	0.6	0.33	2.03	3.02	1.98	5.85	140KBE130
	225	85	68	3	1	140KBE031	475000	836000	154	212	2.5	1	0.35	1.95	2.90	1.91	11.8	140KBE031
	225	68	61	3	1	140KBE131	360000	564000	154	210	2.5	1	0.35	1.95	2.90	1.91	9.58	140KBE131
	250	102	82.5	3	1	140KBE02	694000	1080000	158	237	3	1	0.44	1.55	2.31	1.52	19.7	140KBE02
	250	153	125.5	3	1	140KBE22	1090000	1920000	158	238	3	1	0.44	1.55	2.31	1.52	30.2	140KBE22
	300	145	115.5	4	1.5	140KBE03	1070000	1520000	162	273	4	1.5	0.35	1.96	2.91	1.91	46.6	140KBE03
150	225	70	56	3	1	150KBE030	377000	703000	164	213	2.5	1	0.33	2.03	3.02	1.98	8.82	150KBE030
	225	56	50	3	1	150KBE130	278000	476000	164	213	2.5	1	0.33	2.03	3.02	1.98	7.09	150KBE130
	250	100	80	3	1	150KBE031	595000	1070000	164	234	2.5	1	0.35	1.95	2.90	1.91	17.6	150KBE031
	250	80	71	3	1	150KBE131	467000	786000	164	233	2.5	1	0.35	1.95	2.90	1.91	14.6	150KBE131
	270	109	87	3	1	150KBE02	799000	1250000	168	255	3	1	0.44	1.55	2.31	1.52	24.6	150KBE02
	270	164	130	3	1	150KBE22	1210000	2130000	168	254	3	1	0.44	1.55	2.31	1.52	38	150KBE22
	320	154	120	4	1.5	150KBE03	1230000	1920000	172	292	4	1.5	0.35	1.96	2.91	1.91	56	150KBE03
160	240	75	60	3	1	160KBE030	406000	756000	174	226	2.5	1	0.33	2.03	3.02	1.98	10.6	160KBE030
	240	60	53	3	1	160KBE130	324000	565000	174	228	2.5	1	0.33	2.03	3.02	1.98	8.71	160KBE130
	270	108	86	3	1	160KBE031	727000	1270000	174	252	2.5	1	0.35	1.95	2.90	1.91	23.1	160KBE031
	270	86	76	3	1	160KBE131	592000	950000	174	252	2.5	1	0.35	1.95	2.90	1.91	18.8	160KBE131
	290	115	91	3	1	160KBE02	827000	1270000	178	269	3	1	0.44	1.55	2.31	1.52	29.9	160KBE02
	290	178	144	3	1	160KBE22	1360000	2420000	178	274	3	1	0.44	1.55	2.31	1.52	47.6	160KBE22
170	260	84	67	3	1	170KBE030	502000	969000	184	244	2.5	1	0.33	2.03	3.02	1.98	14.7	170KBE030
	260	67	60	3	1	170KBE130	382000	642000	184	243	2.5	1	0.33	2.03	3.02	1.98	11.4	170KBE130
	280	110	88	3	1	170KBE031	776000	1390000	184	260	2.5	1	0.33	2.06	3.06	2.01	24.7	170KBE031
	280	88	78	3	1	170KBE131	599000	1050000	184	263	2.5	1	0.33	2.06	3.06	2.01	19.8	170KBE131
	310	125	97	4	1.5	170KBE02	932000	1450000	192	288	4	1.5	0.44	1.55	2.31	1.52	37.5	170KBE02
	310	192	152	4	1.5	170KBE22	1540000	2760000	192	294	4	1.5	0.44	1.55	2.31	1.52	58.8	170KBE22

Double-row Tapered Roller Bearings - Outward

Bore Diameter: 180~280mm

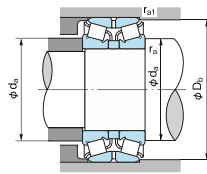
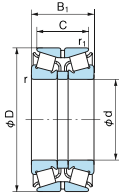

■ Dynamic equivalent radial load
Fr = XFr + YFa

Fr ≤ e		Fr > e	
X	Y	X	Y
1	Y1	0.67	Y2

Values e, Y1 and Y2 from table.

■ Static equivalent radial load
P0 = Fr + Y0Fa

Values Y0 from table.

1N=0.102kgf

Boundary dimensions (mm)						Bearing No.	Basic dynamic load rating Cr (N)	Basic static load rating Cor (N)	Abutment and fillet dimensions (mm)				Constant e	Axial load factor			Mass (kg)	Bearing No.
d	D	B1	C	r (min)	r1 (min)				da (min)	Ds (min)	ra (max)	ra1 (max)		Y1	Y2	Y0		
180	280	93	74	3	1	180KBE030	584000	1080000	194	261	2.5	1	0.33	2.03	3.02	1.98	19.0	180KBE030
	280	74	66	3	1	180KBE130	464000	801000	194	263	2.5	1	0.33	2.03	3.02	1.98	15.5	180KBE130
	300	120	96	4	1.5	180KBE031	894000	1630000	198	279	3	1.5	0.33	2.06	3.06	2.01	31.3	180KBE031
	300	96	85	4	1.5	180KBE131	693000	1240000	198	277	3	1.5	0.33	2.06	3.06	2.01	25.8	180KBE131
	320	127	99	4	1.5	180KBE02	1060000	1470000	202	297	4	1.5	0.45	1.5	2.23	1.47	40.1	180KBE02
	320	192	152	4	1.5	180KBE22	1640000	3030000	202	303	4	1.5	0.45	1.5	2.23	1.47	62.5	180KBE22
190	290	94	75	3	1	190KBE030	632000	1170000	204	274	2.5	1	0.33	2.03	3.02	1.98	20.0	190KBE030
	290	75	67	3	1	190KBE130	487000	866000	204	272	2.5	1	0.32	2.12	3.15	2.07	16.5	190KBE130
	320	130	104	4	1.5	190KBE031	1020000	1860000	208	298	3	1.5	0.35	1.95	2.90	1.91	39.0	190KBE031
	320	104	92	4	1.5	190KBE131	808000	1450000	208	298	3	1.5	0.35	1.95	2.90	1.91	31.9	190KBE131
	340	133	105	4	1.5	190KBE02	1250000	2060000	212	318	4	1.5	0.44	1.55	2.31	1.52	47.8	190KBE02
	340	204	160	4	1.5	190KBE22	1870000	3480000	212	323	4	1.5	0.44	1.55	2.31	1.52	75.1	190KBE22
200	310	103	82	3	1	200KBE030	713000	1380000	212	295	2.5	1	0.33	2.03	3.02	1.98	24.5	200KBE030
	310	82	73	3	1	200KBE130	572000	1040000	214	288	2.5	1	0.32	2.12	3.15	2.07	21.4	200KBE130
	340	140	112	4	1.5	200KBE031	1110000	2040000	218	319	3	1.5	0.35	1.95	2.90	1.91	48.2	200KBE031
	340	112	100	4	1.5	200KBE131	939000	1580000	218	316	3	1.5	0.35	1.95	2.90	1.91	39.6	200KBE131
	360	142	110	4	1.5	200KBE02	1360000	2240000	222	336	4	1.5	0.44	1.55	2.31	1.52	56.5	200KBE02
	360	218	174	4	1.5	200KBE22	2130000	3760000	222	340	4	1.5	0.41	1.66	2.47	1.62	88.2	200KBE22
220	340	113	90	4	1.5	220KBE030	832000	1620000	238	319	3	1.5	0.32	2.12	3.15	2.07	34.2	220KBE030
	340	90	80	4	1.5	220KBE130	677000	1240000	238	318	3	1.5	0.32	2.12	3.15	2.07	27.8	220KBE130
	370	150	120	5	1.5	220KBE031	1330000	2470000	242	343	4	1.5	0.35	1.95	2.90	1.91	60.1	220KBE031
	370	120	107	5	1.5	220KBE131	1070000	1810000	242	346	4	1.5	0.35	1.95	2.90	1.91	49.1	220KBE131
	360	115	92	4	1.5	240KBE030	990000	1980000	258	341	3	1.5	0.32	2.12	3.15	2.07	36.9	240KBE030
	360	92	82	4	1.5	240KBE130	768000	1430000	258	338	3	1.5	0.32	2.12	3.15	2.07	29.6	240KBE130
240	400	160	128	5	1.5	240KBE031	1540000	3060000	262	373	4	1.5	0.35	1.95	2.90	1.91	76.2	240KBE031
	400	128	114	5	1.5	240KBE131	1190000	2180000	262	377	4	1.5	0.35	1.95	2.90	1.91	59.0	240KBE131
	400	130	104	5	1.5	260KBE030	1210000	2480000	282	376	4	1.5	0.32	2.12	3.15	2.07	54.8	260KBE030
	400	104	92	5	1.5	260KBE130	935000	1830000	282	373	4	1.5	0.33	2.03	3.02	1.98	44.6	260KBE130
	440	180	144	5	1.5	260KBE031	2010000	3960000	282	409	4	1.5	0.35	1.95	2.90	1.91	105	260KBE031
	440	144	128	5	1.5	260KBE131	1510000	2880000	282	410	4	1.5	0.35	1.95	2.90	1.91	83.8	260KBE131
280	420	133	106	5	1.5	280KBE030	1250000	2610000	302	394	4	1.5	0.33	2.03	3.02	1.98	58.9	280KBE030
	420	106	94	5	1.5	280KBE130	1010000	1970000	302	395	4	1.5	0.33	2.03	3.02	1.98	46.9	280KBE130
	460	183	146	6	2	280KBE031	2040000	3940000	308	434	5	2	0.35	1.95	2.90	1.91	111	280KBE031
	460	146	130	6	2	280KBE131	1550000	2930000	308	430	5	2	0.35	1.95	2.90	1.91	90.0	280KBE131

Double-row Tapered Roller Bearings - Outward

Bore Diameter: 300~460mm

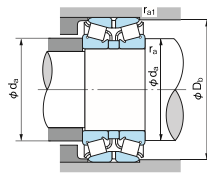
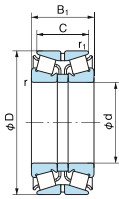

Dynamic equivalent radial load

$F_r = X F_r + Y F_a$

X	$\frac{F_a}{F_r} \leq e$		$\frac{F_a}{F_r} > e$	
	Y		X	Y
1	Y ₁		0.67	Y ₂

Values e, Y₁ and Y₂ from table.

Static equivalent radial load

$P_0 = F_r + Y_0 F_a$
Values Y₀ from table.

1N=0.102kgf

Boundary dimensions (mm)						Bearing No.	Basic dynamic load rating Cr (N)	Basic static load rating Cor (N)	Abutment and fillet dimensions (mm)				Constant e	Axial load factor			Mass (kg)	Bearing No.
d	D	B ₁	C	r (min)	r ₁ (min)				d _a (min)	D _b (min)	r _a (max)	r _{a1} (max)		Y ₁	Y ₂	Y ₀		
300	460	148	118	5	1.5	300KBE030	1630000	3230000	322	433	4	1.5	0.32	2.12	3.15	2.07	80.2	300KBE030
	460	118	105	5	1.5	300KBE130	1290000	2400000	322	436	4	1.5	0.32	2.12	3.15	2.07	64.6	300KBE130
	500	200	160	6	2	300KBE031	2270000	4630000	328	466	5	2	0.35	1.95	2.90	1.91	144	300KBE031
	500	160	142	6	2	300KBE131	1980000	3540000	328	469	5	2	0.35	1.95	2.90	1.91	116	300KBE131
320	480	151	121	5	1.5	320KBE030	1650000	3410000	342	452	4	1.5	0.32	2.12	3.15	2.07	87.7	320KBE030
	480	121	108	5	1.5	320KBE130	1430000	2700000	342	452	4	1.5	0.32	2.12	3.15	2.07	71.6	320KBE130
	540	220	176	6	2	320KBE031	2610000	5390000	348	497	5	2	0.35	1.95	2.90	1.91	190	320KBE031
	540	176	157	6	2	320KBE131	2440000	4570000	348	502	5	2	0.35	1.95	2.90	1.91	154	320KBE131
340	520	165	133	6	2	340KBE030	1930000	4060000	368	491	5	2	0.32	2.12	3.15	2.07	117	340KBE030
	520	133	118	6	2	340KBE130	1550000	3070000	368	489	5	2	0.32	2.12	3.15	2.07	95.3	340KBE130
	580	238	190	6	2	340KBE031	3160000	6340000	368	543	5	2	0.35	1.95	2.90	1.91	244	340KBE031
	580	190	169	6	2	340KBE131	2540000	4620000	368	539	5	2	0.35	1.95	2.90	1.91	198	340KBE131
360	540	169	134	6	2	360KBE030	2020000	4230000	388	512	5	2	0.32	2.12	3.15	2.07	124	360KBE030
	540	134	120	6	2	360KBE130	1660000	3290000	388	510	5	2	0.32	2.12	3.15	2.07	93.0	360KBE130
	600	240	192	6	2	360KBE031	3660000	7230000	388	568	5	2	0.39	1.74	2.59	1.70	254	360KBE031
	600	192	171	6	2	360KBE131	2680000	4880000	388	557	5	2	0.35	1.94	2.90	1.91	206	360KBE131
380	560	171	135	6	2	380KBE030	2240000	4670000	408	531	5	2	0.39	1.74	2.59	1.70	129	380KBE030
	560	135	122	6	2	380KBE130	1740000	3560000	408	530	5	2	0.32	2.12	3.15	2.07	100	380KBE130
	620	243	194	6	2	380KBE031	3490000	7360000	408	578	5	2	0.35	1.95	2.59	1.91	265	380KBE031
	620	194	173	6	2	380KBE131	2870000	5220000	408	582	5	2	0.39	1.74	2.90	1.71	215	380KBE131
400	600	185	148	6	2	400KBE030	2420000	5150000	428	563	5	2	0.32	2.12	3.15	2.07	167	400KBE030
	600	148	132	6	2	400KBE130	1870000	3720000	428	560	5	2	0.32	2.12	3.15	2.07	135	400KBE130
	650	250	200	6	3	400KBE031	4060000	8950000	428	610	5	2.5	0.35	1.95	2.90	1.91	306	400KBE031
	650	200	178	6	3	400KBE131	2980000	5920000	428	605	5	2.5	0.35	1.95	2.90	1.91	243	400KBE131
420	620	188	150	6	2	420KBE030	2700000	5660000	448	589	5	2	0.39	1.74	2.59	1.70	176	420KBE030
	620	150	134	6	2	420KBE130	2010000	4130000	448	590	5	2	0.33	2.03	3.02	1.98	142	420KBE130
	700	280	224	6	3	420KBE031	4810000	9620000	448	659	5	2.5	0.39	1.74	2.59	1.70	400	420KBE031
	700	224	200	6	3	420KBE131	3700000	6880000	448	659	5	2.5	0.39	1.74	2.59	1.70	325	420KBE131
440	650	196	157	6	3	440KBE030	3000000	6370000	468	620	5	2.5	0.39	1.74	2.59	1.70	198	440KBE030
	650	157	140	6	3	440KBE130	2260000	4430000	468	622	5	2.5	0.33	2.03	3.02	1.98	156	440KBE130
	720	283	226	6	3	440KBE031	4940000	10100000	468	679	5	2.5	0.40	1.68	2.51	1.65	418	440KBE031
460	680	204	163	6	3	460KBE030	3220000	6850000	488	646	5	2.5	0.39	1.74	2.59	1.70	232	460KBE030
	680	163	145	6	3	460KBE130	2500000	5340000	488	637	5	2.5	0.37	1.83	2.72	1.78	196	460KBE130
	760	300	240	7.5	4	460KBE031	5680000	11600000	496	718	6	3	0.39	1.74	2.59	1.70	506	460KBE031

Double-row Tapered Roller Bearings - Outward

Bore Diameter: 480~500mm

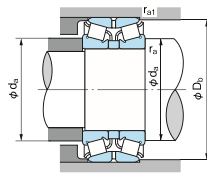
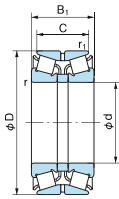

Dynamic equivalent radial load

$P_r = X F_r + Y F_a$

$\frac{F_a}{F_r} \leq e$		$\frac{F_a}{F_r} > e$	
X	Y	X	Y
1	Y_1	0.67	Y_2

Values e , Y_1 and Y_2 from table.

Static equivalent radial load

$P_0 = F_r + Y_0 F_a$

Values Y_0 from table.

1N=0.102kgf

Boundary dimensions (mm)						Bearing No.	Basic dynamic load rating C_r (N)	Basic static load rating C_0r (N)	Abutment and fillet dimensions (mm)				Constant e	Axial load factor			Mass (kg)	Bearing No.
d	D	B_1	C	r (min)	r_1 (min)				d_a (min)	D_b (min)	r_a (max)	r_{a1} (max)		Y_1	Y_2	Y_0		
480	700	206	165	6	3	480KE030	3220000	7230000	508	672	5	2.5	0.33	2.03	3.02	1.98	240	480KE030
	700	165	147	6	3	480KE130	2530000	5300000	508	666	5	2.5	0.33	2.03	3.02	1.98	186	480KE130
	790	310	248	7.5	4	480KE031	5990000	12400000	516	749	6	3	0.39	1.74	2.59	1.70	560	480KE031
	790	248	221	7.5	4	480KE131	4640000	8920000	516	742	6	3	0.39	1.74	2.59	1.70	457	480KE131
500	720	209	167	6	3	500KE030	3500000	7850000	528	690	5	2.5	0.42	1.62	2.41	1.58	258	500KE030
	720	167	149	6	3	500KE130	2580000	5690000	528	679	5	2.5	0.40	1.71	2.54	1.67	210	500KE130
	830	264	235	7.5	4	500KE131	5220000	10900000	536	776	6	3	0.39	1.74	2.59	1.70	559	500KE131

Double-row Tapered Roller Bearings - Inward

Bore Diameter: 110~360mm

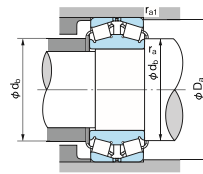
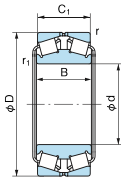

Dynamic equivalent radial load

$F_r = XFr + YFa$

	$\frac{F_a}{F_r} \leq e$	$\frac{F_a}{F_r} > e$
X	Y	X
1	Y ₁	0.67 Y ₂

Values e, Y₁, and Y₂ from table.

Static equivalent radial load

$P_0 = Fr + Y_0 Fa$

Values Y₀ from table.

1N=0.102kgf

Boundary dimensions (mm)							Bearing No.	Basic dynamic load rating Cr (N)	Basic static load rating Cor (N)	Abutment and fillet dimensions (mm)				Constant e	Axial load factor			Mass (kg)	Bearing No.
d	D	B	C ₁	r (min)	r ₁ (min)	d _b (min)				D _a (min)	r _a (max)	r _{a1} (max)	Y ₁		Y ₂	Y ₀			
110	180	56	56	2	2.5	110	300000	505000	128	160	2	2	0.35	1.95	2.90	1.91	5.40	110KBD031	
120	180	46	46	2	2.5	120	229000	424000	138	163	2	2	0.26	2.55	3.80	2.50	4.08	120KBD030	
	200	62	62	2	2.5	120	353000	598000	142	178	2	2	0.35	1.95	2.90	1.91	7.92	120KBD031	
130	200	52	52	2	2.5	130	300000	548000	152	179	2	2	0.27	2.47	3.67	2.41	5.96	130KBD030	
	210	64	64	2	2.5	130	412000	657000	153	185	2	2	0.36	1.87	2.79	1.83	8.41	130KBD031	
140	210	53	53	2	2.5	140	311000	564000	159	188	2	2	0.27	2.47	3.67	2.41	6.45	140KBD030	
	225	68	68	2.5	3	140	486000	807000	160	210	2	2.5	0.40	1.68	2.50	1.64	10.0	140KBD031	
150	225	56	56	2.5	3	150	355000	686000	174	203	2	2.5	0.26	2.55	3.80	2.50	7.78	150KBD030	
	250	80	80	2.5	3	150	593000	955000	179	220	2	2.5	0.35	1.95	2.90	1.91	15.5	150KBD031	
160	240	60	60	2.5	3	160	421000	705000	184	217	2	2.5	0.24	2.79	4.15	2.73	9.22	160KBD030	
	270	86	86	2.5	3	160	678000	1100000	193	237	2	2.5	0.35	1.95	2.90	1.91	19.8	160KBD031	
170	260	67	67	2.5	3	170	521000	956000	195	233	2	2.5	0.31	2.21	3.29	2.16	12.4	170KBD030	
	280	88	88	2.5	3	170	723000	1210000	201	247	2	2.5	0.33	2.03	3.02	1.98	21.6	170KBD031	
180	280	74	74	2.5	3	180	575000	1050000	208	250	2	2.5	0.28	2.43	3.61	2.37	16.8	180KBD030	
	300	96	96	3	4	180	860000	1370000	210	263	2.5	3	0.35	1.95	2.90	1.91	26.5	180KBD031	
190	290	75	75	2.5	3	190	599000	1130000	219	260	2	2.5	0.26	2.55	3.80	2.50	17.7	190KBD030	
	320	104	104	3	4	190	981000	1590000	224	280	2.5	3	0.35	1.95	2.90	1.91	34.0	190KBD031	
200	310	82	82	2.5	3	200	728000	1410000	234	280	2	2.5	0.26	2.55	3.80	2.50	22.9	200KBD030	
	340	112	112	3	4	200	1080000	1840000	244	300	2.5	3	0.35	1.95	2.90	1.91	41.9	200KBD031	
220	340	90	90	3	4	220	804000	1460000	259	306	2.5	3	0.28	2.43	3.61	2.37	28.5	220KBD030	
	370	120	120	4	5	220	1210000	2060000	263	324	3	4	0.35	1.95	2.90	1.91	50.8	220KBD031	
240	360	92	90	3	4	240	915000	1790000	271	325	2.5	3	0.32	2.12	3.15	2.07	32.2	240KBD030	
	400	128	128	4	5	240	1430000	2470000	286	354	3	4	0.35	1.95	2.90	1.91	65.4	240KBD031	
260	400	104	104	4	5	260	1140000	2120000	302	360	3	4	0.25	2.74	4.08	2.68	48.1	260KBD030	
	440	144	144	4	5	260	1890000	3440000	313	386	3	4	0.35	1.95	2.90	1.91	92.2	260KBD031	
280	420	106	106	4	5	280	1190000	2470000	321	370	3	4	0.25	2.69	4.00	2.63	51.9	280KBD030	
	460	118	118	4	5	280	1610000	3150000	350	418	3	4	0.25	2.74	4.08	2.68	78.5	280KBD031	
300	500	160	160	5	6	300	2120000	4240000	356	440	4	5	0.35	1.95	2.90	1.91	129	300KBD031	
	480	121	121	4	5	320	1630000	3180000	368	434	3	4	0.26	2.55	3.80	2.50	77.8	320KBD030	
320	540	176	176	5	6	320	2690000	5280000	378	474	4	5	0.32	2.12	3.15	2.07	167	320KBD031	
	580	190	190	5	6	340	3290000	5470000	401	515	4	5	0.32	2.12	3.15	2.07	202	340KBD031	
340	540	134	134	5	6	360	2050000	3910000	408	488	4	5	0.32	2.12	3.15	2.06	101	360KBD030	
	600	192	192	5	6	360	3360000	6750000	419	528	4	5	0.32	2.12	3.15	2.06	228	360KBD031	

Double-row Tapered Roller Bearings - Inward

Bore Diameter: 380~500mm

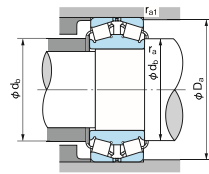
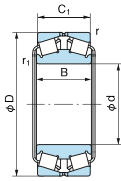

Dynamic equivalent radial load

$F_r = XFr + YFa$

$\frac{F_a}{F_r} \leq e$		$\frac{F_a}{F_r} > e$	
X	Y	X	Y
1	Y_1	0.67	Y_2

Values e, Y_1 , and Y_2 from table.

Static equivalent radial load

$P_0 = Fr + Y_0 Fa$

Values Y_0 from table.

1N=0.102kgf

Boundary dimensions (mm)						Bearing No.	Basic dynamic load rating C_r (N)	Basic static load rating C_0r (N)	Abutment and fillet dimensions (mm)				Constant e	Axial load factor			Mass (kg)	Bearing No.
d	D	B	C_1	r (min)	r_1 (min)				d_b (min)	D_a (min)	r_a (max)	r_{a1} (max)		Y_1	Y_2	Y_0		
380	560	135	135	5	6	380KBD030	2060000	3790000	428	510	4	5	0.27	2.47	3.67	2.41	112	380KBD030
	620	194	194	5	6	380KBD031	3070000	6360000	445	545	4	5	0.32	2.12	3.15	2.07	234	380KBD031
400	600	148	148	5	6	400KBD030	2410000	4960000	452	545	4	5	0.33	2.03	3.02	1.98	143	400KBD030
	650	200	200	6	6	400KBD031	3850000	7810000	458	580	5	5	0.39	1.74	2.59	1.70	265	400KBD031
420	700	224	224	6	6	420KBD031	4710000	8380000	488	623	5	5	0.39	1.74	2.59	1.70	352	420KBD031
440	650	157	157	6	6	440KBD030	2750000	5500000	500	592	5	5	0.28	2.43	3.61	2.37	182	440KBD030
	720	226	226	6	6	440KBD031	4990000	9130000	506	642	5	5	0.39	1.74	2.59	1.70	367	440KBD031
460	680	163	163	6	6	460KBD030	3000000	5660000	510	616	5	5	0.39	1.74	2.59	1.70	197	460KBD030
480	700	165	165	6	6	480KBD030	3060000	6710000	531	625	5	5	0.40	1.68	2.50	1.64	215	480KBD030
500	720	167	167	6	6	500KBD030	3430000	7350000	545	645	5	5	0.39	1.74	2.59	1.70	222	500KBD030



Four-row Tapered Roller Bearings

Tolerance / metric series Page 57
/ inch series Page 60

● Design and Features

Four-row Tapered Roller Bearings are used for the roll necks of rolling mills and are designed to provide the maximum load capacity within the limited space while allowing easy inspection and maintenance.

Pin-type cages and hollow rollers are used in some of the larger bore sizes to maximize load capacity.

● Recommended Fit (cylindrical bore)

Metric series ... Table 1 and 2
Inch series Table 3 and 4

● Bearing Clearance

Cylindrical-bore, Four-row Tapered Roller Bearings used for roll neck of rolling mill have a C2 or smaller clearance. If selection of special radial clearance is required for special service conditions, contact NACHI. Bearing clearance for Four-row Tapered roller bearings is factory-adjusted as a set and the individual parts of a set must be mounted according to the set marks.

Table 1. Four-row Bearing Roll Neck Fits (Metric Series)

Unit: μm

Nominal bearing bore diameter d (mm)		Single plane mean bore diameter deviation Δd_{mp}		Roll neck diameter deviation		Fit clearance		Wear limit of roll neck (Reference)
Over	Incl.	High	Low	High	Low	Min	Max	
80	120	0	-20	-120	-150	100	150	300
120	180	0	-25	-150	-175	125	175	350
180	250	0	-30	-175	-200	145	200	400
250	315	0	-35	-210	-240	175	240	480
315	400	0	-40	-240	-300	200	300	600
400	500	0	-45	-245	-300	200	300	600
500	630	0	-50	-250	-300	200	300	600

Table 2. Four-row Bearing Chock Fits (Metric Series)

Unit: μm

Nominal bearing outside diameter D (mm)		Single plane mean outside diameter deviation ΔD_{mp}		Chock inside diameter deviation		Fit clearance		Wear limit of chock inside diameter (Reference)
Over	Incl.	High	Low	High	Low	Min	Max	
120	150	0	-20	+60	+25	25	80	160
150	180	0	-25	+125	+50	50	150	300
180	250	0	-30	+120	+50	50	150	300
250	315	0	-35	+115	+50	50	150	300
315	400	0	-40	+110	+50	50	150	300
400	500	0	-45	+105	+50	50	150	300
500	630	0	-50	+100	+50	50	150	300
630	800	0	-75	+150	+75	75	225	450

Table 3. Four-row Bearing Roll Neck Fits (Inch Series)

Unit: μm

Nominal bearing bore diameter d (mm)		Single plane mean bore diameter deviation Δd_s		Roll neck diameter deviation		Fit clearance		Wear limit of roll neck (Reference)
Over	Incl.	High	Low	High	Low	Min	Max	
127.000	5.0000	152.400	6.0000	+25	0	-120	-150	120 175 300
152.400	6.0000	203.200	8.0000	+25	0	-150	-175	150 200 400
203.200	8.0000	304.800	12.0000	+25	0	-175	-200	175 225 450
304.800	12.0000	609.600	24.0000	+51	0	-200	-250	200 301 600
609.600	24.0000	914.400	36.0000	+76	0	-250	-325	250 401 800

Table 4. Four-row Bearing Chock Fits (Inch Series)

Unit: μm

Nominal bearing outside diameter D (mm)		Single plane mean outside diameter deviation ΔD_s		Chock inside diameter deviation		Fit clearance		Wear limit of chock inside diameter (Reference)
Over	Incl.	High	Low	High	Low	Min	Max	
304.800	12.0000	609.600	24.0000	+25	0	+75	+50	25 75 300
609.600	24.0000	914.400	36.0000	+76	0	+150	+100	49 150 300
						+225	+150	74 225 450

Four-row Tapered Roller Bearings

Metric Series

Bore Diameter: 100~500mm

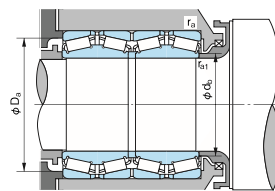
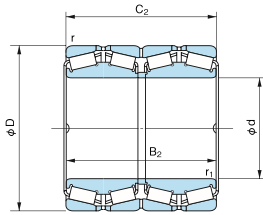

Dynamic equivalent radial load
 $P_r = XFr + YFa$

$\frac{F_a}{F_r} \leq e$		$\frac{F_a}{F_r} > e$	
X	Y	X	Y
1	Y_1	0.67	Y_2

Values of Y_1 , Y_2 and e from table.

Static equivalent radial load
 $P_0 = Fr + Y_0 Fa$

Values Y_0 from table.

1N=0.102kgf

Boundary dimensions (mm)							Bearing No.	Basic dynamic load rating Cr (N)	Basic static load rating Cor (N)	r (min)	r1 (min)	Abutment and fillet dimensions (mm)				Constant e	Axial load factor			Mass (kg) Reference	Bearing No.	
d (mm)	d (inch)	D (mm)	D (inch)	B2 (mm)	B2 (inch)	C2 (mm)						C2 (inch)	db	Da	ra (max)		ra1 (max)	Y1	Y2			Y0
100	3.9370	140	5.5118	104	4.0945	104	4.0945	100KBV039	300000	725000	2	2	108	130	2	2	0.32	2.12	3.15	2.07	5.0	100KBV039
110	4.3307	155	6.1023	114	4.4882	114	4.4882	110KBV039	365000	790000	2.5	2.5	120	145	2	2	0.40	1.68	2.50	1.64	6.4	110KBV039
120	4.7244	170	6.6929	124	4.8819	124	4.8819	120KBV039	435000	910000	2.5	2.5	130	160	2	2	0.32	2.12	3.15	2.07	8.5	120KBV039
130	5.1181	184	7.2441	134	5.2756	134	5.2756	130KBV039	555000	1330000	2.5	2.5	140	174	2	2	0.32	2.12	3.15	2.07	12.3	130KBV039
140	5.5118	198	7.7952	144	5.6693	144	5.6693	140KBV039	580000	1330000	2.5	2.5	153	184	2	2	0.29	2.32	3.45	2.26	13.3	140KBV039
150	5.9055	212	8.3465	155	6.1024	155	6.1024	150KBV039	680000	1550000	2.5	2.5	161	200	2	2	0.40	1.68	2.50	1.64	15.0	150KBV039
160	6.2992	226	8.8976	165	6.4961	165	6.4961	160KBV039	725000	1950000	2.5	2.5	173	208	2	2	0.35	1.95	2.90	1.91	20.2	160KBV039
170	6.6929	240	9.4488	175	6.8898	175	6.8898	170KBV039	915000	2220000	2.5	2.5	183	225	2	2	0.32	2.12	3.15	2.07	23.7	170KBV039
180	7.0866	254	10.0000	185	7.2835	185	7.2835	180KBV039	980000	2410000	2.5	2.5	193	235	2	2	0.40	1.68	2.50	1.64	28.0	180KBV039
190	7.4803	268	10.5512	196	7.7165	196	7.7165	190KBV039	1030000	2760000	2.5	2.5	204	245	2	2	0.47	1.43	2.12	1.40	33.0	190KBV039
200	7.8740	282	11.1024	206	8.1102	206	8.1102	200KBV039	1290000	3400000	2.5	2.5	215	263	2	2	0.40	1.68	2.50	1.64	49.2	200KBV039
220	8.6614	310	12.2047	226	8.8976	226	8.8976	220KBV039	1500000	4000000	3	3	234	296	2.5	2.5	0.35	1.95	2.90	1.91	52.7	220KBV039
240	9.4488	338	13.3071	248	9.7638	248	9.7638	240KBV039	1740000	4450000	3	3	260	310	2.5	2.5	0.29	2.32	3.45	2.26	68.3	240KBV039
260	10.2362	368	14.4882	268	10.5512	268	10.5512	260KBV039	2010000	5750000	4	4	282	348	3	3	0.33	2.03	3.02	1.98	90.0	260KBV039
280	11.0236	395	15.5512	288	11.3386	288	11.3386	280KBV039	2540000	7050000	4	4	300	374	3	3	0.33	2.03	3.02	1.98	108	280KBV039
300	11.8110	424	16.6929	310	12.2047	310	12.2047	300KBV039	2600000	6800000	4	4	320	394	3	3	0.35	1.95	2.90	1.91	137	300KBV039
320	12.5984	460	18.1102	338	13.3071	338	13.3071	320KBV039	3100000	8800000	4	4	340	428	3	3	0.35	1.95	2.90	1.91	183	320KBV039
340	13.3858	480	18.8976	350	13.7795	350	13.7795	340KBV039	3400000	10100000	5	5	362	458	4	4	0.29	2.32	3.45	2.26	198	340KBV039
360	14.1732	508	20.0000	370	14.5669	370	14.5669	360KBV039	4050000	11900000	5	5	382	486	4	4	0.40	1.68	2.50	1.64	233	360KBV039
380	14.9606	536	21.1024	390	15.3543	390	15.3543	380KBV039	4450000	13600000	5	5	408	500	4	4	0.40	1.68	2.50	1.64	271	380KBV039
400	15.7480	564	22.2047	412	16.2205	412	16.2205	400KBV039	4700000	14000000	5	5	422	542	4	4	0.36	1.87	2.79	1.83	317	400KBV039
420	16.5354	592	23.3071	432	17.0079	432	17.0079	420KBV039	4900000	14000000	5	5	450	556	4	4	0.36	1.87	2.79	1.83	366	420KBV039
440	17.3228	620	24.4094	454	17.8740	454	17.8740	440KBV039	6500000	19900000	6	6	474	574	5	5	0.33	2.03	3.02	1.98	422	440KBV039
460	18.1102	650	25.5906	474	18.6614	474	18.6614	460KBV039	6800000	19600000	6	6	488	622	5	5	0.33	2.03	3.02	1.98	487	460KBV039
480	18.8976	678	26.6929	494	19.4488	494	19.4488	480KBV039	7350000	22900000	6	6	515	637	5	5	0.33	2.02	3.01	1.97	552	480KBV039
500	19.6850	705	27.7559	515	20.2756	515	20.2756	500KBV039	7650000	24000000	6	6	528	677	5	5	0.33	2.03	3.02	1.98	650	500KBV039

Remarks: 1. Regarding four-row tapered roller bearings except above-listed, please contact NACHI.
 2. When using four-row tapered roller bearings, please contact NACHI.

Four-row Tapered Roller Bearings

Inch Series

Bore Diameter: 136.525~609.600mm

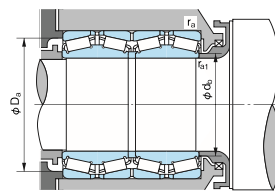
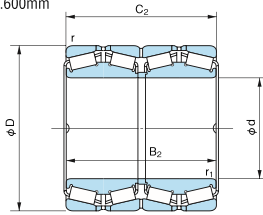

Dynamic equivalent radial load

$F_r = XFr + YFa$

$\frac{F_a}{F_r} \leq e$		$\frac{F_a}{F_r} > e$	
X	Y	X	Y
1	Y ₁	0.67	Y ₂

Values of Y₁, Y₂ and e from table.

Static equivalent radial load

$P_0 = Fr + Y_0 Fa$
Values Y₀ from table.

1N=0.102kgf

Boundary dimensions (mm)							Bearing No.	Basic dynamic load rating Cr (N)	Basic static load rating Cor (N)	Abutment and fillet dimensions (mm)				Constant e	Axial load factor			Mass (kg) Reference	Reference Bearing No.	Bearing No.			
d (mm)	d (inch)	D (mm)	D (inch)	B ₂ (mm)	B ₂ (inch)	C ₂ (mm)				C ₂ (inch)	r (min)	r ₁ (min)	d _b		D _a	r _a (max)	r _{a1} (max)				Y ₁	Y ₂	Y ₀
136.525	5.3750	190.500	7.5000	161.925	6.3750	161.925	6.3750	B26417	715000	1900000	3.3	1.6	147	183	1.5	3.2	0.32	2.10	3.13	2.06	14.9	48393D/48320/48320D	B26417
139.700	5.5000	200.025	7.8750	157.165	6.1876	160.340	6.3126	B28906	720000	2020000	3.3	0.8	147	182	0.8	3.2	0.34	2.01	2.99	1.97	17.7	48680D/48620/48620D	B28906
152.400	6.0000	222.250	8.7500	174.625	6.8750	174.625	6.8750	C21017	910000	2070000	1.6	1.6	164	210	1.5	1.5	0.33	2.02	3.01	1.98	22.7	M231649D/M231610/M231610D	C21017
165.100	6.5000	225.425	8.8750	168.275	6.6250	168.275	6.6250	B25971	755000	2270000	3.2	0.8	175	207	0.8	3.2	0.38	1.76	2.63	1.72	20.2	46791D/46720/46721D	B25971
177.800	7.0000	247.650	9.7500	192.088	7.5625	192.088	7.5625	C20498	990000	2720000	3.3	1.5	190	229	1.5	3.2	0.44	1.54	2.29	1.50	29.0	67791D/67720/67721D	C20498
190.500	7.5000	266.700	10.5000	187.325	7.3750	188.912	7.4375	C19114	1030000	2900000	3.3	1.5	204	246	1.5	3.2	0.47	1.43	2.12	1.40	37.7	67885D/67820/67820D	C19114
244.475	9.6250	327.025	12.8750	193.675	7.6250	193.675	7.6250	C27913	1370000	3550000	3.3	1.5	258	309	1.5	3.2	0.32	2.10	3.13	2.06	43.0	LM247748D/LM247710/LM247710D	C27913
254.000	10.0000	358.775	14.1250	269.875	10.6250	269.875	10.6250	C27916	2120000	5800000	3.4	1.6	275	335	1.5	3.2	0.33	2.02	3.01	1.98	85.5	M249748D/M249710/M249710D	C27916
260.350	10.2500	422.275	16.6250	314.325	12.3750	317.500	12.5000	C22144	2980000	7150000	3.3	6.4	297	404	6.4	3.2	0.33	2.03	3.02	1.98	178	HM252348D/HM252310/HM252310D	C22144
266.700	10.5000	355.600	14.0000	230.188	9.0625	228.600	9.0000	C19619	1490000	4700000	3.2	1.6	277	337	1.5	3.2	0.37	1.80	2.69	1.76	65.6	76590D/76520/76520D	C19619
266.700	10.5000	355.600	14.0000	230.188	9.0625	228.600	9.0000	C29167	1790000	5200000	3.3	1.5	280	335	1.5	3.2	0.31	2.15	3.20	2.10	64.4	LM451349D/LM451310/LM451310D	C29167
279.400	11.0000	393.700	15.5000	269.875	10.6250	269.875	10.6250	C19116	1920000	5300000	6.4	1.5	297	357	1.5	6.4	0.40	1.68	2.50	1.64	103	EE135111D/135155/135156XD	C19116
285.750	11.2500	380.898	14.9960	244.475	9.6250	244.475	9.6250	C27768	1870000	6300000	3.3	1.5	296	362	1.5	3.2	0.43	1.57	2.34	1.53	84.3	LM654648D/LM654610/LM654610D	C27768
304.800	12.0000	419.100	16.5000	269.875	10.6250	269.875	10.6250	C24618	2460000	7050000	6.4	1.5	320	383	1.5	6.4	0.33	2.03	3.02	1.98	110	M257149D/M257110/M257110D	C24618
333.375	13.1250	469.900	18.5000	342.900	13.5000	342.900	13.5000	C21093	3450000	9900000	3.2	3.2	352	451	3.2	3.2	0.33	2.02	3.01	1.97	193	HM261049D/HM261010/HM261010D	C21093
343.052	13.5060	457.098	17.9960	254.000	10.0000	254.000	10.0000	C29794	2480000	7150000	3.3	1.5	356	428	1.5	3.2	0.45	1.49	2.21	1.45	113	LM761649D/LM761610/LM761610D	C29794
346.075	13.6250	488.950	19.2500	358.775	14.1250	358.775	14.1250	C21179	3950000	11600000	3.3	3.3	365	452	3.2	3.2	0.34	2.01	2.99	1.97	208	HM262749D/HM262710/HM262710D	C21179
384.175	15.1250	546.100	21.5000	400.050	15.7500	400.050	15.7500	E17237	5750000	16600000	6.4	3.3	414	507	3.2	6.4	0.33	2.02	3.01	1.98	308	HM266449D/HM266410/HM266410D	E17237
406.400	16.0000	546.100	21.5000	288.925	11.3750	288.925	11.3750	E21147	3050000	8500000	6.4	1.5	427	510	1.5	6.4	0.48	1.42	2.11	1.38	186	LM767749D/LM767710/LM767710D	E21147
431.800	17.0000	571.500	22.5000	279.400	11.0000	279.400	11.0000	E12751	2990000	9550000	3.3	1.5	452	540	1.5	3.2	0.39	1.75	2.60	1.71	191	LM869449D/LM869410/LM869410D	E12751
447.675	17.6250	635.000	25.0000	463.550	18.2500	463.550	18.2500	E17442	6700000	20500000	6.4	3.3	466	599	3.2	6.4	0.33	2.03	3.02	1.98	491	M270749D/M270710/M270710D	E17442
457.200	18.0000	596.900	23.5000	276.225	10.8750	279.400	11.0000	E23231	2950000	9900000	3.3	1.5	478	567	1.5	3.2	0.47	1.43	2.12	1.39	200	L770847D/L770810/L770810D	E23231
479.425	18.8750	679.450	26.7500	495.300	19.5000	495.300	19.5000	E17717	6450000	18900000	6.4	3.2	510	633	3.2	6.4	0.33	2.02	3.01	1.97	590	M272749D/M272710/M272710D	E17717
482.600	19.0000	615.950	24.2500	330.200	13.0000	330.200	13.0000	E24206	3600000	11900000	6.4	3.4	501	579	3.2	6.4	0.33	2.03	3.02	1.98	251	LM272249D/LM272210/LM272210D	E24206
482.600	19.0000	647.700	25.5000	417.512	16.4375	417.512	16.4375	E12372	5950000	14800000	6.4	3.3	505	611	3.2	6.4	0.33	2.03	3.02	1.98	432	M272647D/M272610/M272610D	E12372
488.950	19.2500	660.400	26.0000	365.125	14.3750	361.950	14.2500	E12371	5250000	19900000	6.4	8.0	525	624	7.8	6.4	0.31	2.20	3.27	2.15	347	EE640193D/640260/640261D	E12371
571.500	22.5000	812.800	32.0000	593.725	23.3750	593.725	23.3750	E23120	10300000	34000000	6.4	3.3	608	776	3.2	6.4	0.33	2.02	3.01	1.98	1020	M278749D/M278710/M278710D	E23120
609.600	24.0000	787.400	31.0000	361.950	14.2500	361.950	14.2500	E11996	4800000	17300000	6.4	3.3	637	747	3.2	6.4	0.37	1.82	2.70	1.78	460	EE649241D/649310/649311D	E11996

Remarks: 1. Regarding four-row tapered roller bearings except above-listed, please contact NACHI.
2. When using four-row tapered roller bearings, please contact NACHI.



Spherical Roller Bearings

Tolerance Page 52
 Internal clearance Page 64
 Heat-stabilized treatment Page 22
 Adapter sleeves Page 592
 Withdrawal sleeves Page 592

• Design and configurations

Spherical Roller Bearings are particularly suitable for applications where misalignment can arise from error in mounting or from shaft deflection. NACHI Spherical Roller Bearings are manufactured in a number of design and

material configurations depending on the type of application and size of the bearing. See Table 1 for the roller, the guide ring and cage design for NACHI Spherical Roller Bearings. They can sustain radial and axial loads.

Table 1. Design and configurations

Series	Type	EX	EX1	E	E2	E	AEX	AX	A2X	AX
239						20, 26, 44~1060		28~40		
230				20~36		38~1000		20~36	38~48	
240			24~36			38~600, 670, 800				24~36
231			20~34			36~800		20~34	36~48	
241			22~32			36~500				22~34
222	05~30			32	32	34~68	05~30		32	
232			18, 20~30	16, 17, 19		32~600		20~30	32~40	
213			11~22	04~10, 24				06~22		
223		08~26				28~60	07~26		28, 30	
Cross section										
Roller	Symmetric			Symmetric		Nonsymmetric		Nonsymmetric		
Center guide	Floating ring			Inner ring rib		Inner ring rib		Inner ring rib		
Cage	Pressed steel			Machined high strength brass		Machined high strength brass		Pressed high strength brass		

● Attention

- (1) For high axial load applications, the axial load F_a must not exceed 0.6 of the radial load F_r . If the axial load exceeds 0.6 F_r , contact NACHI engineers for design assistance.
- (2) For applications where oscillating loads (such as shaker screen applications) or high speed is involved, contact NACHI for design assistance.
- (3) In very lightly loaded or no load conditions, sliding motion can occur which could damage the bearing.
To prevent this, bearings must be subjected to a load greater than 0.02 C_r (basic dynamic load rating).
- (4) The material coefficient number of the bearing is taken into consideration for the dynamic load rating.
* This only applies to spherical roller bearing.

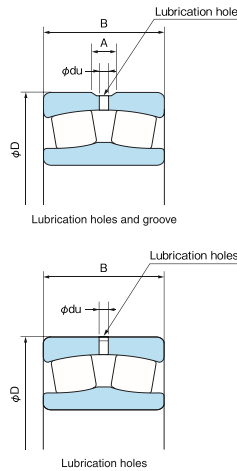

● Lubrication Holes and Groove

The outer ring of Spherical Roller Bearings are often made with lubrication holes and a groove for feeding lubricant. The outer ring may also be configured with oil holes only depending on fitting, mounting, or service conditions. Table 2 shows the symbols for lubrication holes and grooves. Hole diameter, groove width and hole count are according to the dimensions table. Improved heat treatment technology allows for operation at 200°C without change in dimensions.

Table 2. Lubrication holes and groove

Modification to outer ring	Suffix	Part No. Example
Lubrication holes and groove	W33	22330E W33
Lubrication holes	W20	22330E W20

● Misalignment

Maximum permissible misalignment angle is about 2° under general service conditions. But its angle will vary with the series, service condition and surrounding structure. As rotational speed increases, misaligned bearings will tend to generate more noise. Due to noise constraints, the practical maximum misalignment in a bearing may be considerably less than the maximum permissible misalignment.

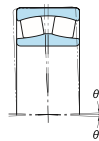

● Mounting bearings with tapered bore

Mounting bearings with a tapered bore requires some experience and technique. Bearings with tapered bore are always mounted with an interference fit on the shaft. To measure the amount of interference fit on the shaft, the axial displacement of the inner ring or

the reduction of radial internal clearance due to the interference fit can be used. Generally, the measurement of reduction in radial internal clearance is a more reliable method than measurement of the axial displacement of the inner ring.

Unit: mm

Nominal bore diameter d	Incl.	Radial clearance reduction		Axial displacement (°)				Necessary minimum internal clearance after mounting (°) (for initial clearance range)		
				Taper						
				1 : 12		1 : 30				
Over	Min	Max	Min	Max	Normal	C3	C4			
24	30	0.015	0.020	0.3	0.35	—	—	0.015	0.020	0.035
30	40	0.020	0.025	0.35	0.4	—	—	0.015	0.025	0.040
40	50	0.025	0.030	0.34	0.45	—	—	0.020	0.030	0.050
50	65	0.030	0.040	0.45	0.6	—	—	0.025	0.035	0.055
65	80	0.040	0.050	0.6	0.75	—	—	0.025	0.040	0.070
80	100	0.045	0.060	0.7	0.9	1.7	2.2	0.035	0.050	0.080
100	120	0.050	0.070	0.75	1.1	1.9	2.7	0.050	0.065	0.100
120	140	0.065	0.090	1.1	1.4	2.7	3.5	0.055	0.080	0.110
140	160	0.075	0.100	1.2	1.6	3.0	4.0	0.055	0.090	0.130
160	180	0.080	0.110	1.3	1.7	3.2	4.2	0.060	0.100	0.150
180	200	0.090	0.130	1.4	2.0	3.5	5.0	0.070	0.100	0.160
200	225	0.100	0.140	1.6	2.2	4.0	5.5	0.080	0.120	0.180
225	250	0.110	0.150	1.7	2.4	4.2	6.0	0.090	0.130	0.200
250	280	0.120	0.170	1.9	2.7	4.7	6.7	0.100	0.140	0.220
280	315	0.130	0.190	2.0	3.0	5.0	7.5	0.110	0.150	0.240
315	355	0.150	0.210	2.4	3.3	6.0	8.2	0.120	0.170	0.260
355	400	0.170	0.230	2.6	3.6	6.5	9.0	0.130	0.190	0.290
400	450	0.200	0.260	3.1	4.0	7.7	10	0.130	0.200	0.310
450	500	0.210	0.280	3.3	4.4	8.2	11	0.160	0.230	0.350
500	560	0.240	0.320	3.7	5.0	9.2	12.5	0.170	0.250	0.360
560	630	0.260	0.350	4.0	5.4	10	13.5	0.200	0.290	0.410
630	710	0.300	0.400	4.6	6.2	11.5	15.5	0.210	0.310	0.450
710	800	0.340	0.450	5.3	7.0	13.3	17.5	0.230	0.350	0.510
800	900	0.370	0.500	5.7	7.8	14.3	19.5	0.270	0.390	0.570
900	1000	0.410	0.550	6.3	8.5	15.8	21	0.300	0.430	0.640
1000	1120	0.450	0.600	6.8	9.0	17	23	0.320	0.480	0.700
1120	1250	0.490	0.650	7.4	9.8	18.5	25	0.340	0.540	0.770

Notes: (°) The values are applied for mounting on solid shaft. In case of hollow shaft, larger axial displacement should be applied.
(°) In following cases, please make sure radial internal clearance after mounting. - Initial radial clearance is less than (bore diameter deviation) × 0.5 - Temperature difference exists between inner ring and outer ring under operation. - Internal clearance after mounting must be over these values.

Spherical Roller Bearings

Bore Diameter: 20~50mm

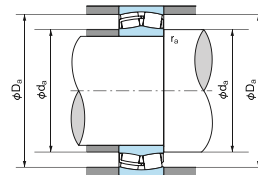
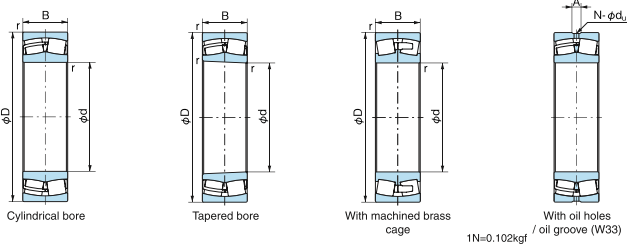

Dynamic equivalent radial load

$F_r = XFr + YFa$

$\frac{F_r}{Fr} \leq e$		$\frac{F_r}{Fr} > e$	
X	Y	X	Y
1	Y ₁	0.67	Y ₂

Values of Y₁, Y₂ and e from table.

Static equivalent radial load

$P_0 = Fr + Y_0 Fa$

Values Y₀ from table.

Boundary dimensions (mm)				Bearing No.		Basic dynamic load rating Cr (N)	Basic static load rating Cor (N)	Limiting speed (min ⁻¹)		Dimensions of lubrication holes and grooves			Abutment and fillet dimensions (mm)			Constant e	Axial load factor			Mass (kg) Cylindrical bore (Reference)	Bearing No.		
d	D	B	r (min)	Cylindrical bore	Tapered bore			Grease lubrication	Oil lubrication	Hole diameter φ _h	Groove width A	Hole count N	d _a (min)	D _a (max)	r _a (max)		Y ₁	Y ₂	Y ₀		Cylindrical bore	Tapered bore	
20	52	15	1.1	21304E	21304EK	47000	33500	11,000	14,000		3	6	4	27.0	45.0	1.0	0.31	2.20	3.27	2.15	0.18	21304E	21304EK
	52	18	1	22205EX	22205EXK	63000	48000	10,500	13,000		3	5	4	30.5	46.5	1.0	0.35	1.91	2.85	1.87	0.19	22205EX	22205EXK
25	52	18	1	22205AEX	22205AEXK	48500	34500	13,300	16,500		3	5	4	30.5	46.5	1.0	0.43	1.57	2.33	1.53	0.18	22205AEX	22205AEXK
	62	17	1.1	21305E	21305EK	64000	47500	9,000	11,500		6	6	4	32.0	53.0	1.0	0.28	2.39	3.56	2.34	0.29	21305E	21305EK
30	62	20	1	22206EX	22206EXK	84500	65000	8,500	11,000		3	5	4	35.5	56.5	1.0	0.33	2.04	3.04	2.00	0.30	22206EX	22206EXK
	62	20	1	22206AEX	22206AEXK	68000	48500	11,200	14,400		3	5	4	35.5	56.5	1.0	0.40	1.70	2.53	1.66	0.29	22206AEX	22206AEXK
	72	19	1.1	21306E	21306EK	83000	62500	8,000	9,500		3	5	4	38.0	65.0	1.0	0.27	2.49	3.71	2.43	0.43	21306E	21306EK
	72	19	1.1	21306AX	21306AXK	73000	50900	9,700	12,700		3	5	4	38.0	65.0	1.0	0.35	1.95	2.90	1.90	0.43	21306AX	21306AXK
35	72	23	1.1	22207EX	22207EXK	112000	88500	7,500	9,500		3	6	4	42.0	65.0	1.0	0.32	2.10	3.13	2.06	0.46	22207EX	22207EXK
	72	23	1.1	22207AEX	22207AEXK	94500	70000	9,600	12,400		3	6	4	42.0	65.0	1.0	0.39	1.74	2.60	1.71	0.46	22207AEX	22207AEXK
	80	21	1.5	21307E	21307EK	96000	76000	7,000	8,500		3	5	4	44.0	71.0	1.5	0.27	2.49	3.71	2.43	0.57	21307E	21307EK
	80	21	1.5	21307AX	21307AXK	89000	63100	9,000	11,200		3	5	4	44.0	71.0	1.5	0.33	2.03	3.03	1.99	0.56	21307AX	21307AXK
40	80	31	1.5	22307AEX	22307AEXK	145000	107000	9,000	11,500		3	6	4	43.5	71.5	1.5	0.48	1.41	2.10	1.38	0.78	22307AEX	22307AEXK
	80	23	1.1	22208EX	22208EXK	126000	102000	6,700	8,500		3	6	4	47.0	73.0	1.0	0.28	2.37	3.53	2.32	0.56	22208EX	22208EXK
	80	23	1.1	22208AEX	22208AEXK	106000	81000	8,500	10,900		3	6	4	47.0	73.0	1.0	0.34	1.99	2.96	1.94	0.56	22208AEX	22208AEXK
	90	23	1.5	21308E	21308EK	119000	95500	6,000	7,500		3	5	4	50.0	81.0	1.5	0.26	2.55	3.80	2.50	0.78	21308E	21308EK
45	90	23	1.5	21308AX	21308AXK	116000	84400	7,500	9,750		3	5	4	50.0	81.0	1.5	0.32	2.09	3.11	2.04	0.79	21308AX	21308AXK
	90	33	1.5	22308EX	22308EXK	185000	151000	5,300	6,700		4	7	4	48.5	81.5	1.5	0.37	1.83	2.72	1.79	1.07	22308EX	22308EXK
	90	33	1.5	22308AEX	22308AEXK	172000	134000	7,800	10,000		4	7	4	48.5	81.5	1.5	0.43	1.55	2.31	1.54	1.05	22308AEX	22308AEXK
	85	23	1.1	22209EX	22209EXK	133000	110000	6,000	7,500		3	6	4	52.0	78.0	1.0	0.26	2.55	3.80	2.50	0.61	22209EX	22209EXK
	85	23	1.1	22209AEX	22209AEXK	113000	85500	7,900	10,200		3	6	4	52.0	78.0	1.0	0.31	2.15	3.21	2.11	0.60	22209AEX	22209AEXK
	100	25	1.5	21309E	21309EK	150000	124000	5,000	6,300		3	5	4	55.0	92.0	1.5	0.26	2.62	3.90	2.56	1.05	21309E	21309EK
	100	25	1.5	21309AX	21309AXK	143000	105000	6,750	9,000		3	5	4	55.0	92.0	1.5	0.31	2.16	3.22	2.11	1.05	21309AX	21309AXK
	100	36	1.5	22309EX	22309EXK	230000	182000	4,500	5,600		4	8	4	53.5	91.5	1.5	0.37	1.83	2.72	1.79	1.41	22309EX	22309EXK
50	100	36	1.5	22309AEX	22309AEXK	208000	157000	7,050	9,150		4	8	4	53.5	91.5	1.5	0.43	1.57	2.34	1.54	1.41	22309AEX	22309AEXK
	90	23	1.1	22210EX	22210EXK	142000	122000	5,600	7,100		3	6	4	57.0	83.0	1.0	0.24	2.79	4.15	2.73	0.65	22210EX	22210EXK
	90	23	1.1	22210AEX	22210AEXK	119000	93500	7,350	9,600		3	6	4	57.0	83.0	1.0	0.29	2.34	3.48	2.28	0.65	22210AEX	22210AEXK
	110	27	2	21310E	21310EK	178000	151000	4,500	5,600		3	5	4	61.0	101.0	2.0	0.25	2.71	4.04	2.65	1.36	21310E	21310EK
	110	27	2	21310AX	21310AXK	170000	127000	6,000	8,250		3	5	4	61.0	101.0	2.0	0.30	2.24	3.34	2.19	1.36	21310AX	21310AXK
	110	40	2	22310EX	22310EXK	280000	235000	4,300	5,300		4	8	4	60.0	100.0	2.0	0.36	1.85	2.75	1.81	1.92	22310EX	22310EXK
110	40	2	22310AEX	22310AEXK	254000	205000	6,300	8,250		4	8	4	60.0	100.0	2.0	0.42	1.62	2.42	1.59	1.88	22310AEX	22310AEXK	

Note: Suffix K or K30 means tapered bore (1/12 or 1/30).

Spherical Roller Bearings

Bore Diameter: 55~75mm

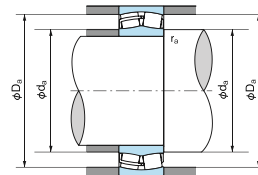
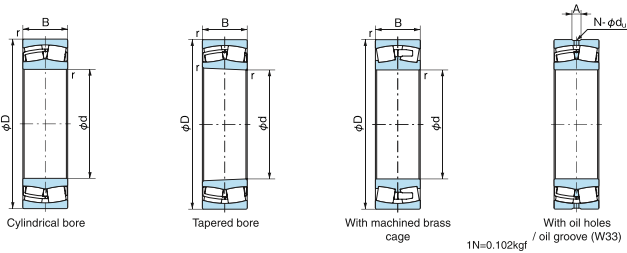

Dynamic equivalent radial load

$F_r = XFr + YFa$

$\frac{Fa}{Fr} \leq e$		$\frac{Fa}{Fr} > e$	
X	Y	X	Y
1	Y ₁	0.67	Y ₂

Values of Y₁, Y₂ and e from table.

Static equivalent radial load

$P_0 = Fr + Y_0 Fa$

Values Y₀ from table.

Boundary dimensions (mm)				Bearing No.		Basic dynamic load rating Cr (N)	Basic static load rating Cor (N)	Limiting speed (min ⁻¹)		Dimensions of lubrication holes and grooves			Abutment and fillet dimensions (mm)			Constant e	Axial load factor			Mass (kg) Cylindrical bore (Reference)	Bearing No.	
d	D	B	r (min)	Cylindrical bore	Tapered bore			Grease lubrication	Oil lubrication	Hole diameter φ _h	Groove width A	Hole count N	d _a (min)	D _a (max)	r _a (max)		Y ₁	Y ₂	Y ₀		Cylindrical bore	Tapered bore
55	100	25	1.5	22211EX	22211EXK	171000	144000	5,300	6,700	3	6	4	63.5	91.5	1.5	0.24	2.84	4.23	2.78	0.88	22211EX	22211EXK
	100	25	1.5	22211AEX	22211AEXK	150000	118000	6,750	8,550	3	6	4	63.5	91.5	1.5	0.29	2.34	3.48	2.28	0.89	22211AEX	22211AEXK
	120	29	2	21311EX1	21311EX1K	200000	165000	4,500	5,600	3	5	4	65.0	110.0	2.0	0.25	2.71	4.03	2.65	1.70	21311EX1	21311EX1K
	120	29	2	21311AX	21311AXK	206000	171000	6,000	7,500	3	5	4	65.0	110.0	2.0	0.29	2.32	3.45	2.27	1.77	21311AX	21311AXK
	120	43	2	22311EX	22311EXK	325000	263000	3,800	4,800	4	8	4	65.0	110.0	2.0	0.36	1.85	2.75	1.81	2.40	22311EX	22311EXK
	120	43	2	22311AEX	22311AEXK	294000	227000	6,000	7,650	4	8	4	65.0	110.0	2.0	0.43	1.56	2.33	1.53	2.39	22311AEX	22311AEXK
60	110	28	1.5	22212EX	22212EXK	210000	179000	4,800	6,000	3	6	4	68.5	101.5	1.5	0.25	2.74	4.08	2.68	1.20	22212EX	22212EXK
	110	28	1.5	22212AEX	22212AEXK	179000	144000	6,150	7,800	3	6	4	68.5	101.5	1.5	0.29	2.29	3.41	2.24	1.22	22212AEX	22212AEXK
	130	31	2.1	21312EX1	21312EX1K	238000	193000	3,800	4,800	3	5	4	72.0	118.0	2.0	0.24	2.78	4.14	2.72	2.10	21312EX1	21312EX1K
	130	31	2.1	21312AX	21312AXK	228000	192000	5,250	6,750	3	5	4	72.0	118.0	2.0	0.29	2.36	3.52	2.31	2.19	21312AX	21312AXK
	130	46	2.1	22312EX	22312EXK	390000	330000	3,600	4,500	4	8	4	72.0	118.0	2.0	0.36	1.86	2.77	1.82	3.05	22312EX	22312EXK
	130	46	2.1	22312AEX	22312AEXK	340000	275000	5,400	6,900	4	8	4	72.0	118.0	2.0	0.41	1.65	2.46	1.62	3.01	22312AEX	22312AEXK
65	120	31	1.5	22213EX	22213EXK	246000	209000	4,300	5,300	3	6	4	73.5	111.5	1.5	0.25	2.69	4.00	2.63	1.56	22213EX	22213EXK
	120	31	1.5	22213AEX	22213AEXK	213000	169000	5,700	7,200	3	6	4	73.5	111.5	1.5	0.30	2.26	3.36	2.21	1.60	22213AEX	22213AEXK
	140	33	2.1	21313EX1	21313EX1K	270000	232000	3,600	4,500	3	6	4	77.0	128.0	2.0	0.24	2.83	4.21	2.76	2.60	21313EX1	21313EX1K
	140	33	2.1	21313AX	21313AXK	261000	222000	5,100	6,400	3	6	4	77.0	128.0	2.0	0.28	2.40	3.57	2.35	2.69	21313AX	21313AXK
	140	48	2.1	22313EX	22313EXK	415000	355000	3,200	4,000	4	8	4	77.0	128.0	2.0	0.34	1.98	2.94	1.93	3.67	22313EX	22313EXK
	140	48	2.1	22313AEX	22313AEXK	380000	310000	4,950	6,450	4	8	4	77.0	128.0	2.0	0.39	1.72	2.55	1.68	3.64	22313AEX	22313AEXK
70	125	31	1.5	22214EX	22214EXK	257000	220000	4,000	5,300	3	6	4	78.5	116.5	1.5	0.24	2.87	4.27	2.80	1.65	22214EX	22214EXK
	125	31	1.5	22214AEX	22214AEXK	225000	185000	5,400	6,900	3	6	4	78.5	116.5	1.5	0.28	2.39	3.55	2.33	1.69	22214AEX	22214AEXK
	150	35	2.1	21314EX1	21314EX1K	310000	260000	3,200	4,000	3	6	4	82.0	138.0	2.0	0.24	2.84	4.23	2.78	3.10	21314EX1	21314EX1K
	150	35	2.1	21314AX	21314AXK	305000	268000	4,500	6,000	3	6	4	82.0	138.0	2.0	0.28	2.45	3.64	2.39	3.30	21314AX	21314AXK
	150	51	2.1	22314EX	22314EXK	480000	415000	3,000	3,800	5	10	4	82.0	138.0	2.0	0.34	1.98	2.94	1.93	4.45	22314EX	22314EXK
	150	51	2.1	22314AEX	22314AEXK	445000	365000	4,650	6,000	5	10	4	82.0	138.0	2.0	0.40	1.71	2.54	1.67	4.46	22314AEX	22314AEXK
75	130	31	1.5	22215EX	22215EXK	265000	234000	4,000	5,000	3	6	4	83.5	121.5	1.5	0.22	3.07	4.58	3.01	1.74	22215EX	22215EXK
	130	31	1.5	22215AEX	22215AEXK	234000	191000	5,100	6,600	3	6	4	83.5	121.5	1.5	0.27	2.51	3.73	2.46	1.76	22215AEX	22215AEXK
	160	37	2.1	21315EX1	21315EX1K	340000	298000	3,200	4,000	3	6	4	87.0	148.0	2.0	0.23	2.87	4.27	2.80	3.80	21315EX1	21315EX1K
	160	37	2.1	21315AX	21315AXK	325000	286000	4,350	5,550	3	6	4	87.0	148.0	2.0	0.27	2.50	3.72	2.44	3.95	21315AX	21315AXK
	160	55	2.1	22315EX	22315EXK	550000	475000	2,800	3,600	5	10	4	87.0	148.0	2.0	0.35	1.95	2.90	1.91	5.44	22315EX	22315EXK
	160	55	2.1	22315AEX	22315AEXK	495000	415000	4,350	5,500	5	10	4	87.0	148.0	2.0	0.39	1.72	2.56	1.68	5.44	22315AEX	22315AEXK

Note: Suffix K or K30 means tapered bore (1/12 or 1/30).

Spherical Roller Bearings

Bore Diameter: 80~95mm

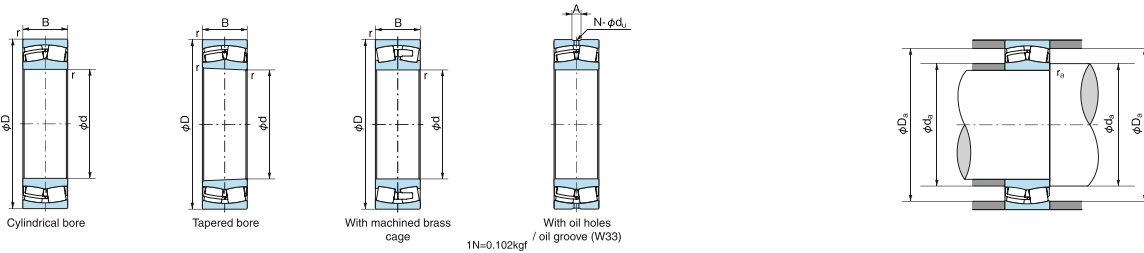

Dynamic equivalent radial load
 $F_r = XFr + YFa$

$\frac{F_r}{Fr} \leq e$		$\frac{F_r}{Fr} > e$	
X	Y	X	Y
1	Y ₁	0.67	Y ₂

Values of Y₁, Y₂ and e from table.

Static equivalent radial load
 $P_0 = Fr + Y_0 Fa$

Values Y₀ from table.

Boundary dimensions (mm)				Bearing No.		Basic dynamic load rating Cr (N)	Basic static load rating Cor (N)	Limiting speed (min ⁻¹)		Dimensions of lubrication holes and grooves			Abutment and fillet dimensions (mm)			Constant e	Axial load factor			Mass (kg) Cylindrical bore (Reference)	Bearing No.	
d	D	B	r (min)	Cylindrical bore	Tapered bore			Grease lubrication	Oil lubrication	Hole diameter φs	Groove width A	Hole count N	da (min)	Da (max)	ra (max)		Y ₁	Y ₂	Y ₀		Cylindrical bore	Tapered bore
80	140	33	2	22216EX	22216EXK	299000	269000	3,600	4,500	3	6	4	90.0	130.0	2.0	0.22	3.07	4.58	3.01	2.19	22216EX	22216EXK
	140	33	2	22216AEX	22216AEXK	279000	230000	4,800	6,100	3	6	4	90.0	130.0	2.0	0.27	2.51	3.74	2.46	2.24	22216AEX	22216AEXK
	140	44.4	2	23216E	23216EK	335000	335000	3,300	4,350	4	8	4	90.0	130.0	2.0	0.29	2.35	3.50	2.30	2.95	23216E	23216EK
	170	39	2.1	21316EX1	21316EX1K	380000	339000	3,000	3,800	4	8	4	92.0	158.0	2.0	0.23	2.88	4.29	2.82	4.50	21316EX1	21316EX1K
	170	39	2.1	21316AX	21316AXK	355000	318000	4,200	5,250	4	8	4	92.0	158.0	2.0	0.26	2.55	3.80	2.50	4.67	21316AX	21316AXK
	170	58	2.1	22316EX	22316EXK	595000	520000	2,600	3,400	5	10	4	92.0	158.0	2.0	0.35	1.95	2.90	1.91	6.42	22316EX	22316EXK
85	150	36	2	22217EX	22217EXK	355000	320000	3,400	4,300	4	7	4	95.0	140.0	2.0	0.22	3.01	4.48	2.94	2.75	22217EX	22217EXK
	150	36	2	22217AEX	22217AEXK	310000	260000	4,200	5,700	4	7	4	95.0	140.0	2.0	0.27	2.47	3.67	2.41	2.82	22217AEX	22217AEXK
	150	49.2	2	23217E	23217EK	395000	405000	3,150	4,050	4	8	4	95.0	140.0	2.0	0.30	2.24	3.34	2.19	3.78	23217E	23217EK
	180	41	3	21317EX1	21317EX1K	415000	372000	3,000	4,000	4	8	4	99.0	166.0	2.5	0.23	2.89	4.30	2.83	5.30	21317EX1	21317EX1K
	180	41	3	21317AX	21317AXK	400000	364000	3,900	5,100	4	8	4	99.0	166.0	2.5	0.26	2.55	3.79	2.49	5.52	21317AX	21317AXK
	180	60	3	22317EX	22317EXK	665000	585000	2,400	3,200	6	11	4	99.0	166.0	2.5	0.33	2.02	3.00	1.97	7.46	22317EX	22317EXK
90	160	40	2	22218EX	22218EXK	410000	375000	3,200	4,000	4	7	4	100.0	150.0	2.0	0.24	2.79	4.15	2.73	3.50	22218EX	22218EXK
	160	40	2	22218AEX	22218AEXK	360000	310000	4,000	5,400	4	7	4	100.0	150.0	2.0	0.28	2.42	3.60	2.36	3.56	22218AEX	22218AEXK
	160	52.4	2	23218EX1	23218EX1K	470000	482000	3,100	4,200	5	10	4	100.0	150.0	2.0	0.32	2.14	3.19	2.09	4.57	23218EX1	23218EX1K
	190	43	3	21318EX1	21318EX1K	460000	410000	2,800	3,600	4	8	6	104.0	176.0	2.5	0.23	2.91	4.33	2.84	6.10	21318EX1	21318EX1K
	190	43	3	21318AX	21318AXK	460000	416000	3,700	4,800	4	8	6	104.0	176.0	2.5	0.26	2.55	3.80	2.50	6.45	21318AX	21318AXK
	190	64	3	22318EX	22318EXK	745000	660000	2,400	3,000	6	11	6	104.0	176.0	2.5	0.34	2.00	2.98	1.96	8.82	22318EX	22318EXK
95	170	43	2.1	22219EX	22219EXK	465000	420000	3,000	3,800	5	8	4	107.0	158.0	2.0	0.24	2.76	4.11	2.70	4.24	22219EX	22219EXK
	170	43	2.1	22219AEX	22219AEXK	410000	360000	3,900	5,100	5	8	4	107.0	158.0	2.0	0.28	2.38	3.55	2.33	4.35	22219AEX	22219AEXK
	170	55.6	2.1	23219E	23219EK	500000	510000	2,800	3,600	5	10	4	107.0	158.0	2.0	0.30	2.24	3.34	2.19	5.46	23219E	23219EK
	200	45	3	21319EX1	21319EX1K	500000	461000	2,700	3,400	4	8	6	109.0	186.0	2.5	0.23	2.92	4.35	2.86	7.10	21319EX1	21319EX1K
	200	45	3	21319AX	21319AXK	495000	450000	3,400	4,500	4	8	6	109.0	186.0	2.5	0.27	2.54	3.79	2.49	7.44	21319AX	21319AXK
	200	67	3	22319EX	22319EXK	815000	725000	2,200	2,900	6	12	6	109.0	186.0	2.5	0.33	2.02	3.00	1.97	10.2	22319EX	22319EXK
200	67	3	22319AEX	22319AEXK	755000	645000	3,450	4,500	6	12	6	109.0	186.0	2.5	0.39	1.74	2.59	1.70	10.3	22319AEX	22319AEXK	

Note: Suffix K or K30 means tapered bore (1/12 or 1/30).

Spherical Roller Bearings

Bore Diameter: 100~110mm

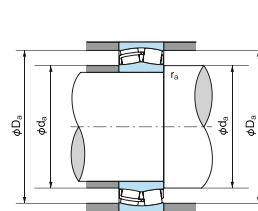
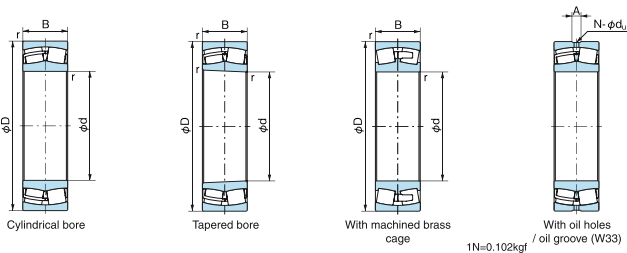

Dynamic equivalent radial load

$F_r = XFr + YFa$

$\frac{F_a}{Fr} \leq e$		$\frac{F_a}{Fr} > e$	
X	Y	X	Y
1	Y ₁	0.67	Y ₂

Values of Y₁, Y₂ and e from table.

Static equivalent radial load

$P_0 = Fr + Y_0 Fa$

Values Y₀ from table.

Boundary dimensions (mm)				Bearing No.		Basic dynamic load rating Cr (N)	Basic static load rating Cor (N)	Limiting speed (min ⁻¹)		Dimensions of lubrication holes and grooves			Abutment and fillet dimensions (mm)			Constant e	Axial load factor			Mass (kg) Cylindrical bore (Reference)	Bearing No.		
d	D	B	r (min)	Cylindrical bore	Tapered bore			Grease lubrication	Oil lubrication	Hole diameter φ _h	Groove width A	Hole count N	d _a (min)	D _a (max)	r _a (max)		Y ₁	Y ₂	Y ₀		Cylindrical bore	Tapered bore	
100	140	30	1.1	23920E	23920EK	197000	233000	3,400	4,500		3	8	4	107.0	133.0	1.0	0.20	3.42	5.08	3.34	1.46	23920E	23920EK
	150	37	1.5	23020E	23020EK	286000	325000	2,700	3,700		4	7	4	117.0	141.0	1.5	0.22	3.01	4.48	2.94	2.33	23020E	23020EK
	150	37	1.5	23020AX	23020AXK	267000	298000	4,200	5,400		4	7	4	117.0	141.0	1.5	0.26	2.64	3.93	2.58	2.40	23020AX	23020AXK
	165	52	2	23120EX1	23120EX1K	450000	500000	2,500	3,300		5	9	4	110.0	155.0	2.0	0.29	2.33	3.47	2.28	4.49	23120EX1	23120EX1K
	165	52	2	23120AX	23120AXK	450000	538000	3,300	4,500		5	9	4	110.0	155.0	2.0	0.34	1.98	2.94	1.93	4.70	23120AX	23120AXK
	180	46	2.1	22220EX	22220EXK	520000	480000	2,800	3,600		5	8	4	112.0	168.0	2.0	0.25	2.74	4.08	2.68	5.10	22220EX	22220EXK
	180	46	2.1	22220AEX	22220AEXK	465000	410000	3,700	4,800		5	8	4	112.0	168.0	2.0	0.29	2.37	3.52	2.31	5.24	22220AEX	22220AEXK
	180	60.3	2.1	23220EX1	23220EX1K	595000	629000	2,800	3,750		5	10	4	112.0	168.0	2.0	0.32	2.09	3.11	2.04	6.76	23220EX1	23220EX1K
	180	60.3	2.1	23220AX	23220AXK	575000	599000	3,100	4,200		5	10	4	112.0	168.0	2.0	0.36	1.88	2.80	1.84	6.88	23220AX	23220AXK
	215	47	3	21320EX1	21320EX1K	580000	524000	2,400	3,300		4	8	6	114.0	201.0	2.5	0.22	3.02	4.49	2.95	8.70	21320EX1	21320EX1K
110	170	45	2	23022E	23022EK	415000	475000	2,700	3,600		5	9	4	120.0	160.0	2.0	0.24	2.84	4.23	2.78	3.84	23022E	23022EK
	170	45	2	23022AX	23022AXK	415000	478000	3,750	4,800		5	9	4	120.0	160.0	2.0	0.28	2.42	3.61	2.37	3.90	23022AX	23022AXK
	180	56	2	23122EX1	23122EX1K	540000	610000	2,700	3,600		5	9	4	120.0	170.0	2.0	0.29	2.36	3.51	2.31	5.70	23122EX1	23122EX1K
	180	56	2	23122AX	23122AXK	535000	605000	3,000	4,050		5	9	4	120.0	170.0	2.0	0.33	2.04	3.03	1.99	5.80	23122AX	23122AXK
	180	69	2	24122EX1	24122EX1K30	633000	743000	2,700	3,600		6	11	4	120.0	170.0	2.0	0.37	1.84	2.74	1.80	6.89	24122EX1	24122EX1K30
	180	69	2	24122AX	24122AXK30	620000	654000	2,700	3,600		6	11	4	120.0	170.0	2.0	0.37	1.80	2.69	1.76	6.85	24122AX	24122AXK30
	200	53	2.1	22222EX	22222EXK	680000	640000	2,600	3,200		5	10	6	122.0	188.0	2.0	0.26	2.64	3.93	2.58	7.36	22222EX	22222EXK
	200	53	2.1	22222AEX	22222AEXK	605000	550000	3,300	4,350		6	10	6	122.0	188.0	2.0	0.29	2.31	3.44	2.26	7.53	22222AEX	22222AEXK
	200	69.8	2.1	23222EX1	23222EX1K	750000	793000	2,550	3,300		6	11	6	122.0	188.0	2.0	0.34	1.99	2.96	1.94	9.60	23222EX1	23222EX1K
	200	69.8	2.1	23222AX	23222AXK	740000	801000	2,850	3,750		6	11	6	122.0	188.0	2.0	0.38	1.78	2.65	1.74	10.0	23222AX	23222AXK
240	50	3	21322EX1	21322EX1K	675000	635000	2,100	2,850		4	8	6	124.0	226.0	2.5	0.21	3.19	4.75	3.12	11.6	21322EX1	21322EX1K	
240	50	3	21322AX	21322AXK	655000	601000	3,000	3,750		4	8	6	124.0	226.0	2.5	0.24	2.78	4.14	2.72	12.2	21322AX	21322AXK	
240	80	3	22322EX	22322EXK	1150000	1040000	1,950	2,700		6	12	6	124.0	226.0	2.5	0.33	2.03	3.02	1.98	18.1	22322EX	22322EXK	
240	80	3	22322AEX	22322AEXK	1030000	940000	3,000	3,750		6	12	6	124.0	226.0	2.5	0.38	1.77	2.63	1.73	18.2	22322AEX	22322AEXK	

Note: Suffix K or K30 means tapered bore (1/12 or 1/30).

Spherical Roller Bearings

Bore Diameter: 120~130mm

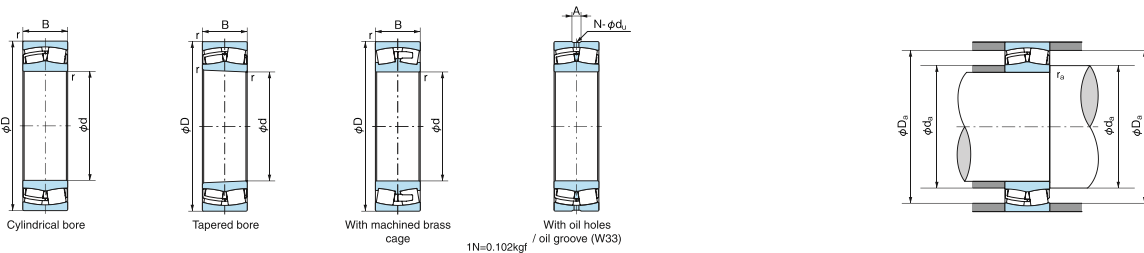

Dynamic equivalent radial load
 $F_r = XFr + YFa$

$\frac{F_r}{Fr} \leq e$		$\frac{F_r}{Fr} > e$	
X	Y	X	Y
1	Y ₁	0.67	Y ₂

Values of Y₁, Y₂ and e from table.

Static equivalent radial load
 $P_0 = Fr + Y_0 Fa$

Values Y₀ from table.

Boundary dimensions (mm)				Bearing No.		Basic dynamic load rating Cr (N)	Basic static load rating Cor (N)	Limiting speed (min ⁻¹)		Dimensions of lubrication holes and grooves			Abutment and fillet dimensions (mm)			Constant e	Axial load factor			Mass (kg) Cylindrical bore (Reference)	Bearing No.	
d	D	B	r (min)	Cylindrical bore	Tapered bore			Grease lubrication	Oil lubrication	Hole diameter φ _h	Groove width A	Hole count N	d _a (min)	D _a (max)	r _a (max)		Y ₁	Y ₂	Y ₀		Cylindrical bore	Tapered bore
120	180	46	2	23024E	23024EK	430000	515000	2,550	3,300	5	9	4	130.0	170.0	2.0	0.23	2.95	4.39	2.89	4.20	23024E	23024EK
	180	46	2	23024AX	23024AXK	430000	516000	3,450	4,500	5	9	4	130.0	170.0	2.0	0.27	2.52	3.76	2.47	4.20	23024AX	23024AXK
	180	60	2	24024EX1	24024EX1K30	540000	683000	2,550	3,450	5	9	4	130.0	170.0	2.0	0.30	2.23	3.32	2.18	5.36	24024EX1	24024EX1K30
	180	60	2	24024AX	24024AXK30	540000	627000	2,550	3,450	5	9	4	130.0	170.0	2.0	0.31	2.21	3.29	2.16	5.26	24024AX	24024AXK30
	200	62	2	23124EX1	23124EX1K	675000	720000	2,400	3,300	5	9	6	130.0	190.0	2.0	0.29	2.34	3.49	2.29	7.90	23124EX1	23124EX1K
	200	62	2	23124AX	23124AXK	645000	734000	2,700	3,600	5	9	6	130.0	190.0	2.0	0.34	2.00	2.99	1.96	8.10	23124AX	23124AXK
	200	80	2	24124EX1	24124EX1K30	815000	970000	2,400	3,300	6	11	6	130.0	190.0	2.0	0.38	1.78	2.65	1.74	10.1	24124EX1	24124EX1K30
	200	80	2	24124AX	24124AXK30	780000	850000	2,400	3,300	6	11	6	130.0	190.0	2.0	0.39	1.73	2.58	1.69	9.90	24124AX	24124AXK30
	215	58	2.1	22224EX	22224EXK	785000	765000	2,400	3,000	5	10	6	132.0	203.0	2.0	0.26	2.60	3.87	2.54	9.28	22224EX	22224EXK
	215	58	2.1	22224AEX	22224AEXK	700000	650000	3,150	4,050	5	10	6	132.0	203.0	2.0	0.30	2.28	3.40	2.23	9.35	22224AEX	22224AEXK
	215	76	2.1	23224EX1	23224EX1K	860000	956000	2,250	3,150	6	13	6	132.0	203.0	2.0	0.34	1.97	2.94	1.93	12.0	23224EX1	23224EX1K
	215	76	2.1	23224AX	23224AXK	860000	962000	2,550	3,450	6	13	6	132.0	203.0	2.0	0.39	1.73	2.57	1.69	12.3	23224AX	23224AXK
130	260	55	3	21324E	21324EK	790000	765000	1,950	2,400	5	12	6	134.0	246.0	2.5	0.21	3.17	4.72	3.10	15.3	21324E	21324EK
	260	86	3	22324EX	22324EXK	1250000	1130000	1,800	2,600	8	14	6	134.0	246.0	2.5	0.33	2.03	3.02	1.98	22.6	22324EX	22324EXK
	260	86	3	22324AEX	22324AEXK	1180000	1040000	2,700	3,450	8	14	6	134.0	246.0	2.5	0.38	1.77	2.64	1.73	22.2	22324AEX	22324AEXK
	180	37	1.5	23926E	23926EK	284000	355000	2,700	3,450	4	8	4	138.5	171.5	1.5	0.18	3.66	5.46	3.58	2.87	23926E	23926EK
	200	52	2	23026E	23026EK	555000	660000	2,400	3,000	5	10	6	140.0	190.0	2.0	0.24	2.87	4.27	2.80	6.14	23026E	23026EK
	200	52	2	23026AX	23026AXK	560000	664000	3,150	4,050	5	10	6	140.0	190.0	2.0	0.27	2.50	3.72	2.44	6.10	23026AX	23026AXK
	200	69	2	24026EX1	24026EX1K30	710000	900000	2,400	3,150	6	11	6	140.0	190.0	2.0	0.32	2.14	3.18	2.09	7.93	24026EX1	24026EX1K30
	200	69	2	24026AX	24026AXK30	680000	803000	2,400	3,150	6	11	6	140.0	190.0	2.0	0.33	2.04	3.04	2.00	7.77	24026AX	24026AXK30
	210	64	2	23126EX1	23126EX1K	690000	799000	2,200	3,000	5	9	6	140.0	200.0	2.0	0.28	2.42	3.61	2.37	8.60	23126EX1	23126EX1K
	210	64	2	23126AX	23126AXK	827000	2,500	3,300	5	9	6	140.0	200.0	2.0	0.30	2.25	3.34	2.20	8.90	23126AX	23126AXK	
	210	80	2	24126EX1	24126EX1K30	840000	1030000	2,200	3,000	6	11	6	140.0	200.0	2.0	0.36	1.90	2.83	1.86	10.7	24126EX1	24126EX1K30
	210	80	2	24126AX	24126AXK30	815000	918000	2,200	3,000	6	11	6	140.0	200.0	2.0	0.37	1.83	2.72	1.79	10.5	24126AX	24126AXK30
230	64	3	22226EX	22226EXK	910000	915000	2,200	2,600	5	10	6	144.0	216.0	2.5	0.26	2.55	3.80	2.50	11.6	22226EX	22226EXK	
230	64	3	22226AEX	22226AEXK	815000	765000	2,800	3,700	5	10	6	144.0	216.0	2.5	0.30	2.22	3.30	2.17	11.6	22226AEX	22226AEXK	
230	80	3	23226EX1	23226EX1K	980000	1090000	2,100	2,800	6	13	6	144.0	216.0	2.5	0.33	2.05	3.05	2.00	14.2	23226EX1	23226EX1K	
230	80	3	23226AX	23226AXK	965000	1070000	2,400	3,100	6	13	6	144.0	216.0	2.5	0.38	1.78	2.65	1.74	14.5	23226AX	23226AXK	
280	93	4	22326EX	22326EXK	1450000	1340000	1,700	2,500	8	16	6	148.0	262.0	3.0	0.33	2.03	3.02	1.98	28.4	22326EX	22326EXK	
280	93	4	22326AEX	22326AEXK	1370000	1220000	2,500	3,300	8	16	6	148.0	262.0	3.0	0.38	1.77	2.64	1.73	27.3	22326AEX	22326AEXK	

Note: Suffix K or K30 means tapered bore (1/12 or 1/30).

Spherical Roller Bearings

Bore Diameter: 140~150mm

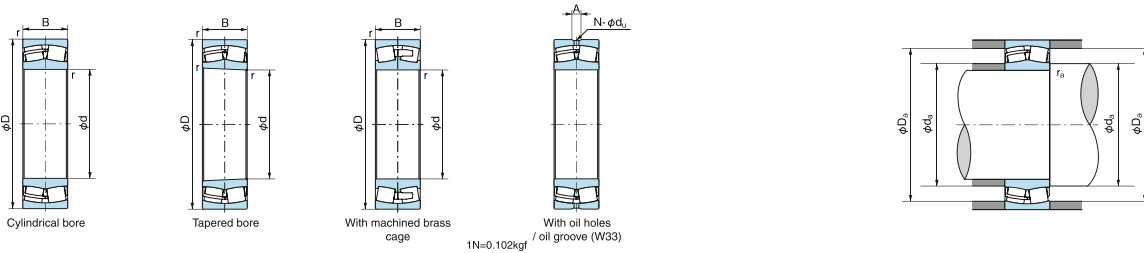

Dynamic equivalent radial load
 $F_r = \sqrt[3]{X F_r + Y F_a}$

$\frac{F_a}{F_r} \leq e$		$\frac{F_a}{F_r} > e$	
X	Y	X	Y
1	Y ₁	0.67	Y ₂

Values of Y₁, Y₂ and e from table.

Static equivalent radial load
 $F_{0r} = F_r + Y_0 F_a$

Values Y₀ from table.

Boundary dimensions (mm)				Bearing No.		Basic dynamic load rating Cr (N)	Basic static load rating Cor (N)	Limiting speed (min ⁻¹)		Dimensions of lubrication holes and grooves			Abutment and fillet dimensions (mm)			Constant e	Axial load factor			Mass (kg) Cylindrical bore (Reference)	Bearing No.	
d	D	B	r (min)	Cylindrical bore	Tapered bore			Grease lubrication	Oil lubrication	Hole diameter φ _h	Groove width A	Hole count N	d _a (min)	D _a (max)	r _a (max)		Y ₁	Y ₂	Y ₀		Cylindrical bore	Tapered bore
140	190	37	1.5	23928AX	23928AXK	345000	466000	2,550	3,300	4	7	6	148.5	181.5	1.5	0.18	3.79	5.65	3.71	3.13	23928AX	23928AXK
	210	53	2	23028E	23028EK	585000	710000	2,400	2,800	5	10	6	150.0	200.0	2.0	0.23	2.98	4.44	2.91	6.61	23028E	23028EK
	210	53	2	23028AX	23028AXK	580000	711000	3,000	3,900	5	10	6	150.0	200.0	2.0	0.25	2.75	4.10	2.69	6.70	23028AX	23028AXK
	210	69	2	24028EX1	24028EX1K30	720000	920000	2,200	3,000	6	11	6	150.0	200.0	2.0	0.30	2.28	3.39	2.23	8.40	24028EX1	24028EX1K30
	210	69	2	24028AX	24028AXK30	720000	819000	2,200	3,000	6	11	6	150.0	200.0	2.0	0.31	2.15	3.20	2.10	8.22	24028AX	24028AXK30
	225	68	2.1	23128EX1	23128EX1K	790000	940000	2,100	2,850	6	11	6	152.0	213.0	2.0	0.28	2.45	3.65	2.40	10.5	23128EX1	23128EX1K
	225	68	2.1	23128AX	23128AXK	790000	934000	2,200	3,100	6	11	6	152.0	213.0	2.0	0.30	2.27	3.37	2.22	10.8	23128AX	23128AXK
	225	85	2.1	24128EX1	24128EX1K30	950000	1180000	2,100	2,800	8	14	6	152.0	213.0	2.0	0.36	1.87	2.79	1.83	13.0	24128EX1	24128EX1K30
	225	85	2.1	24128AX	24128AXK30	930000	1030000	2,100	2,800	8	14	6	152.0	213.0	2.0	0.36	1.87	2.79	1.83	12.7	24128AX	24128AXK30
	250	68	3	22228EX	22228EXK	1050000	1030000	1,900	2,500	6	12	6	154.0	236.0	2.5	0.26	2.60	3.87	2.54	13.9	22228EX	22228EXK
	250	68	3	22228AEX	22228AEXK	945000	890000	2,700	3,400	6	12	6	154.0	236.0	2.5	0.30	2.26	3.37	2.21	14.8	22228AEX	22228AEXK
	250	88	3	23228EX1	23228EX1K	1130000	1290000	1,900	2,500	8	15	6	154.0	236.0	2.5	0.34	1.99	2.96	1.95	18.8	23228EX1	23228EX1K
250	88	3	23228AX	23228AXK	1120000	1270000	2,200	2,800	8	16	6	154.0	236.0	2.5	0.38	1.78	2.65	1.74	19.3	23228AX	23228AXK	
150	300	102	4	22328E	22328EK	1540000	1520000	1,600	2,200	10	22	6	158.0	282.0	3.0	0.37	1.82	2.72	1.78	35.9	22328E	22328EK
	300	102	4	22328A2X	22328A2XK	1560000	1540000	2,200	3,000	10	22	6	158.0	282.0	3.0	0.40	1.69	2.52	1.65	34.5	22328A2X	22328A2XK
	210	45	2	23930AX	23930AXK	465000	622000	2,400	3,000	5	9	6	200.0	160.0	2.0	0.20	3.44	5.12	3.36	5.01	23930AX	23930AXK
	225	56	2.1	23030E	23030EK	640000	790000	1,900	2,500	5	11	6	162.0	213.0	2.0	0.22	3.04	4.53	2.97	8.01	23030E	23030EK
	225	56	2.1	23030AX	23030AXK	640000	791000	2,700	3,600	5	11	6	162.0	213.0	2.0	0.24	2.79	4.16	2.73	8.20	23030AX	23030AXK
	225	75	2.1	24030EX1	24030EX1K30	815000	1060000	2,100	2,700	6	11	6	162.0	213.0	2.0	0.30	2.23	3.32	2.18	10.5	24030EX1	24030EX1K30
	225	75	2.1	24030AX	24030AXK30	815000	924000	2,100	2,700	6	11	6	162.0	213.0	2.0	0.32	2.10	3.13	2.06	10.4	24030AX	24030AXK30
	250	80	2.1	23130EX1	23130EX1K	1000000	1230000	1,900	2,500	6	13	6	162.0	238.0	2.0	0.30	2.24	3.34	2.19	16.2	23130EX1	23130EX1K
	250	80	2.1	23130AX	23130AXK	1030000	1310000	2,100	2,800	6	13	6	162.0	238.0	2.0	0.35	1.95	2.91	1.91	16.7	23130AX	23130AXK
	250	100	2.1	24130EX1	24130EX1K30	1230000	1520000	1,900	2,500	8	14	6	162.0	238.0	2.0	0.38	1.77	2.64	1.73	19.6	24130EX1	24130EX1K30
	250	100	2.1	24130AX	24130AXK30	1120000	1340000	1,900	2,500	8	14	6	162.0	238.0	2.0	0.38	1.76	2.62	1.72	19.5	24130AX	24130AXK30
	270	73	3	22230EX	22230EXK	1200000	1200000	1,800	2,400	6	14	6	164.0	256.0	2.5	0.25	2.69	4.00	2.63	18.9	22230EX	22230EXK
270	73	3	22230AEX	22230AEXK	1060000	1020000	2,400	3,100	6	14	6	164.0	256.0	2.5	0.29	2.30	3.42	2.25	18.1	22230AEX	22230AEXK	
270	96	3	23230EX1	23230EX1K	1340000	1540000	1,800	2,400	8	15	6	164.0	256.0	2.5	0.34	1.96	2.93	1.92	24.2	23230EX1	23230EX1K	
270	96	3	23230AX	23230AXK	1320000	1530000	1,900	2,700	8	15	6	164.0	256.0	2.5	0.40	1.70	2.53	1.66	24.8	23230AX	23230AXK	
320	108	4	22330E	22330EK	1770000	1740000	1,500	2,100	10	22	6	168.0	302.0	3.0	0.37	1.82	2.70	1.78	43.3	22330E	22330EK	
320	108	4	22330A2X	22330A2XK	1720000	1710000	2,100	2,800	10	22	6	168.0	302.0	3.0	0.40	1.67	2.49	1.63	41.5	22330A2X	22330A2XK	

Note: Suffix K or K30 means tapered bore (1/12 or 1/30).

Spherical Roller Bearings

Bore Diameter: 160~170mm

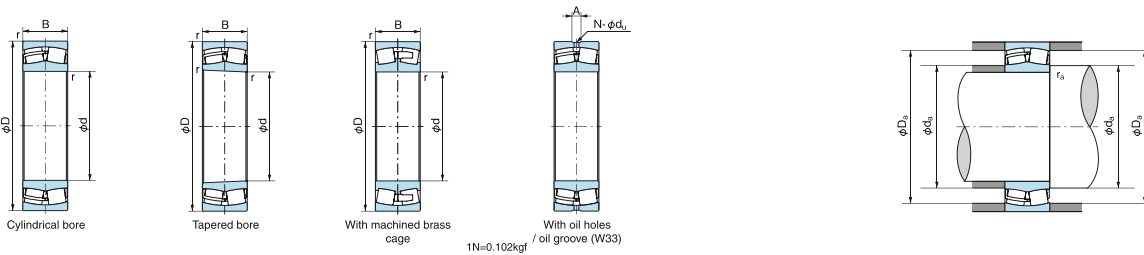

■ Dynamic equivalent radial load
Fr = XFr + YFa

Fr ≤ e		Fr > e	
X	Y	X	Y
1	Y ₁	0.67	Y ₂

Values of Y₁, Y₂ and e from table.

■ Static equivalent radial load
P_{0r} = Fr + Y₀Fa

Values Y₀ from table.

Boundary dimensions (mm)			Bearing No.		Basic dynamic load rating Cr (N)	Basic static load rating Cor (N)	Limiting speed (min ⁻¹)		Dimensions of lubrication holes and grooves			Abutment and fillet dimensions (mm)			Constant e	Axial load factor			Mass (kg) Cylindrical bore (Reference)	Bearing No.			
d	D	B	r (min)	Cylindrical bore			Tapered bore	Grease lubrication	Oil lubrication	Hole diameter φ _h	Groove width A	Hole count N	d _a (min)	D _a (max)		r _a (max)	Y ₁	Y ₂		Y ₀	Cylindrical bore	Tapered bore	
160	220	45	2	23932AX	23932AXK	475000	649000	2,250	2,800		5	10	6	170.0	210.0	2.0	0.19	3.60	5.37	3.52	5.29	23932AX	23932AXK
	240	60	2.1	23032E	23032EK	735000	915000	1,800	2,400		5	11	6	172.0	228.0	2.0	0.22	3.01	4.48	2.94	9.74	23032E	23032EK
	240	60	2.1	23032AX	23032AXK	735000	917000	2,500	3,300		5	11	6	172.0	228.0	2.0	0.24	2.79	4.16	2.73	9.90	23032AX	23032AXK
	240	80	2.1	24032EX1	24032EX1K30	950000	1280000	1,900	2,500		6	11	6	172.0	228.0	2.0	0.30	2.24	3.34	2.19	12.7	24032EX1	24032EX1K30
	240	80	2.1	24032AX	24032AXK30	915000	1110000	1,900	2,500		6	11	6	172.0	228.0	2.0	0.32	2.12	3.15	2.07	12.4	24032AX	24032AXK30
	270	86	2.1	23132EX1	23132EX1K	1180000	1430000	1,800	2,400		8	16	6	172.0	258.0	2.0	0.30	2.22	3.30	2.17	20.5	23132EX1	23132EX1K
	270	86	2.1	23132AX	23132AXK	1200000	1460000	1,900	2,500		8	16	6	172.0	258.0	2.0	0.34	1.96	2.91	1.91	21.2	23132AX	23132AXK
	270	109	2.1	24132EX1	24132EX1K30	1450000	1810000	1,800	2,400		10	17	6	172.0	258.0	2.0	0.39	1.74	2.59	1.70	25.5	24132EX1	24132EX1K30
	270	109	2.1	24132AX	24132AXK30	1340000	1610000	1,800	2,400		10	17	6	172.0	258.0	2.0	0.39	1.74	2.59	1.70	25.5	24132AX	24132AXK30
	290	80	3	22232E	22232EK	1230000	1330000	1,500	2,100		6	14	6	174.0	276.0	2.5	0.26	2.57	3.83	2.52	23.7	22232E	22232EK
	290	80	3	22232E2	22232E2K	1230000	1320000	1,800	2,400		6	14	6	174.0	276.0	2.5	0.28	2.37	3.53	2.32	24.0	22232E2	22232E2K
	290	80	3	22232A2X	22232A2XK	1210000	1300000	2,200	3,000		6	14	6	174.0	276.0	2.5	0.31	2.20	3.27	2.15	23.8	22232A2X	22232A2XK
	290	104	3	23232E	23232EK	1500000	1710000	1,300	1,800		10	22	6	174.0	276.0	2.5	0.37	1.82	2.71	1.78	30.4	23232E	23232EK
	290	104	3	23232A2X	23232A2XK	1460000	1650000	1,900	2,400		10	22	6	174.0	276.0	2.5	0.39	1.72	2.56	1.68	30.7	23232A2X	23232A2XK
340	114	4	22332E	22332EK	1950000	1950000	1,400	1,900		10	22	6	178.0	322.0	3.0	0.36	1.85	2.75	1.81	51.4	22332E	22332EK	
170	230	45	2	23934AX	23934AXK	490000	691000	2,100	2,700		5	10	6	180.0	220.0	2.0	0.18	3.78	5.63	3.70	5.58	23934AX	23934AXK
	260	67	2.1	23034E	23034EK	880000	1080000	1,600	2,200		6	13	6	182.0	248.0	2.0	0.23	2.89	4.31	2.83	13.1	23034E	23034EK
	260	67	2.1	23034AX	23034AXK	880000	1080000	2,400	3,100		6	13	6	182.0	248.0	2.0	0.27	2.51	3.74	2.45	13.1	23034AX	23034AXK
	260	90	2.1	24034EX1	24034EX1K30	1120000	1480000	1,800	2,400		8	14	6	182.0	248.0	2.0	0.32	2.11	3.15	2.07	17.3	24034EX1	24034EX1K30
	260	90	2.1	24034AX	24034AXK30	1030000	1320000	1,800	2,400		8	14	6	182.0	248.0	2.0	0.34	2.00	2.97	1.95	17.0	24034AX	24034AXK30
	280	88	2.1	23134EX1	23134EX1K	1260000	1530000	1,600	2,200		8	16	6	182.0	268.0	2.0	0.29	2.30	3.43	2.25	21.6	23134EX1	23134EX1K
	280	88	2.1	23134AX	23134AXK	1260000	1500000	1,800	2,400		8	16	6	182.0	268.0	2.0	0.34	2.01	3.00	1.97	22.2	23134AX	23134AXK
	280	109	2.1	24134AX	24134AXK30	1360000	1650000	1,600	2,200		10	17	6	182.0	268.0	2.0	0.37	1.82	2.70	1.78	26.4	24134AX	24134AXK30
	310	86	4	22234E	22234EK	1390000	1510000	1,400	1,900		8	18	6	188.0	292.0	3.0	0.29	2.33	3.47	2.28	30.0	22234E	22234EK
	310	110	4	23234E	23234EK	1720000	1970000	1,300	1,800		10	22	6	188.0	292.0	3.0	0.36	1.85	2.75	1.81	37.0	23234E	23234EK
	310	110	4	23234A2X	23234A2XK	1680000	1910000	1,800	2,250		10	22	6	188.0	292.0	3.0	0.39	1.71	2.54	1.67	37.6	23234A2X	23234A2XK
360	120	4	22334E	22334EK	2150000	2200000	1,300	1,800		10	22	6	188.0	342.0	3.0	0.36	1.85	2.75	1.81	60.6	22334E	22334EK	

Note: Suffix K or K30 means tapered bore (1/12 or 1/30).

Spherical Roller Bearings

Bore Diameter: 180~200mm

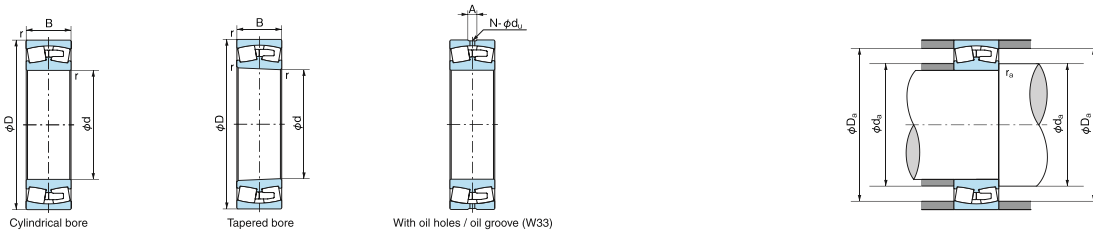

■ Dynamic equivalent radial load
 $F_r = XFr + YFa$

$\frac{F_r}{Fr} \leq e$		$\frac{F_r}{Fr} > e$	
X	Y	X	Y
1	Y ₁	0.67	Y ₂

Values of Y₁, Y₂ and e from table.

■ Static equivalent radial load
 $P_0 = Fr + Y_0 Fa$

Values Y₀ from table.

Boundary dimensions (mm)				Bearing No.		Basic dynamic load rating Cr (N)	Basic static load rating Cor (N)	Limiting speed (min ⁻¹)		Dimensions of lubrication holes and grooves			Abutment and fillet dimensions (mm)			Constant e	Axial load factor			Mass (kg) Cylindrical bore (Reference)	Bearing No.	
d	D	B	r (min)	Cylindrical bore	Tapered bore			Grease lubrication	Oil lubrication	Hole diameter φ _h	Groove width A	Hole count N	d _a (min)	D _a (max)	r _a (max)		Y ₁	Y ₂	Y ₀		Cylindrical bore	Tapered bore
180	250	52	2	23936AX	23936AXK	665000	939000	1,900	2,500	6	10	6	190.0	240.0	2.0	0.19	3.55	5.29	3.48	8.10	23936AX	23936AXK
	280	74	2.1	23036E	23036EK	1070000	1330000	1,500	2,200	8	15	6	192.0	268.0	2.0	0.24	2.84	4.23	2.78	17.4	23036E	23036EK
	280	74	2.1	23036AX	23036AXK	1040000	1280000	2,200	2,800	8	15	6	192.0	268.0	2.0	0.27	2.47	3.67	2.41	17.5	23036AX	23036AXK
	280	100	2.1	24036EX1	24036EX1K30	1330000	1760000	1,600	2,100	8	16	6	192.0	268.0	2.0	0.33	2.04	3.03	1.99	22.7	24036EX1	24036EX1K30
	280	100	2.1	24036AX	24036AXK30	1230000	1580000	1,600	2,100	8	16	6	192.0	268.0	2.0	0.32	2.12	3.15	2.07	22.5	24036AX	24036AXK30
	300	96	3	23136E	23136EK	1490000	1810000	1,300	1,800	8	18	6	194.0	286.0	2.5	0.32	2.12	3.15	2.07	27.9	23136E	23136EK
	300	96	3	23136A2X	23136A2XK	1450000	1740000	1,800	2,200	8	18	6	194.0	286.0	2.5	0.33	2.04	3.04	2.00	28.2	23136A2X	23136A2XK
	300	118	3	24136E	24136EK30	1640000	2040000	1,350	1,800	10	22	6	194.0	286.0	2.5	0.39	1.73	2.57	1.69	33.7	24136E	24136EK30
	320	86	4	22236E	22236EK	1460000	1610000	1,400	1,900	8	18	6	198.0	302.0	3.0	0.28	2.43	3.61	2.37	30.9	22236E	22236EK
	320	112	4	23236E	23236EK	1790000	2100000	1,200	1,600	10	22	6	198.0	302.0	3.0	0.36	1.87	2.79	1.83	39.4	23236E	23236EK
190	320	112	4	23236A2X	23236A2XK	1750000	2070000	1,800	2,200	10	22	6	198.0	302.0	3.0	0.39	1.75	2.61	1.71	39.0	23236A2X	23236A2XK
	380	126	4	22336E	22336EK	2380000	2400000	1,200	1,600	12	26	6	198.0	362.0	3.0	0.36	1.87	2.78	1.83	70.5	22336E	22336EK
	260	52	2	23938AX	23938AXK	675000	969000	1,800	2,400	6	10	6	200.0	250.0	2.0	0.18	3.69	5.50	3.61	8.46	23938AX	23938AXK
	290	75	2.1	23038E	23038EK	1080000	1330000	1,400	1,900	6	14	6	202.0	278.0	2.0	0.25	2.69	4.00	2.63	18.4	23038E	23038EK
	290	75	2.1	23038A2X	23038A2XK	1080000	1310000	2,100	2,800	6	14	6	202.0	278.0	2.0	0.26	2.55	3.80	2.50	17.8	23038A2X	23038A2XK
	290	100	2.1	24038E	24038EK30	1420000	1920000	1,300	1,800	8	18	6	202.0	278.0	2.0	0.34	1.98	2.94	1.93	24.6	24038E	24038EK30
	320	104	3	23138E	23138EK	1720000	2120000	1,200	1,600	10	22	6	204.0	306.0	2.5	0.32	2.09	3.11	2.04	35.0	23138E	23138EK
	320	104	3	23138A2X	23138A2XK	1710000	2090000	1,600	2,100	10	22	6	204.0	306.0	2.5	0.34	1.96	2.92	1.92	33.5	23138A2X	23138A2XK
	320	128	3	24138E	24138EK30	1900000	2380000	1,200	1,600	12	26	6	204.0	306.0	2.5	0.40	1.68	2.50	1.64	42.0	24138E	24138EK30
	340	92	4	22238E	22238EK	1590000	1740000	1,300	1,800	8	18	6	208.0	322.0	3.0	0.28	2.39	3.56	2.34	37.2	22238E	22238EK
200	340	120	4	23238E	23238EK	2070000	2450000	1,200	1,500	10	22	6	208.0	322.0	3.0	0.36	1.87	2.79	1.83	48.0	23238E	23238EK
	340	120	4	23238A2X	23238A2XK	2000000	2370000	1,600	2,100	10	22	6	208.0	322.0	3.0	0.39	1.72	2.56	1.68	47.5	23238A2X	23238A2XK
	400	132	5	22338E	22338EK	2600000	2670000	1,200	1,600	12	26	6	212.0	378.0	4.0	0.36	1.89	2.81	1.85	81.8	22338E	22338EK
	280	60	2.1	23940AX	23940AXK	840000	1190000	1,800	2,200	6	11	6	212.0	268.0	2.0	0.20	3.44	5.13	3.37	11.9	23940AX	23940AXK
	310	82	2.1	23040E	23040EK	1270000	1560000	1,400	1,900	8	18	6	212.0	298.0	2.0	0.26	2.64	3.93	2.58	23.4	23040E	23040EK
	310	82	2.1	23040A2X	23040A2XK	1270000	1570000	1,900	2,500	8	18	6	212.0	298.0	2.0	0.28	2.45	3.64	2.39	23.3	23040A2X	23040A2XK
	310	109	2.1	24040E	24040EK30	1640000	2230000	1,200	1,600	10	22	6	212.0	298.0	2.0	0.35	1.95	2.90	1.91	31.2	24040E	24040EK30
	340	112	3	23140E	23140EK	1950000	2390000	1,200	1,500	10	22	6	214.0	326.0	2.5	0.33	2.06	3.06	2.01	42.7	23140E	23140EK
	340	112	3	23140A2X	23140A2XK	1900000	2330000	1,600	2,100	10	22	6	214.0	326.0	2.5	0.35	1.94	2.83	1.89	42.5	23140A2X	23140A2XK
	340	140	3	24140E	24140EK30	2220000	2820000	1,200	1,500	12	26	6	214.0	326.0	2.5	0.41	1.63	2.43	1.60	52.9	24140E	24140EK30
360	98	4	22240E	22240EK	1810000	1990000	1,200	1,600	8	18	6	218.0	342.0	3.0	0.29	2.35	3.50	2.30	44.8	22240E	22240EK	
360	128	4	23240E	23240EK	2290000	2750000	1,200	1,500	12	26	6	218.0	342.0	3.0	0.37	1.85	2.75	1.80	57.7	23240E	23240EK	
360	128	4	23240A2X	23240A2XK	2240000	2680000	1,500	1,900	12	26	6	218.0	342.0	3.0	0.39	1.71	2.54	1.67	57.0	23240A2X	23240A2XK	
420	138	5	22340E	22340EK	2890000	3000000	1,200	1,500	12	26	6	222.0	398.0	4.0	0.35	1.93	2.87	1.88	93.7	22340E	22340EK	

Note: Suffix K or K30 means tapered bore (1/12 or 1/30).

Spherical Roller Bearings

Bore Diameter: 220~260mm

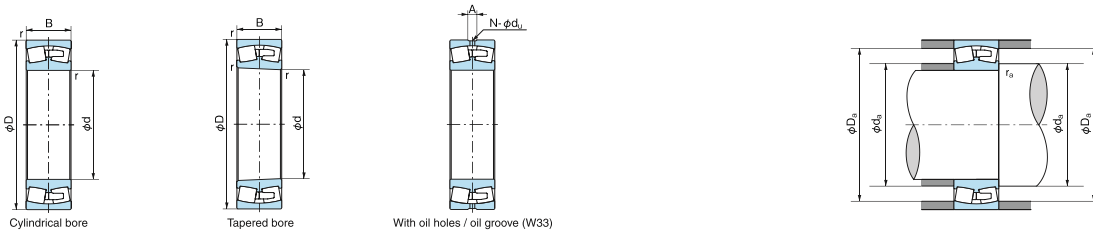

■ Dynamic equivalent radial load

$$F_r = XFr + YFa$$

$\frac{F_a}{F_r} \leq e$		$\frac{F_a}{F_r} > e$	
X	Y	X	Y
1	Y ₁	0.67	Y ₂

Values of Y₁, Y₂ and e from table.

■ Static equivalent radial load

$P_0 = Fr + Y_0 Fa$

Values Y₀ from table.

Boundary dimensions (mm)				Bearing No.		Basic dynamic load rating Cr (N)	Basic static load rating Cor (N)	Limiting speed (min ⁻¹)		Dimensions of lubrication holes and grooves			Abutment and fillet dimensions (mm)			Constant e	Axial load factor			Mass (kg) Cylindrical bore (Reference)	Bearing No.	
d	D	B	r (min)	Cylindrical bore	Tapered bore			Grease lubrication	Oil lubrication	Hole diameter φ _h	Groove width A	Hole count N	d _a (min)	D _a (max)	r _a (max)		Y ₁	Y ₂	Y ₀		Cylindrical bore	Tapered bore
220	300	60	2.1	23944E	23944EK	840000	1190000	1,300	1,800	6	12	6	232.0	288.0	2.0	0.18	3.75	5.59	3.67	12.6	23944E	23944EK
	340	90	3	23044E	23044EK	1470000	1880000	1,200	1,600	8	18	6	234.0	326.0	2.5	0.26	2.64	3.93	2.58	30.7	23044E	23044EK
	340	90	3	23044A2X	23044A2XK	1460000	1860000	1,800	2,400	8	18	6	234.0	326.0	2.5	0.27	2.51	3.74	2.45	30.5	23044A2X	23044A2XK
	340	118	3	24044E	24044EK30	1950000	2670000	1,200	1,500	10	22	6	234.0	326.0	2.5	0.34	1.98	2.95	1.94	40.3	24044E	24044EK30
	370	120	4	23144E	23144EK	2250000	2870000	1,000	1,300	10	22	6	238.0	352.0	3.0	0.33	2.06	3.07	2.02	54.3	23144E	23144EK
	370	120	4	23144A2X	23144A2XK	2210000	2780000	1,500	1,800	10	22	6	238.0	352.0	3.0	0.34	1.98	2.94	1.93	54.6	23144A2X	23144A2XK
	370	150	4	24144E	24144EK30	2530000	3250000	1,100	1,400	12	26	6	238.0	352.0	3.0	0.41	1.66	2.47	1.62	66.3	24144E	24144EK30
	400	108	4	22244E	22244EK	2140000	2380000	1,200	1,500	10	22	6	238.0	382.0	3.0	0.29	2.36	3.52	2.31	61.9	22244E	22244EK
	400	144	4	23244E	23244EK	2920000	3500000	1,000	1,200	12	26	6	238.0	382.0	3.0	0.37	1.83	2.72	1.79	81.4	23244E	23244EK
	460	145	5	22344E	22344EK	3350000	3600000	1,000	1,300	12	26	6	242.0	438.0	4.0	0.34	2.00	2.98	1.95	119	22344E	22344EK
240	320	60	2.1	23948E	23948EK	870000	1260000	1,200	1,600	6	12	6	252.0	308.0	2.0	0.17	3.95	5.87	3.86	13.7	23948E	23948EK
	360	92	3	23048E	23048EK	1530000	2000000	1,200	1,500	8	18	6	254.0	346.0	2.5	0.24	2.76	4.11	2.70	33.5	23048E	23048EK
	360	92	3	23048A2X	23048A2XK	1570000	2090000	1,600	2,200	8	18	6	254.0	346.0	2.5	0.27	2.53	3.77	2.47	33.5	23048A2X	23048A2XK
	360	118	3	24048E	24048EK30	1990000	2800000	1,000	1,300	10	22	6	254.0	346.0	2.5	0.32	2.10	3.13	2.05	43.3	24048E	24048EK30
	400	128	4	23148E	23148EK	2610000	3350000	1,000	1,200	12	26	6	258.0	382.0	3.0	0.32	2.13	3.17	2.08	66.6	23148E	23148EK
	400	128	4	23148A2X	23148A2XK	2540000	3250000	1,300	1,600	12	26	6	258.0	382.0	3.0	0.33	2.02	3.00	1.97	68.5	23148A2X	23148A2XK
	400	160	4	24148E	24148EK30	2850000	3700000	1,000	1,200	12	26	6	258.0	382.0	3.0	0.40	1.69	2.51	1.65	81.6	24148E	24148EK30
	440	120	4	22248E	22248EK	2630000	2930000	1,000	1,300	10	22	6	258.0	422.0	3.0	0.28	2.37	3.53	2.32	82.8	22248E	22248EK
	440	160	4	23248E	23248EK	3400000	4100000	945	1,200	12	26	6	258.0	422.0	3.0	0.37	1.80	2.68	1.76	109	23248E	23248EK
	500	155	5	22348E	22348EK	3850000	4100000	1,000	1,200	12	26	6	262.0	487.0	4.0	0.34	2.00	2.98	1.96	151	22348E	22348EK
260	360	75	2.1	23952E	23952EK	1240000	1780000	1,200	1,500	8	14	6	272.0	348.0	2.0	0.19	3.54	5.27	3.46	23.7	23952E	23952EK
	400	104	4	23052E	23052EK	1950000	2530000	1,100	1,400	10	22	6	278.0	382.0	3.0	0.25	2.66	3.97	2.61	48.9	23052E	23052EK
	400	140	4	24052E	24052EK30	2630000	3700000	940	1,200	12	26	6	278.0	382.0	3.0	0.34	1.98	2.94	1.93	65.7	24052E	24052EK30
	440	144	4	23152E	23152EK	3100000	4000000	900	1,100	12	26	6	278.0	422.0	3.0	0.33	2.06	3.06	2.01	92	23152E	23152EK
	440	180	4	24152E	24152EK30	3550000	4650000	900	1,100	15	32	6	278.0	422.0	3.0	0.42	1.59	2.37	1.56	113	24152E	24152EK30
	480	130	5	22252E	22252EK	3100000	3500000	1,000	1,200	12	26	6	282.0	458.0	4.0	0.28	2.40	3.57	2.34	107	22252E	22252EK
	480	174	5	23252E	23252EK	3950000	4800000	840	1,000	15	32	6	282.0	458.0	4.0	0.38	1.78	2.65	1.74	142	23252E	23252EK
	540	165	6	22352E	22352EK	4350000	4750000	900	1,100	15	32	8	288.0	512.0	5.0	0.33	2.04	3.03	1.99	187	22352E	22352EK

Note: Suffix K or K30 means tapered bore (1/12 or 1/30).

Spherical Roller Bearings

Bore Diameter: 280~340mm

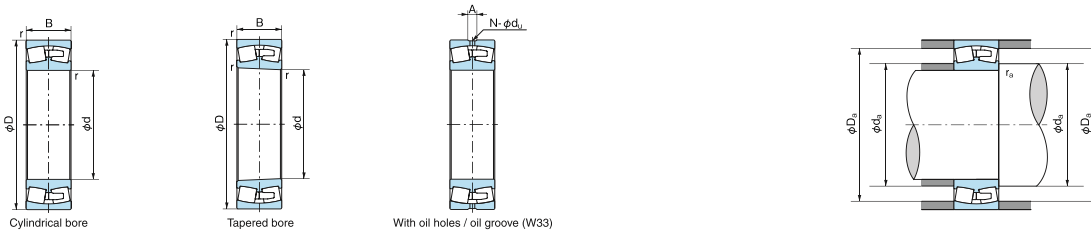

■ Dynamic equivalent radial load

$F_r = XFr + YFa$

	$\frac{F_a}{F_r} \leq e$	$\frac{F_a}{F_r} > e$
X	Y	X
1	Y_1	$0.67 Y_2$

Values of Y_1 , Y_2 and e from table.

■ Static equivalent radial load

$P_0 = Fr + Y_0 Fa$

Values Y_0 from table.

Boundary dimensions (mm)				Bearing No.		Basic dynamic load rating C_r (N)	Basic static load rating C_0 (N)	Limiting speed (min ⁻¹)		Dimensions of lubrication holes and grooves			Abutment and fillet dimensions (mm)			Constant e	Axial load factor			Mass (kg) Cylindrical bore (Reference)	Bearing No.		
d	D	B	r (min)	Cylindrical bore	Tapered bore			Grease lubrication	Oil lubrication	Hole diameter ϕ_s	Groove width A	Hole count N	d_a (min)	D_a (max)	r_a (max)		Y_1	Y_2	Y_0		Cylindrical bore	Tapered bore	
280	380	75	2.1	23956E	23956EK	1260000	1840000	1,100	1,400		8	14	6	292.0	368.0	2.0	0.18	3.75	5.59	3.67	24.9	23956E	23956EK
	420	106	4	23056E	23056EK	2030000	2720000	1,000	1,300		10	22	6	298.0	402.0	3.0	0.24	2.79	4.15	2.73	52.7	23056E	23056EK
	420	140	4	24056E	24056EK30	2680000	3900000	900	1,100		12	26	6	298.0	402.0	3.0	0.32	2.09	3.11	2.04	69.6	24056E	24056EK30
	460	146	5	23156E	23156EK	3200000	4200000	840	1,000		12	26	6	302.0	438.0	4.0	0.32	2.12	3.15	2.07	98.4	23156E	23156EK
	460	180	5	24156E	24156EK30	3550000	4800000	840	1,000		15	32	6	302.0	438.0	4.0	0.39	1.74	2.59	1.70	120	24156E	24156EK30
	500	130	5	22256E	22256EK	3200000	3700000	940	1,200		12	26	6	302.0	478.0	4.0	0.27	2.53	3.77	2.47	113	22256E	22256EK
300	500	176	5	23256E	23256EK	4150000	5200000	790	1,000		15	32	6	302.0	478.0	4.0	0.36	1.87	2.79	1.83	152	23256E	23256EK
	580	175	6	22356E	22356EK	4950000	5450000	840	1,000		15	32	8	308.0	552.0	5.0	0.33	2.07	3.09	2.03	228	22356E	22356EK
	420	90	3	23960E	23960EK	1740000	2520000	1,000	1,200		10	18	6	314.0	406.0	2.5	0.20	3.42	5.08	3.34	39.7	23960E	23960EK
	460	118	4	23060E	23060EK	2500000	3300000	940	1,200		10	22	6	318.0	442.0	3.0	0.25	2.71	4.04	2.65	72.8	23060E	23060EK
	460	160	4	24060E	24060EK30	3350000	4850000	840	1,000		12	26	6	318.0	442.0	3.0	0.34	1.99	2.96	1.94	98.7	24060E	24060EK30
	500	160	5	23160E	23160EK	3650000	4750000	790	1,000		12	26	6	322.0	478.0	4.0	0.33	2.06	3.06	2.01	129	23160E	23160EK
320	500	200	5	24160E	24160EK30	4450000	6100000	790	1,000		15	32	6	322.0	478.0	4.0	0.40	1.68	2.50	1.64	160	24160E	24160EK30
	540	140	5	22260E	22260EK	3700000	4300000	900	1,100		12	26	8	322.0	518.0	4.0	0.27	2.49	3.71	2.43	144	22260E	22260EK
	540	192	5	23260E	23260EK	4950000	6250000	720	900		15	32	8	322.0	518.0	4.0	0.37	1.84	2.73	1.80	196	23260E	23260EK
	620	185	7.5	22360E	22360EK	5500000	6050000	780	970		15	32	8	336.0	584.0	6.0	0.32	2.09	3.11	2.04	279	22360E	22360EK
	440	90	3	23964E	23964EK	1770000	2610000	940	1,200		10	18	6	334.0	426.0	2.5	0.19	3.58	5.33	3.50	41.8	23964E	23964EK
	480	121	4	23064E	23064EK	2590000	3500000	900	1,100		12	26	6	338.0	462.0	3.0	0.24	2.76	4.11	2.70	78.6	23064E	23064EK
340	480	160	4	24064E	24064EK30	3400000	5100000	790	1,000		12	26	6	338.0	462.0	3.0	0.32	2.09	3.11	2.04	104	24064E	24064EK30
	540	176	5	23164E	23164EK	4350000	5700000	720	900		15	32	8	342.0	518.0	4.0	0.33	2.03	3.02	1.98	168	23164E	23164EK
	540	218	5	24164E	24164EK30	5050000	6900000	720	900		15	35	4	342.0	518.0	4.0	0.41	1.65	2.46	1.61	206	24164E	24164EK30
	580	150	5	22264E	22264EK	4250000	4900000	820	1,000		12	26	8	342.0	558.0	4.0	0.27	2.51	3.73	2.45	179	22264E	22264EK
340	580	208	5	23264E	23264EK	5600000	7200000	670	840		20	40	8	342.0	558.0	4.0	0.37	1.83	2.72	1.79	244	23264E	23264EK
	460	90	3	23968E	23968EK	1830000	2790000	900	1,100		10	18	6	354.0	446.0	2.5	0.18	3.80	5.66	3.72	44.1	23968E	23968EK
	520	133	5	23068E	23068EK	3150000	4300000	840	1,000		12	26	8	362.0	498.0	4.0	0.25	2.74	4.08	2.68	104	23068E	23068EK
	520	180	5	24068E	24068EK30	4100000	6050000	720	900		15	32	8	362.0	498.0	4.0	0.34	1.98	2.94	1.93	141	24068E	24068EK30
	580	190	5	23168E	23168EK	5150000	6750000	670	840		15	32	8	362.0	558.0	4.0	0.33	2.03	3.02	1.98	212	23168E	23168EK
	580	243	5	24168E	24168EK30	6050000	8300000	670	840		20	40	8	362.0	558.0	4.0	0.42	1.62	2.42	1.59	267	24168E	24168EK30
340	620	165	6	22268E	22268EK	5600000	6850000	750	930		15	32	8	368.0	592.0	5.0	0.27	2.49	3.71	2.43	224	22268E	22268EK
	620	224	6	23268E	23268EK	6300000	8000000	600	790		20	40	8	368.0	592.0	5.0	0.37	1.82	2.70	1.78	299	23268E	23268EK

Note: Suffix K or K30 means tapered bore (1/12 or 1/30).

Spherical Roller Bearings

Bore Diameter: 360~440mm

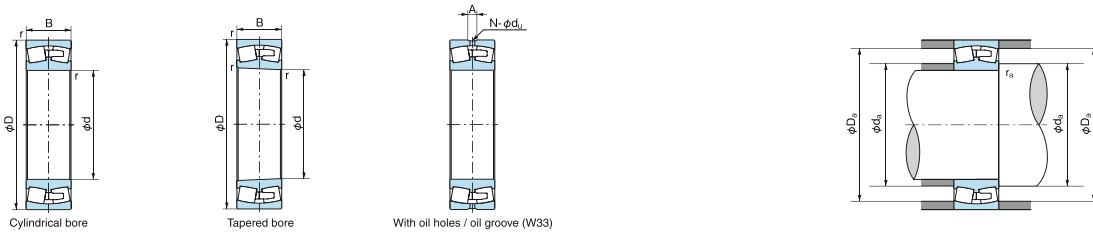

■ Dynamic equivalent radial load
 $F_r = X F_r + Y F_a$

	$\frac{F_a}{F_r} \leq e$	$\frac{F_a}{F_r} > e$
X	Y	X
1	Y_1	$0.67 Y_2$

Values of Y_1 , Y_2 and e from table.

■ Static equivalent radial load
 $P_0 = F_r + Y_0 F_a$

Values Y_0 from table.

Boundary dimensions (mm)				Bearing No.		Basic dynamic load rating C_r (N)	Basic static load rating C_0 (N)	Limiting speed (min ⁻¹)		Dimensions of lubrication holes and grooves	Abutment and fillet dimensions (mm)			Constant e	Axial load factor			Mass (kg) Cylindrical bore (Reference)	Bearing No.			
d	D	B	r (min)	Cylindrical bore	Tapered bore			Grease lubrication	Oil lubrication		Hole diameter ϕ_s	Groove width A	Hole count N		d_a (min)	D_a (max)	r_a (max)		Y_1	Y_2	Y_0	Cylindrical bore
360	480	90	3	23972E	23972EK	1890000	2960000	900	1,100	10	18	6	374.0	466.0	2.5	0.17	4.05	6.03	3.96	46.2	23972E	23972EK
	540	134	5	23072E	23072EK	3200000	4500000	790	1,000	12	26	8	382.0	518.0	4.0	0.24	2.84	4.23	2.78	110	23072E	23072EK
	540	180	5	24072E	24072EK30	4250000	6350000	670	840	15	32	8	382.0	518.0	4.0	0.33	2.06	3.06	2.01	148	24072E	24072EK30
	600	192	5	23172E	23172EK	5350000	7250000	640	790	15	32	8	382.0	578.0	4.0	0.33	2.07	3.09	2.03	225	23172E	23172EK
	600	243	5	24172E	24172EK30	6250000	8750000	640	790	20	40	8	382.0	578.0	4.0	0.42	1.60	2.39	1.57	279	24172E	24172EK30
	650	232	6	23272E	23272EK	6950000	9000000	570	750	20	40	8	388.0	622.0	5.0	0.37	1.82	2.70	1.78	342	23272E	23272EK
380	520	106	4	23976E	23976EK	2390000	3650000	790	1,000	12	24	8	398.0	502.0	3.0	0.19	3.58	5.33	3.50	68.2	23976E	23976EK
	560	135	5	23076E	23076EK	3300000	4700000	750	940	12	26	8	402.0	538.0	4.0	0.23	2.92	4.35	2.86	116	23076E	23076EK
	560	180	5	24076E	24076EK30	4300000	6650000	670	840	15	32	8	402.0	538.0	4.0	0.31	2.15	3.20	2.10	154	24076E	24076EK30
	620	194	5	23176E	23176EK	5400000	7400000	600	750	15	32	8	402.0	598.0	4.0	0.32	2.13	3.17	2.08	236	23176E	23176EK
	620	243	5	24176E	24176EK30	6450000	9300000	600	750	20	40	8	402.0	598.0	4.0	0.40	1.70	2.53	1.66	290	24176E	24176EK30
	680	240	6	23276E	23276EK	7500000	9800000	540	720	20	40	8	408.0	652.0	5.0	0.36	1.86	2.77	1.82	383	23276E	23276EK
400	540	106	4	23980E	23980EK	2470000	3900000	750	940	12	24	8	418.0	522.0	3.0	0.18	3.75	5.59	3.67	71.4	23980E	23980EK
	600	148	5	23080E	23080EK	3900000	5500000	720	900	12	26	8	422.0	578.0	4.0	0.24	2.81	4.19	2.75	151	23080E	23080EK
	600	200	5	24080E	24080EK30	5000000	7650000	600	750	15	32	8	422.0	578.0	4.0	0.33	2.03	3.02	1.98	204	24080E	24080EK30
	650	200	6	23180E	23180EK	5750000	7900000	570	720	15	32	8	428.0	622.0	5.0	0.31	2.18	3.24	2.13	266	23180E	23180EK
	650	250	6	24180E	24180EK30	6900000	9850000	570	720	20	40	8	428.0	622.0	5.0	0.39	1.73	2.57	1.69	330	24180E	24180EK30
	720	256	6	23280E	23280EK	8500000	11100000	510	670	20	45	8	428.0	692.0	5.0	0.36	1.86	2.77	1.82	461	23280E	23280EK
420	560	106	4	23984E	23984EK	2520000	4000000	720	900	12	24	8	438.0	542.0	3.0	0.18	3.85	5.73	3.76	74.4	23984E	23984EK
	620	150	5	23084E	23084EK	4050000	5850000	670	840	12	26	8	442.0	598.0	4.0	0.23	2.92	4.35	2.86	158	23084E	23084EK
	620	200	5	24084E	24084EK30	5150000	8000000	570	720	15	32	8	442.0	598.0	4.0	0.32	2.09	3.11	2.04	212	24084E	24084EK30
	700	224	6	23184E	23184EK	6800000	9250000	540	670	20	40	8	448.0	672.0	5.0	0.33	2.06	3.06	2.01	354	23184E	23184EK
	700	280	6	24184E	24184EK30	8350000	12000000	540	670	20	45	8	448.0	672.0	5.0	0.40	1.68	2.50	1.64	437	24184E	24184EK30
	760	272	7.5	23284E	23284EK	9400000	12500000	490	640	20	45	8	456.0	724.0	6.0	0.37	1.84	2.74	1.80	548	23284E	23284EK
440	600	118	4	23988E	23988EK	3100000	4900000	670	840	12	24	8	458.0	582.0	3.0	0.18	3.66	5.46	3.58	101	23988E	23988EK
	650	157	6	23088E	23088EK	4300000	6250000	640	790	12	26	8	468.0	622.0	5.0	0.24	2.87	4.27	2.80	183	23088E	23088EK
	650	212	6	24088E	24088EK30	5750000	9000000	540	670	20	40	8	468.0	622.0	5.0	0.32	2.09	3.11	2.04	247	24088E	24088EK30
	720	226	6	23188E	23188EK	7150000	10000000	510	640	20	40	8	468.0	692.0	5.0	0.32	2.13	3.17	2.08	371	23188E	23188EK
	720	280	6	24188E	24188EK30	8550000	12700000	510	640	20	45	8	468.0	692.0	5.0	0.39	1.73	2.58	1.69	460	24188E	24188EK30
	790	280	7.5	23288E	23288EK	10000000	13300000	480	600	20	45	8	476.0	754.0	6.0	0.36	1.86	2.77	1.82	605	23288E	23288EK

Note: Suffix K or K30 means tapered bore (1/12 or 1/30).

Spherical Roller Bearings

Bore Diameter : 460~600mm

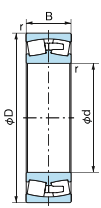

Cylindrical bore

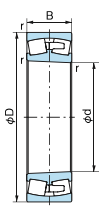

Tapered bore

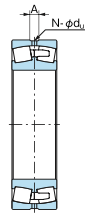

With oil holes / oil groove (W33)

1N=0.102kgf

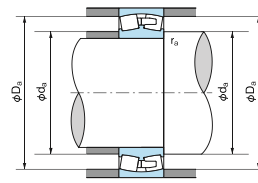

■ Dynamic equivalent radial load

$$F_r = XFr + YFa$$

	$\frac{Fa}{Fr} \leq e$	$\frac{Fa}{Fr} > e$
X	Y	X
1	Y ₁	0.67 Y ₂

Values of Y₁, Y₂ and e from table.

■ Static equivalent radial load

$$P_0 = Fr + Y_0 Fa$$

Values Y₀ from table.

Boundary dimensions (mm)				Bearing No.		Basic dynamic load rating Cr (N)	Basic static load rating Cor (N)	Limiting speed (min ⁻¹)		Dimensions of lubrication holes and grooves				Abutment and fillet dimensions (mm)			Constant e	Axial load factor			Mass (kg) Cylindrical bore (Reference)	Bearing No.	
d	D	B	r (min)	Cylindrical bore	Tapered bore			Grease lubrication	Oil lubrication	Hole diameter φ _s	Groove width A	Hole count N	d _a (min)	D _a (max)	r _a (max)	Y ₁		Y ₂	Y ₀	Cylindrical bore		Tapered bore	
460	620	118	4	23992E	23992EK	3050000	4900000	640	790	12	24	8	478.0	602.0	3.0	0.18	3.85	5.73	3.76	105	23992E	23992EK	
	680	163	6	23092E	23092EK	4700000	6850000	600	750	15	32	8	488.0	652.0	5.0	0.23	2.92	4.35	2.86	208	23092E	23092EK	
	680	218	6	24092E	24092EK30	6100000	9650000	510	640	20	40	8	488.0	652.0	5.0	0.32	2.12	3.15	2.07	279	24092E	24092EK30	
	760	240	7.5	23192E	23192EK	8000000	11200000	480	600	20	40	8	496.0	724.0	6.0	0.32	2.12	3.15	2.07	446	23192E	23192EK	
	760	300	7.5	24192E	24192EK30	9450000	13900000	480	600	20	45	8	496.0	724.0	6.0	0.40	1.69	2.52	1.65	550	24192E	24192EK30	
480	830	296	7.5	23292E	23292EK	10600000	14500000	450	570	20	45	8	496.0	794.0	6.0	0.36	1.85	2.75	1.81	709	23292E	23292EK	
	650	128	5	23996E	23996EK	3300000	5450000	645	790	15	32	8	502.0	628.0	4.0	0.18	3.75	5.59	3.67	126	23996E	23996EK	
	700	165	6	23096E	23096EK	4850000	7250000	570	720	15	32	8	508.0	672.0	5.0	0.22	3.01	4.48	2.94	217	23096E	23096EK	
	700	218	6	24096E	24096EK30	6300000	10100000	510	640	20	40	8	508.0	672.0	5.0	0.31	2.20	3.27	2.15	290	24096E	24096EK30	
	790	248	7.5	23196E	23196EK	8500000	12000000	450	570	20	40	8	516.0	754.0	6.0	0.32	2.12	3.15	2.07	495	23196E	23196EK	
500	790	308	7.5	24196E	24196EK30	9950000	14800000	450	570	20	45	8	516.0	754.0	6.0	0.39	1.71	2.54	1.67	625	24196E	24196EK30	
	870	310	7.5	23296E	23296EK	11300000	15400000	420	540	20	45	8	516.0	834.0	6.0	0.37	1.82	2.70	1.78	820	23296E	23296EK	
	670	128	5	239500E	239500EK	3400000	5700000	600	750	15	28	8	522.0	648.0	4.0	0.18	3.85	5.73	3.76	130	239500E	239500EK	
	720	167	6	230500E	230500EK	5050000	7650000	570	720	15	32	8	528.0	692.0	5.0	0.22	3.07	4.57	3.00	228	230500E	230500EK	
	720	218	6	240500E	240500EK30	6450000	10500000	480	600	20	40	8	528.0	692.0	5.0	0.30	2.26	3.37	2.21	300	240500E	240500EK30	
530	830	264	7.5	231500E	231500EK	9300000	13000000	420	540	20	45	8	536.0	794.0	6.0	0.32	2.09	3.11	2.04	584	231500E	231500EK	
	830	325	7.5	241500E	241500EK30	11000000	16200000	420	540	25	50	8	536.0	794.0	6.0	0.40	1.70	2.53	1.66	718	241500E	241500EK30	
	920	336	7.5	232500E	232500EK	13200000	17800000	390	510	25	50	8	536.0	884.0	6.0	0.38	1.78	2.65	1.74	1000	232500E	232500EK	
	710	136	5	239530E	239530EK	4100000	6800000	540	670	15	28	8	552.0	688.0	4.0	0.18	3.85	5.73	3.76	156	239530E	239530EK	
	780	185	6	230530E	230530EK	6250000	9450000	550	670	15	32	8	558.0	752.0	5.0	0.23	2.98	4.44	2.91	308	230530E	230530EK	
560	780	250	6	240530E	240530EK30	7800000	12500000	450	550	20	40	8	558.0	752.0	5.0	0.32	2.12	3.15	2.07	417	240530E	240530EK30	
	870	272	7.5	231530E	231530EK	10200000	14600000	390	510	20	45	8	566.0	834.0	6.0	0.32	2.13	3.17	2.08	640	231530E	231530EK	
	980	355	9.5	232530E	232530EK	15300000	21000000	330	450	25	60	8	574.0	936.0	8.0	0.37	1.80	2.69	1.76	1215	232530E	232530EK	
	750	140	5	239560E	239560EK	4250000	6950000	510	640	15	28	8	582.0	728.0	4.0	0.17	3.90	5.80	3.81	177	239560E	239560EK	
	820	195	6	230560E	230560EK	7000000	10800000	510	640	15	32	8	588.0	792.0	5.0	0.23	2.95	4.39	2.89	359	230560E	230560EK	
600	820	258	6	240560E	240560EK30	8350000	13500000	420	520	20	45	8	588.0	792.0	5.0	0.31	2.21	3.29	2.16	468	240560E	240560EK30	
	920	280	7.5	231560E	231560EK	11000000	15800000	360	480	20	45	8	596.0	884.0	6.0	0.31	2.20	3.27	2.15	732	231560E	231560EK	
	1030	365	9.5	232560E	232560EK	16000000	22000000	280	400	25	50	8	612.0	992.0	8.0	0.37	1.82	2.70	1.78	1390	232560E	232560EK	
	800	150	5	239600E	239600EK	4800000	8050000	480	600	20	35	8	622.0	778.0	4.0	0.17	3.95	5.87	3.86	214	239600E	239600EK	
	870	200	6	230600E	230600EK	7650000	12000000	480	600	15	32	8	628.0	842.0	5.0	0.22	3.10	4.62	3.03	408	230600E	230600EK	
600	870	272	6	240600E	240600EK30	9050000	14900000	390	490	20	45	8	628.0	842.0	5.0	0.31	2.20	3.27	2.15	551	240600E	240600EK30	
	980	300	7.5	231600E	231600EK	12100000	17500000	300	420	20	45	8	636.0	944.0	6.0	0.31	0.22	3.27	2.15	887	231600E	231600EK	
	1090	388	9.5	232600E	232600EK	17900000	25100000	240	360	25	50	8	654.0	1048	8.0	0.37	1.82	2.70	1.78	1640	232600E	232600EK	

Note: Suffix K or K30 means tapered bore (1/12 or 1/30).

Spherical Roller Bearings

Bore Diameter : 630~1,060mm

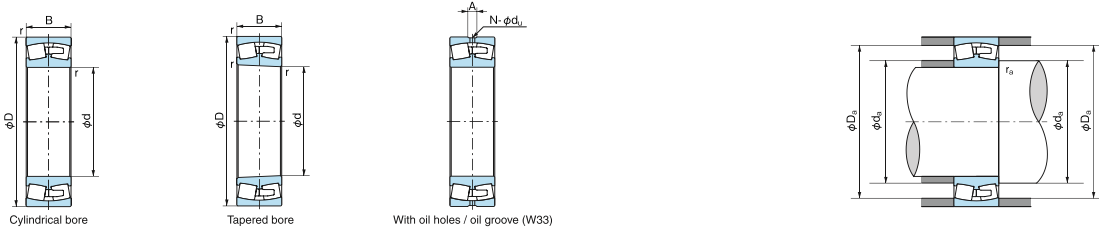

■ Dynamic equivalent radial load
 $F_r = X F_r + Y F_a$

$\frac{F_a}{F_r} \leq e$		$\frac{F_a}{F_r} > e$	
X	Y	X	Y
1	Y ₁	0.67	Y ₂

Values of Y₁, Y₂ and e from table.

■ Static equivalent radial load
 $P_0 = F_r + Y_0 F_a$

Values Y₀ from table.

Boundary dimensions (mm)				Bearing No.		Basic dynamic load rating Cr (N)	Basic static load rating Cor (N)	Limiting speed (min ⁻¹)		Grease lubrication	Oil lubrication	Hole diameter d_h	Groove width A	Hole count N	Abutment and fillet dimensions (mm)			Constant e	Axial load factor				Mass (kg) Cylindrical bore (Reference)	Bearing No.			
d	D	B	r (min)	Cylindrical bore	Tapered bore			Grease lubrication	Oil lubrication						d _a (min)	D _a (max)	r _a (max)		Y ₁	Y ₂	Y ₀	Cylindrical bore		Tapered bore			
630	850	165	6	239/630E	239/630EK			5750000	9700000						420	540						20		35	8	658.0	822.0
	920	212	7.5	230/630E	230/630EK	8350000	13100000	430	570					20	40	8	666.0	884.0	6.0	0.22	3.07	4.57	3.00	487	230/630E	230/630EK	
	1030	315	7.5	231/630E	231/630EK	13500000	19800000	280	390					20	45	8	666.0	994.0	6.0	0.31	2.20	3.27	2.15	1070	231/630E	231/630EK	
	900	170	6	239/670E	239/670EK	6200000	10500000	390	510					20	35	8	698.0	872.0	5.0	0.17	3.90	5.80	3.81	316	239/670E	239/670EK	
	980	230	7.5	230/670E	230/670EK	9650000	15300000	400	510					20	40	8	706.0	944.0	6.0	0.22	3.01	4.48	2.94	603	230/670E	230/670EK	
	980	308	7.5	240/670E	240/670EK30	12000000	19800000	340	430					20	45	8	706.0	944.0	6.0	0.31	2.21	3.29	2.16	801	240/670E	240/670EK30	
	1090	336	7.5	231/670E	231/670EK	15300000	23000000	270	360					25	50	8	706.0	1054	6.0	0.31	2.18	3.24	2.13	1260	231/670E	231/670EK	
	950	180	6	239/710E	239/710EK	6950000	12100000	360	480					20	35	8	738.0	922.0	5.0	0.17	3.90	5.80	3.81	369	239/710E	239/710EK	
	1030	236	7.5	230/710E	230/710EK	10300000	16600000	370	480					20	40	8	746.0	994.0	6.0	0.22	3.10	4.62	3.03	676	230/710E	230/710EK	
	1150	345	9.5	231/710E	231/710EK	16800000	25300000	250	330					25	50	8	754.0	1106	8.0	0.30	2.24	3.34	2.19	1432	231/710E	231/710EK	
	1000	185	6	239/750E	239/750EK	7500000	13200000	330	450					20	35	8	778.0	972.0	5.0	0.17	4.00	5.95	3.91	417	239/750E	239/750EK	
	1090	250	7.5	230/750E	230/750EK	11700000	18900000	340	450					20	40	8	786.0	1054	6.0	0.22	3.10	4.62	3.03	803	230/750E	230/750EK	
	1220	365	9.5	231/750E	231/750EK	18100000	27700000	220	280					25	50	8	794.0	1176	8.0	0.30	2.25	3.34	2.20	1710	231/750E	231/750EK	
	1060	195	6	239/800E	239/800EK	8150000	14500000	300	420					20	35	8	825.0	1032	5.0	0.17	4.00	5.96	3.91	470	239/800E	239/800EK	
	1150	258	7.5	230/800E	230/800EK	12200000	20900000	310	400					20	45	8	836.0	1114	6.0	0.21	3.20	4.77	3.13	910	230/800E	230/800EK	
	1150	345	7.5	240/800E	240/800EK30	15400000	27200000	300	370					25	50	8	836.0	1114	6.0	0.28	2.43	3.61	2.37	1200	240/800E	240/800EK30	
	1280	375	9.5	231/800E	231/800EK	20000000	31000000	240	310					25	50	8	844.0	1236	8.0	0.29	2.32	3.45	2.26	1910	231/800E	231/800EK	
	1120	200	6	239/850E	239/850EK	8600000	15600000	280	390					20	40	8	878.0	1092	5.0	0.16	4.16	6.20	4.07	546	239/850E	239/850EK	
	1220	272	7.5	230/850E	230/850EK	13600000	22500000	285	360					20	40	8	886.0	1184	6.0	0.21	3.20	4.77	3.13	1059	230/850E	230/850EK	
	1180	206	6	239/900E	239/900EK	9300000	17000000	270	360					20	40	8	928.0	1152	5.0	0.16	4.22	6.28	4.13	618	239/900E	239/900EK	
	1280	280	7.5	230/900E	230/900EK	14600000	25400000	270	330					20	45	8	936.0	1244	6.0	0.21	3.27	4.87	3.20	1200	230/900E	230/900EK	
	1250	224	7.5	239/950E	239/950EK	10800000	19900000	250	330					20	40	8	986.0	1214	6.0	0.16	4.11	6.12	4.02	763	239/950E	239/950EK	
	1360	300	7.5	230/950E	230/950EK	16100000	27200000	240	300					20	45	8	986.0	1324	6.0	0.21	3.23	4.82	3.16	1450	230/950E	230/950EK	
	1320	236	7.5	239/1000E	239/1000EK	11600000	21300000	220	300					25	48	8	1036	1284	6.0	0.17	4.05	6.03	3.96	895	239/1000E	239/1000EK	
	1420	308	7.5	230/1000E	230/1000EK	17200000	29700000	220	280					20	45	8	1036	1384	6.0	0.21	3.27	4.87	3.20	1610	230/1000E	230/1000EK	
	1060	1400	250	7.5	239/1060E	239/1060EK	13200000	24500000	210	270					25	48	8	1096	1364	6.0	0.17	4.05	6.03	3.96	1077	239/1060E	239/1060EK

Note: Suffix K or K30 means tapered bore (1/12 or 1/30).



● Design

Thrust Ball Bearings are made as single-direction and double-direction bearings. Single-direction Thrust Ball Bearings can sustain an axial load in only one direction, whereas Double-direction Thrust Ball Bearings can sustain bi-directional thrust load.

Both types of Thrust Ball Bearings cannot sustain a radial load.

Both Thrust Ball Bearings are available with aligning housing washers for mating with a housing having an aligning surface radius. Aligning seat washers with an aligning surface radius are also available for ease of design and mounting against a flat housing shoulder.

The Bearings with a polyamide cage are indicated suffix G at bearing number on package surface.

● Attention

- (1) Thrust Ball Bearings with flat housing washers do not permit any angular misalignment between shaft and housing, nor can they accommodate any error of angle between the support surfaces in the housing and on the shaft.
- (2) They are not suitable for high speed applications. Limiting speed are indicated in the dimension table.
- (3) The outside diameters of shaft washer and housing washer or center washer are the same, so clearance must be provided for the outside diameter of shaft washer or center washer by use of a step in the housing bore (See Fig.1). The outside diameter of the shaft washer or center washer of the bearings that are indicated in Table 2 are smaller than that of the housing washer, so no clearance step is required in the housing for the shaft (center) washer. See Fig.2.
- (4) Bearings with polyamide cage should be used less than 120°C.

Table 1. Thrust Ball Bearings Series

Type	Flat back-face type	Spherical back-face type	With aligning seat
Single-direction	511	—	—
	512	532	532U
	513	533	533U
	514	534	534U
	29	—	—
	39	—	—
	O ⁽¹⁾	—	—
Double-direction	TAM ⁽²⁾	—	—
	TG ⁽²⁾	—	—
	522	542	542U
	523	543	543U
	524	544	544U

Notes: ⁽¹⁾ Series O is inch-dimensioned.
⁽²⁾ Series TAM, TG is extra-small and miniature.

Table 2.

Bearing series	Bore diameter No.
511	28~
512, 522, 532, 542	26~
513, 523, 533, 543	22~
514, 524, 534, 544	17~

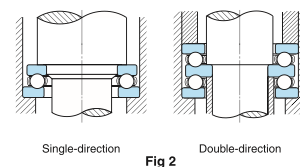
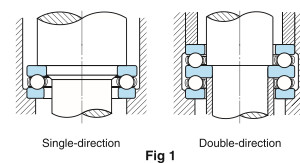

● Cage

Standard fitting cages are shown in Table 3. If other cages are necessary, please contact NACHI.

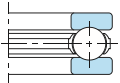

Fig 3. Polyamide

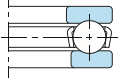

Fig 4. Pressed Steel

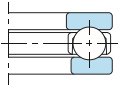

Fig 5. Machined

Table 3. Cage of Thrust Ball Bearings

Series	Diameter Number		
	Polyamide	Pressed Steel	Machined
511	00~07	08~52	56~72
512	01~07	00, 08~28	30~72
513	—	05~20	22~40
514	—	05~14	15~36
522	02~07	00, 08~28	30~44
523	—	05~20	22~40
524	—	05~14	15~36
532	01~07	00, 08~28	30~72
533	—	05~20	22~40
534	—	05~14	15~36
542	02~07	08~28	30~44
543	—	05~20	22~24
544	—	05~14	15~20
29	—	00~22	23~28
39	—	05~24	—
O	—	3~30	32~48
TAM	—	3~8(*)	—
TG	—	5~8(*)	—

Remark: Basic load rating of dimension table are indicated in using cage of table 3.
Note: (*) Indicate bore diameter not bore number.

Table 4. Minimum axial factor K (×10⁻⁶)

Bore No.	Series	Series				Bore No.	Series	Series		Bore No.	Series	Series	
		511	512, 522	513, 523	514, 524			29	39			0	0
00	—	1.03	1.55	—	—	00	1.55	—	3	1.34	—	—	
01	—	1.26	1.92	—	—	01	1.92	—	4	3.62	—	—	
02	—	1.56	3.36	—	—	02	2.64	—	5	4.65	—	—	
03	—	1.84	4.09	—	—	03	3.30	—	6	6.40	—	—	
04	—	3.42	7.33	—	—	04	3.82	—	7	7.76	—	—	
05	—	7.19	13.1	20.4	43.8	04 1/2	6.41	—	8	9.24	—	—	
06	—	9.36	17.2	33.1	81.4	05	7.51	14.2	9	11.6	—	—	
07	—	11.2	32.8	58.3	128	06	9.72	28.9	10	16.5	—	—	
08	—	20.4	49.7	97.2	221	07	20.1	52.3	11	19.0	—	—	
09	—	24.6	57.9	138	316	08	25.1	81.0	12	23.0	—	—	
10	—	29.3	66.8	211	440	09	31.6	140	13	21.0	—	—	
11	—	44.6	133	326	656	10	46.1	209	14	31.3	—	—	
12	—	64.7	160	375	956	11	54.4	284	15	42.1	—	—	
13	—	72.0	179	428	1240	12	60.7	350	16	46.9	—	—	
14	—	82.8	200	596	1580	13	86.0	426	17	75.0	—	—	
15	—	94.3	222	808	1800	14	99.5	556	18	82.8	—	—	
16	—	103	245	907	2230	15	114	704	19	110	—	—	
17	—	116	359	1240	2740	16	152	927	20	121	—	—	
18	—	187	528	1390	4320	17	172	1210	21	132	—	—	
20	—	363	850	1850	4790	18	187	1580	22	176	—	—	
22	—	423	1010	2740	8220	19	286	2010	23	204	—	—	
24	—	488	1130	4130	9980	20	321	2090	24	223	—	—	
26	—	648	1940	5140	16100	21	346	2390	26	350	—	—	
28	—	782	2150	6330	16900	22	361	3220	28	395	—	—	
30	—	886	2490	7140	25800	23	350	3940	30	431	—	—	
32	—	997	2880	9960	30000	24	538	4500	32	580	—	—	
34	—	1420	3940	11100	40100	25	498	—	36	1100	—	—	
36	—	1540	4330	15800	46330	26	—	—	40	1730	—	—	
38	—	2340	6290	23100	—	27	—	—	44	2840	—	—	
40	—	2520	6880	29700	—	28	794	—	48	3690	—	—	
44	—	3000	8130	—	—	—	—	—	—	—	—	—	
48	—	4900	15900	—	—	—	—	—	—	—	—	—	
52	—	5580	18400	—	—	—	—	—	—	—	—	—	
56	—	9800	20400	—	—	—	—	—	—	—	—	—	
60	—	14600	38000	—	—	—	—	—	—	—	—	—	
64	—	16400	41800	—	—	—	—	—	—	—	—	—	
68	—	18300	45700	—	—	—	—	—	—	—	—	—	
72	—	20300	75600	—	—	—	—	—	—	—	—	—	

● Minimum axial load

When Thrust Ball Bearings are run at high speeds, the contact angle between the ball and the raceway in the radial plane is affected by the centrifugal force of the balls and the sliding movement between the balls and raceways are occurred. The sliding movement may cause damage as smearing. To prevent this damage, Thrust Ball Bearings must be subjected to a given load more than a minimum load from function (1) or (2).

Single-direction Thrust Ball Bearings can sustain only one direction axial load, so if bi-direction axial loads are present, Double-direction Thrust Ball Bearings must be used and preloaded by

a load more than the minimum load.

In case of a vertical axis, shaft weight often exceeds the minimum load. In this case, the acting load may be decreased by the external axial load acting in the opposite direction.

$$F_{a \min} = K \cdot n^2 \dots\dots\dots (1)$$

$$F_{a \min} = \frac{C_{0a}}{1000} \dots\dots\dots (2)$$

Use the larger result of (1) or (2)

F_{a min}: Minimum axial load (N)

K: inimum axial factor see Table 4

n: Rotating speed (min⁻¹)

C_{0a}: Basic static load rating (N)

Single-direction Thrust Ball Bearings

Bore Diameter: 10~50mm

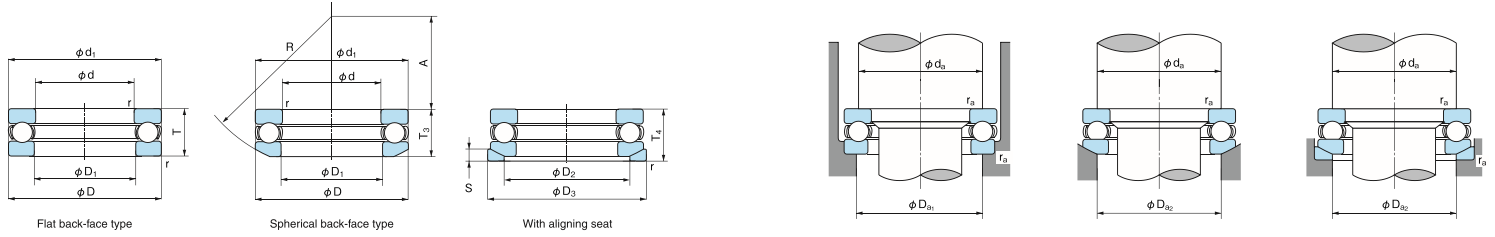

1N=0.102kgf

d	Boundary dimensions (mm)					r (min)	Bearing No.			Basic dynamic load rating Ca (N)	Basic static load rating Coa (N)	Limiting speed (min ⁻¹)		Dimensions (mm)							Abutment and fillet dimensions (mm)				Mass (kg) Reference			Bearing No.
	D	T	T3	T4	T		Flat back-face type	Spherical back-face type	With aligning seat			Grease lubrication	Oil lubrication	D1 (min)	d1 (max)	D2	D3	S	R	A	da (min)	Da1 (max)	Da2 (max)	ra (max)	Flat back-face type	Spherical back-face type	With aligning seat	
10	24	9	—	—	0.3	51100	—	—	10000	14000	6800	10000	11	24	—	—	—	18	16	—	0.3	0.020	—	—	51100			
	26	11	11.6	13	0.6	51200	53200	53200U	12700	17100	5900	8800	12	26	18	28	3.5	22	8.5	20	16	18	0.6	0.030	0.029	0.036	51200	
12	26	9	—	—	0.3	51101	—	—	10300	15400	6500	9800	13	26	—	—	—	20	18	—	0.3	0.022	—	—	51101			
	28	11	11.4	13	0.6	51201	53201	53201U	13200	19000	5600	8500	14	28	20	30	3.5	25	11.5	22	18	20	0.6	0.034	0.033	0.041	51201	
15	28	9	—	—	0.3	51102	—	—	10500	16800	6200	9400	16	28	—	—	—	23	20	—	0.3	0.024	—	—	51102			
	32	12	13.3	15	0.6	51202	53202	53202U	16600	24800	5100	7600	17	32	24	35	4	28	12	25	22	24	0.6	0.046	0.048	0.061	51202	
17	30	9	—	—	0.3	51103	—	—	10800	18200	6000	9100	18	30	—	—	—	25	22	—	0.3	0.028	—	—	51103			
	35	12	13.2	15	0.6	51203	53203	53203U	17100	27300	4800	7300	19	35	26	38	4	32	16	28	24	26	0.6	0.053	0.055	0.070	51203	
20	35	10	—	—	0.3	51104	—	—	14300	24700	5300	8000	21	35	—	—	—	29	26	—	0.3	0.040	—	—	51104			
	40	14	14.7	17	0.6	51204	53204	53204U	22200	37500	4200	6300	22	40	30	42	5	36	18	32	28	30	0.6	0.082	0.080	0.100	51204	
25	42	11	—	—	0.6	51105	—	—	19500	37000	4600	6900	26	42	—	—	—	35	32	—	0.6	0.059	—	—	51105			
	47	15	16.7	19	0.6	51205	53205	53205U	27800	50500	3700	5600	27	47	36	50	5.5	40	19	38	34	36	0.6	0.120	0.125	0.160	51205	
30	52	18	19.8	22	1	51305	53305	53305U	35500	61500	3200	4900	27	52	38	55	6	45	21	41	36	38	1	0.180	0.185	0.225	51305	
	60	24	26.4	29	1	51405	53405	53405U	55500	89500	2600	3900	27	60	42	62	8	50	19	46	39	42	1	0.340	0.350	0.420	51405	
35	47	11	—	—	0.6	51106	—	—	20400	42000	4300	6500	32	47	—	—	—	40	37	—	0.6	0.068	—	—	51106			
	52	16	17.8	20	0.6	51206	53206	53206U	29300	58000	3400	5200	32	52	42	55	5.5	45	22	43	39	42	0.6	0.150	0.160	0.195	51206	
40	60	21	22.6	25	1	51306	53306	53306U	42500	78500	2800	4200	32	60	45	62	7	50	22	48	42	45	1	0.270	0.270	0.325	51306	
	70	28	30.1	33	1	51406	53406	53406U	72500	126000	2200	3300	32	70	50	75	9	56	20	54	46	50	1	0.530	0.530	0.680	51406	
45	52	12	—	—	0.6	51107	—	—	20400	44500	4000	6000	37	52	—	—	—	45	42	—	0.6	0.085	—	—	51107			
	62	18	19.9	22	1	51207	53207	53207U	39000	78000	2900	4400	37	62	48	65	7	50	24	51	46	48	1	0.220	0.220	0.290	51207	
50	68	24	25.6	28	1	51307	53307	53307U	55500	105000	2400	3700	37	68	52	72	7.5	56	24	55	48	52	1	0.390	0.390	0.475	51307	
	80	32	34	37	1.1	51407	53407	53407U	87000	155000	1900	2900	37	80	58	85	10	64	23	62	53	58	1	0.790	0.790	0.950	51407	
55	60	13	—	—	0.6	51108	—	—	26900	63000	3500	5300	42	60	—	—	—	52	48	—	0.6	0.120	—	—	51108			
	68	19	20.3	23	1	51208	53208	53208U	47000	98500	2700	4100	42	68	55	72	7	56	28.5	57	51	55	1	0.270	0.270	0.340	51208	
60	78	26	28.5	31	1	51308	53308	53308U	69000	135000	2200	3300	42	78	60	82	8.5	64	28	63	55	60	1	0.550	0.570	0.690	51308	
	90	36	38.2	42	1.1	51408	53408	53408U	112000	205000	1700	2600	42	90	65	95	12	72	26	70	60	65	1	1.14	1.13	1.38	51408	
65	65	14	—	—	0.6	51109	—	—	27800	69000	3300	4900	47	65	—	—	—	57	53	—	0.6	0.150	—	—	51109			
	73	20	21.3	24	1	51209	53209	53209U	47500	105000	2600	3900	47	73	60	78	7.5	56	26	62	56	60	1	0.320	0.320	0.410	51209	
70	85	28	30.1	33	1	51309	53309	53309U	80000	163000	2000	3000	47	85	65	90	10	64	25	69	61	65	1	0.690	0.680	0.850	51309	
	100	39	42.4	46	1.1	51409	53409	53409U	129000	243000	1600	2400	47	100	72	105	12.5	80	29	78	67	72	1	1.47	1.50	1.80	51409	
75	70	14	—	—	0.6	51110	—	—	28800	75500	3100	4700	52	70	—	—	—	62	58	—	0.6	0.160	—	—	51110			
	78	22	23.5	26	1	51210	53210	53210U	48500	112000	2400	3600	52	78	62	82	7.5	64	32.5	67	61	62	1	0.390	0.380	0.480	51210	
80	95	31	34.3	37	1.1	51310	53310	53310U	96500	202000	1800	2700	52	95	72	100	11	72	28	77	68	72	1	1.00	1.00	1.25	51310	
	110	43	45.6	50	1.5	51410	53410	53410U	148000	283000	1400	2100	52	110	80	115	14	90	35	86	74	80	1.5	1.99	1.97	2.40	51410	

Single-direction Thrust Ball Bearings

Bore Diameter: 55~100mm

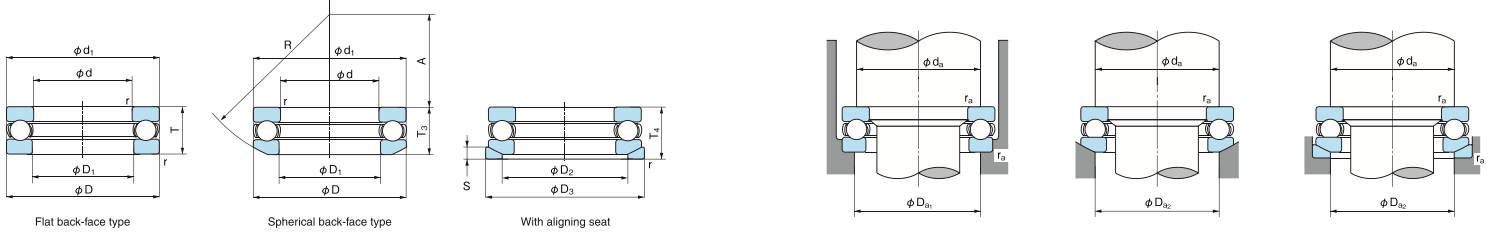

1N=0.102kgf

Boundary dimensions (mm)						Bearing No.			Basic dynamic load rating Ca (N)	Basic static load rating Coa (N)	Limiting speed (min ⁻¹)		Dimensions (mm)						Abutment and fillet dimensions (mm)				Mass (kg) Reference			Bearing No.	
d	D	T	T ₃	T ₄	r (min)	Flat back-face type	Spherical back-face type	With aligning seat			Grease lubrication	Oil lubrication	D ₁ (min)	d ₁ (max)	D ₂	D ₃	S	R	A	d _a (min)	D _{a1} (max)	D _{a2} (max)	r _a (max)	Flat back-face type	Spherical back-face type		With aligning seat
55	78	16	—	—	0.6	51111	—	—	35000	93000	2800	4200	57	78	—	—	—	—	69	64	—	0.6	0.240	—	—	51111	
	90	25	27.3	30	1	51211	53211	53211U	69500	159000	2100	3100	57	90	72	95	9	72	35	76	69	72	1	0.610	0.620	0.800	51211
	105	35	39.3	42	1.1	51311	53311	53311U	120000	246000	1600	2400	57	105	80	110	11.5	80	30	85	75	80	1	1.34	1.40	1.70	51311
	120	48	50.5	55	1.5	51411	53411	53411U	178000	360000	1300	1900	57	120	88	125	15.5	90	28	94	81	88	1.5	2.64	2.55	3.70	51411
60	85	17	—	—	1	51112	—	—	41500	113000	2600	3900	62	85	—	—	—	—	75	70	—	1	0.290	—	—	51112	
	95	26	28	31	1	51212	53212	53212U	73500	179000	2000	3000	62	95	78	100	9	72	32.5	81	74	78	1	0.690	0.690	0.850	51212
	110	35	38.3	42	1.1	51312	53312	53312U	123000	267000	1600	2400	62	110	85	115	11.5	90	41	90	80	85	1	1.43	1.45	1.75	51312
	130	51	54	58	1.5	51412	53412	53412U	213000	435000	1200	1800	62	130	95	135	16	100	34	102	88	95	1.5	3.30	3.25	3.85	51412
65	90	18	—	—	1	51113	—	—	41500	117000	2400	3700	67	90	—	—	—	—	80	75	—	1	0.340	—	—	51113	
	100	27	28.7	32	1	51213	53213	53213U	75000	189000	1900	2800	67	100	82	105	9	80	40	86	79	82	1	0.770	0.770	0.940	51213
	115	36	39.4	43	1.1	51313	53313	53313U	127000	287000	1500	2300	67	115	90	120	12.5	90	38.5	95	85	90	1	1.57	1.60	1.95	51313
	140	56	60.2	65	2	51413	53413	53413U	231000	495000	1100	1600	68	140	100	145	17.5	112	40	110	95	100	2	4.18	4.17	4.95	51413
70	95	18	—	—	1	51114	—	—	43000	127000	2400	3600	72	95	—	—	—	—	85	80	—	1	0.360	—	—	51114	
	105	27	28.8	32	1	51214	53214	53214U	76000	199000	1800	2800	72	105	88	110	9	80	38	91	84	88	1	0.810	0.800	0.980	51214
	125	40	44.2	48	1.1	51314	53314	53314U	148000	340000	1400	2100	72	125	98	130	13	100	43	103	92	98	1	2.06	2.15	2.55	51314
	150	60	63.6	69	2	51414	53414	53414U	250000	555000	1000	1500	73	150	110	155	19.5	112	34	118	102	110	2	5.11	4.94	5.93	51414
75	100	19	—	—	1	51115	—	—	44500	136000	2200	3400	77	100	—	—	—	—	90	85	—	1	0.420	—	—	51115	
	110	27	28.3	32	1	51215	53215	53215U	77500	209000	1800	2700	77	110	92	115	9.5	90	49	96	89	92	1	0.860	0.840	1.05	51215
	135	44	48.1	52	1.5	51315	53315	53315U	170000	395000	1200	1900	77	135	105	140	15	100	37	111	99	105	1.5	2.68	2.70	3.25	51315
	160	65	69	75	2	51415	53415	53415U	252000	560000	950	1400	78	160	115	165	21	125	42	126	109	115	2	6.35	6.25	7.60	51415
80	105	19	—	—	1	51116	—	—	44500	141000	2200	3300	82	105	—	—	—	—	95	90	—	1	0.430	—	—	51116	
	115	28	29.5	33	1	51216	53216	53216U	78500	219000	1700	2600	82	115	98	120	10	90	46	101	94	98	1	0.950	0.930	1.16	51216
	140	44	47.6	52	1.5	51316	53316	53316U	176000	425000	1200	1800	82	140	110	145	15	112	50	116	104	110	1.5	2.82	2.85	3.45	51316
	170	68	72.2	78	2.1	51416	53416	53416U	270000	620000	900	1300	83	170	125	175	22	125	36	134	116	125	2	7.97	7.83	9.14	51416
85	110	19	—	—	1	51117	—	—	46000	150000	2100	3200	87	110	—	—	—	—	100	95	—	1	0.460	—	—	51117	
	125	31	33.1	37	1	51217	53217	53217U	95500	264000	1600	2400	88	125	105	130	11	100	52	109	101	105	1	1.29	1.29	1.60	51217
	150	49	53.1	58	1.5	51317	53317	53317U	206000	490000	1100	1700	88	150	115	155	17.5	112	43	124	111	115	1.5	3.66	3.65	4.45	51317
	180	72	77	83	2.1	51417	53417	53417U	288000	685000	850	1200	88	177	130	185	23	140	47	142	123	130	2	9.30	9.20	10.9	51417
90	120	22	—	—	1	51118	—	—	59500	190000	1900	2900	92	120	—	—	—	—	108	102	—	1	0.680	—	—	51118	
	135	35	38.5	42	1.1	51218	53218	53218U	116000	325000	1400	2100	93	135	110	140	13.5	100	45	117	108	110	1	1.77	1.78	2.22	51218
	155	50	54.6	59	1.5	51318	53318	53318U	213000	525000	1100	1600	93	155	120	160	18	112	40	129	116	120	1.5	3.88	3.84	4.70	51318
	190	77	81.2	88	2.1	51418	53418	53418U	305000	750000	790	1100	93	187	140	195	25.5	140	40	150	130	140	2	11.0	10.7	12.6	51418
100	135	25	—	—	1	51120	—	—	85000	268000	1700	2500	102	135	—	—	—	—	121	114	—	1	0.990	—	—	51120	
	150	38	40.9	45	1.1	51220	53220	53220U	146000	410000	1300	1900	103	150	125	155	14	112	52	130	120	125	1	2.36	2.36	2.87	51220
	170	55	59.2	64	1.5	51320	53320	53320U	236000	595000	1000	1500	103	170	135	175	18	125	46	142	128	135	1.5	5.11	5.12	6.10	51320
	210	85	90	98	3	51420	53420	53420U	345000	895000	710	1000	103	205	155	220	27	160	50	166	144	155	2.5	14.7	14.5	17.2	51420

Single-direction Thrust Ball Bearings

Bore Diameter: 110~190mm

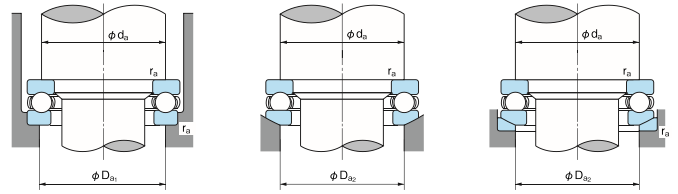
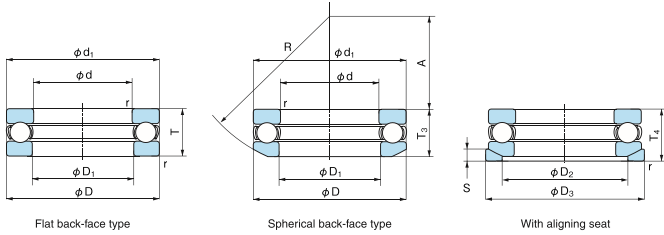

1N=0.102kgf

Boundary dimensions (mm)						Bearing No.			Basic dynamic load rating Ca (N)	Basic static load rating Coa (N)	Limiting speed (min ⁻¹)		Dimensions (mm)						Abutment and fillet dimensions (mm)			Mass (kg) Reference			Bearing No.		
d	D	T	T3	T4	r (min)	Flat back-face type	Spherical back-face type	With aligning seat			Grease lubrication	Oil lubrication	D1 (min)	d1 (max)	D2	D3	S	R	A	da (min)	Da1 (max)	Da2 (max)	ra (max)	Flat back-face type		Spherical back-face type	With aligning seat
110	145	25	—	—	1	51122	—	—	87000	288000	1600	2400	112	145	—	—	—	—	131	124	—	1	1.08	—	—	51122	
	160	38	40.2	45	1.1	51222	53222	53222U	152000	450000	1200	1900	113	160	135	165	14	125	65	140	130	135	1	2.57	2.53	3.00	51222
	190	63	67.2	72	2	51322	53322	53322U	267000	705000	880	1300	113	187	150	195	20.5	140	51	158	142	150	2	7.73	7.66	8.96	51322
	230	95	99.7	109	3	51422	53422	53422U	435000	1240000	640	960	113	225	170	240	29	180	59	182	158	170	2.5	19.8	19.4	22.9	51422
120	155	25	—	—	1	51124	—	—	89000	305000	1600	2400	122	155	—	—	—	—	141	134	—	1	1.16	—	—	51124	
	170	39	40.8	46	1.1	51224	53224	53224U	154000	470000	1200	1800	123	170	145	175	15	125	61	150	140	145	1	2.86	2.76	3.40	51224
	210	70	74.1	80	2.1	51324	53324	53324U	310000	870000	790	1100	123	205	165	220	22	160	63	174	156	165	2	10.6	10.4	12.4	51324
	250	102	107.3	118	4	51424	53424	53424U	455000	1340000	580	880	123	245	185	260	32	200	70	198	172	185	3	25.0	24.6	29.2	51424
130	170	30	—	—	1	51126	—	—	104000	350000	1300	2000	132	170	—	—	—	—	154	145	—	1	1.87	—	—	51126	
	190	45	47.9	53	1.5	51226	53226	53226U	203000	620000	1000	1500	133	187	160	195	17	140	67	166	154	160	1.5	4.10	4.03	4.91	51226
	225	75	80.3	86	2.1	51326	53326	53326U	330000	960000	730	1100	134	220	177	235	26	160	53	187	168	177	2	12.7	12.6	15.2	51326
	270	110	115.2	128	4	51426	53426	53426U	555000	1750000	540	810	134	265	200	280	38	200	58	214	186	200	3	31.4	30.4	36.7	51426
140	180	31	—	—	1	51128	—	—	107000	375000	1300	1900	142	178	—	—	—	—	164	156	—	1	2.03	—	—	51128	
	200	46	48.6	55	1.5	51228	53228	53228U	205000	650000	1000	1500	143	197	170	210	17	160	87	176	164	170	1.5	4.47	4.40	5.61	51228
	240	80	84.9	92	2.1	51328	53328	53328U	350000	1050000	680	1000	144	235	190	250	26	180	68	200	180	190	2	15.5	15.3	18.2	51328
	280	112	117	131	4	51428	53428	53428U	545000	1750000	520	780	144	275	206	290	38	225	83	224	196	206	3	33.9	32.9	39.9	51428
150	190	31	—	—	1	51130	—	—	109000	400000	1200	1900	152	188	—	—	—	—	174	166	—	1	2.16	—	—	51130	
	215	50	53.3	60	1.5	51230	53230	53230U	213000	650000	940	1400	153	212	180	225	20.5	160	79	189	176	180	1.5	5.74	5.60	7.28	51230
	250	80	83.7	92	2.1	51330	53330	53330U	360000	1130000	670	1000	154	245	200	260	26	200	89.5	210	190	200	2	16.3	16.0	19.1	51330
	300	120	125.9	140	4	51430	53430	53430U	615000	2010000	480	720	154	295	225	310	41	225	69	240	210	225	3	41.6	40.5	48.5	51430
160	200	31	—	—	1	51132	—	—	112000	425000	1200	1800	162	198	—	—	—	—	184	176	—	1	2.27	—	—	51132	
	225	51	54.7	61	1.5	51232	53232	53232U	223000	720000	900	1300	163	222	190	235	21	160	74	223	202	190	1.5	6.64	6.50	8.29	51232
	270	87	91.7	100	3	51332	53332	53332U	410000	1340000	610	920	164	265	215	280	29	200	77	226	204	215	2.5	21.0	20.5	24.5	51332
	320	130	135.3	150	5	51432	53432	53432U	680000	2410000	440	670	164	315	240	330	41.5	250	84	256	224	240	4	51.2	49.7	58.9	51432
170	215	34	—	—	1.1	51134	—	—	134000	510000	1100	1700	172	213	—	—	—	—	197	188	—	1	3.27	—	—	51134	
	240	55	58.7	65	1.5	51234	53234	53234U	261000	835000	840	1200	173	237	200	250	21.5	180	91	212	198	200	1.5	8.13	7.89	9.95	51234
	280	87	91.3	100	3	51334	53334	53334U	420000	1430000	600	900	174	275	220	290	29	225	105	230	210	220	2.5	22.0	21.3	25.7	51334
	340	135	141	156	5	51434	53434	53434U	755000	2730000	420	630	174	335	255	350	46	250	74	272	238	255	4	60.1	58.1	69.1	51434
180	225	34	—	—	1.1	51136	—	—	135000	525000	1100	1600	183	222	—	—	—	—	207	198	—	1	3.37	—	—	51136	
	250	56	58.2	66	1.5	51236	53236	53236U	266000	875000	810	1200	183	247	210	260	21.5	200	112	222	208	210	1.5	8.69	8.26	10.5	51236
	300	95	99.3	109	3	51336	53336	53336U	485000	1700000	550	820	184	295	240	310	32	225	91	252	228	240	2.5	28.2	27.0	32.0	51336
	360	140	148.3	164	5	51436	53436	53436U	785000	2980000	400	600	184	355	270	370	46.5	280	97	288	252	270	4	69.5	68.8	81.5	51436
190	240	37	—	—	1.1	51138	—	—	170000	655000	1000	1500	193	237	—	—	—	—	220	210	—	1	3.95	—	—	51138	
	270	62	65.7	73	2	51238	53238	53238U	310000	1060000	740	1100	194	267	230	280	23	200	98	238	222	230	2	11.7	11.5	14.0	51238
	320	105	111	121	4	51338	53338	53338U	570000	2100000	500	750	195	315	255	330	33	250	104	268	242	255	3	36.1	35.8	41.9	51338

Single-direction Thrust Ball Bearings

Bore Diameter: 200~360mm

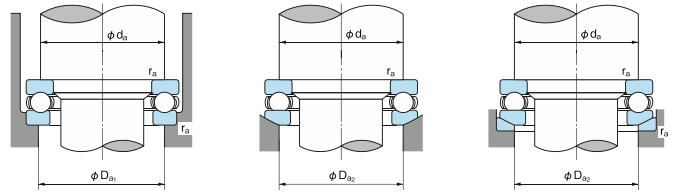
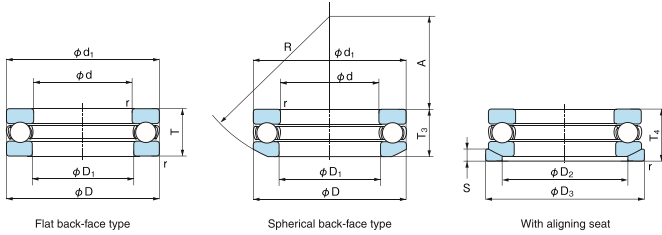

1N=0.102kgf

d	Boundary dimensions (mm)					Bearing No.			Basic dynamic load rating Ca (N)	Basic static load rating Coa (N)	Limiting speed (min ⁻¹)		Dimensions (mm)						Abutment and fillet dimensions (mm)				Mass (kg) Reference			Bearing No.	
	D	T	T ₃	T ₄	r (min)	Flat back-face type	Spherical back-face type	With aligning seat			Grease lubrication	Oil lubrication	D ₁ (min)	d ₁ (max)	D ₂	D ₃	S	R	A	d _a (min)	D _{a1} (max)	D _{a2} (max)	r _a (max)	Flat back-face type	Spherical back-face type		With aligning seat
	200	250	37	—	—	1.1	51140	—			—	172000	675000	1000	1500	203	247	—	—	—	—	230	220	—	1		4.14
200	280	62	65.3	74	2	51240	53240	53240U	315000	1110000	720	1000	204	277	240	290	23	225	125	248	232	240	2	12.2	12.0	14.8	51240
	340	110	118.4	130	4	51340	53340	53340U	625000	2380000	470	710	205	335	270	350	38	250	92	284	256	270	3	43.0	43.1	51.0	51340
	220	270	37	—	—	1.1	51144	—	—	177000	740000	970	1400	223	267	—	—	—	—	250	240	—	1	4.51	—	—	51144
220	300	63	65.6	75	2	51244	53244	53244U	325000	1210000	690	1000	224	297	260	310	25	225	118	268	252	260	2	13.5	13.0	16.2	51244
	340	78	81.6	92	2.1	51248	53248	53248U	430000	1730000	570	860	243	297	—	—	—	—	276	264	—	1.5	7.35	—	—	51148	
	240	340	78	81.6	92	2.1	51248	53248U	430000	1730000	570	860	244	335	290	350	30	250	122	300	280	290	2	23.1	22.3	27.4	51248
260	320	45	—	—	1.5	51152	—	—	232000	990000	800	1200	263	317	—	—	—	—	296	284	—	1.5	7.94	—	—	51152	
	360	79	82.8	93	2.1	51252	53252	53252U	445000	1880000	550	830	264	355	305	370	30	280	152	320	300	305	2	25.0	24.0	29.7	51252
	280	350	53	—	—	1.5	51156	—	—	315000	1350000	700	1000	283	347	—	—	—	—	322	308	—	1.5	12.0	—	—	51156
280	380	80	85	94	2.1	51256	53256	53256U	450000	1950000	530	800	284	375	325	390	31	280	143	340	320	325	2	27.0	26.2	32.3	51256
	300	380	62	—	—	2	51160	—	—	370000	1660000	610	920	304	376	—	—	—	—	348	332	—	2	17.1	—	—	51160
	320	420	95	100.5	112	3	51260	53260	53260U	585000	2720000	450	680	304	415	360	430	34	320	164	372	348	360	2.5	42.3	41.7	49.9
320	400	63	—	—	2	51164	—	—	380000	1760000	590	880	324	396	—	—	—	—	368	352	—	2	18.5	—	—	51164	
	440	95	100.5	112	3	51264	53264	53264U	595000	2830000	440	660	325	435	380	450	36	320	157	392	368	380	2.5	44.7	43.8	52.7	51264
	340	420	64	—	—	2	51168	—	—	385000	1860000	570	850	344	418	—	—	—	—	388	372	—	2	19.9	—	—	51168
340	460	96	100.3	113	3	51268	53268	53268U	600000	2940000	430	640	345	455	400	470	36	360	199	412	388	400	2.5	47.6	46.4	56.2	51268
	360	440	65	—	—	2	51172	—	—	395000	1960000	550	820	364	436	—	—	—	—	408	392	—	2	20.4	—	—	51172
	360	500	110	116.7	130	4	51272	53272U	745000	3800000	380	570	365	495	430	510	43	360	172	444	416	430	3	69.0	67.7	81.5	51272

Single-direction Thrust Ball Bearings

Series 2900

Bore Diameter: 10~140mm

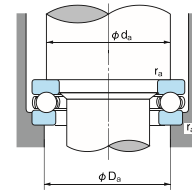
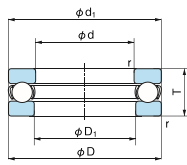

1N=0.102kgf

Boundary dimensions (mm)				Bearing No.	Basic dynamic load rating Ca (N)	Basic static load rating Coa (N)	Limiting speed (min ⁻¹)		Dimensions (mm)		Abutment and fillet dimensions (mm)			Mass (kg) Reference	Bearing No.
d	D	T	r (min)				Grease lubrication	Oil lubrication	D ₁ (min)	d ₁ (max)	d _a (min)	D _a (max)	r _a (max)		
10	26	12	0.6	2900	12700	17100	5600	8400	10.2	26	19.6	16.4	0.6	0.035	2900
12	28	12	0.6	2901	13200	19000	5400	8100	12.2	28	21.6	18.4	0.6	0.037	2901
15	31	12	0.6	2902	14300	22800	5100	7700	15.2	31	25	21	0.6	0.041	2902
18	35	12	0.6	2903	14400	24700	4800	7300	18.2	35	28	25	0.6	0.045	2903
20	37	12	0.6	2904	14800	26600	4700	7100	20.2	37	30	27	0.6	0.055	2904
22	42	14	0.6	2904½	18900	34500	4100	6100	22.2	42	34	30	0.6	0.085	2904½
25	45	14	0.6	2905	19300	37000	3900	5900	25.2	45	37	33	0.6	0.093	2905
30	50	14	0.6	2906	20200	42000	3700	5600	30.2	50	42	38	0.6	0.107	2906
35	55	16	0.6	2907	29900	62000	3300	5000	35.2	55	47	43	0.6	0.137	2907
40	60	16	0.6	2908	31000	70000	3200	4800	40.2	60	52	48	0.6	0.150	2908
45	68	16	0.6	2909	32500	77500	3000	4500	45.2	68	59	54	0.6	0.199	2909
50	74	18	0.6	2910	38500	94000	2700	4100	50.2	74	64	60	0.6	0.255	2910
55	78	18	0.6	2911	40000	103000	2600	4000	55.2	78	69	64	0.6	0.270	2911
60	82	18	0.6	2912	40500	108000	2600	3900	60.2	82	73	69	0.6	0.275	2912
65	90	20	0.6	2913	47500	129000	2300	3500	65.2	90	80	75	0.6	0.374	2913
70	95	20	0.6	2914	49000	140000	2200	3400	70.2	95	85	80	0.6	0.400	2914
75	100	20	0.6	2915	51000	151000	2200	3300	75.2	100	90	85	0.6	0.425	2915
80	110	22	0.6	2916	57000	171000	2000	3000	80.2	110	98	92	0.6	0.600	2916
85	115	22	0.6	2917	59000	184000	1900	2900	85.2	115	103	97	0.6	0.640	2917
90	120	22	0.6	2918	59500	190000	1900	2900	90.2	120	108	102	0.6	0.670	2918
95	130	25	0.6	2919	75500	236000	1700	2600	95.2	130	116	109	0.6	0.795	2919
100	135	25	0.6	2920	78000	253000	1700	2500	100.2	135	121	114	0.6	0.930	2920
105	140	25	0.6	2921	78500	262000	1600	2500	105.2	140	126	119	0.6	1.02	2921
110	145	25	0.6	2922	78000	262000	1600	2400	110.2	145	131	124	0.6	1.15	2922
115	150	25	0.6	2923	73500	245000	1600	2400	115.2	150	136	129	0.6	1.25	2923
120	160	27	0.6	2924	94000	314000	1500	2200	120.2	160	144	136	0.6	1.35	2924
125	165	27	0.6	2925	85500	298000	1400	2200	125.3	165	149	141	0.6	1.48	2925
140	185	31	0.6	2928	106000	375000	1300	1900	140.3	185	167	158	0.6	2.33	2928

Single-direction Thrust Ball Bearings
Series 3900

Bore Diameter: 25~120mm

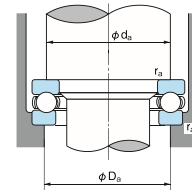
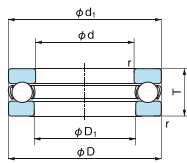

1N=0.102kgf

Boundary dimensions (mm)				Bearing No.	Basic dynamic load rating Ca (N)	Basic static load rating Coa (N)	Limiting speed (min ⁻¹)		Dimensions (mm)		Abutment and fillet dimensions (mm)			Mass (kg) Reference	Bearing No.
d	D	T	r (min)				Grease lubrication	Oil lubrication	D ₁ (min)	d ₁ (max)	da (min)	Da (max)	ra (max)		
25	52	16	1	3905	27100	50500	3400	5200	25.2	52	42	36	1.0	0.147	3905
30	60	19	1	3906	38000	72500	2900	4400	30.2	60	49	43	1.0	0.237	3906
35	68	22	1	3907	50500	99000	2500	3800	35.2	68	56.5	48.5	1.0	0.346	3907
40	76	25	1	3908	61000	119000	2200	3400	40.2	76	63	55	1.0	0.486	3908
45	85	28	1	3909	79500	163000	2000	3000	45.2	85	71	61	1.0	0.684	3909
50	92	31	1	3910	97000	202000	1800	2800	50.2	92	77	67	1.0	0.889	3910
55	100	33	1	3911	110000	240000	1700	2600	55.2	100	83.5	73.5	1.0	1.114	3911
60	106	35	1.5	3912	119000	263000	1600	2400	60.2	106	89	79	1.5	1.293	3912
65	112	36	1.5	3913	128000	287000	1500	2300	65.2	112	95.5	83.5	1.5	1.443	3913
70	120	38	1.5	3914	143000	335000	1400	2200	70.2	120	102	90	1.5	1.767	3914
75	128	41	1.5	3915	159000	365000	1300	2000	75.2	128	108.5	96.5	1.5	2.132	3915
80	136	44	1.5	3916	183000	425000	1200	1900	80.2	136	115	101	1.5	2.606	3916
85	145	47	1.5	3917	207000	490000	1100	1700	85.2	145	122	108	1.5	3.157	3917
90	155	50	1.5	3918	232000	555000	1100	1600	90.2	155	131	115	1.5	3.907	3918
95	165	54	1.5	3919	253000	630000	1000	1500	95.2	165	139	123	1.5	4.810	3919
100	172	57	1.5	3920	250000	630000	980	1400	100.2	172	144	128	1.5	5.454	3920
105	180	60	2.5	3921	257000	670000	930	1400	105.2	180	153	137	2.5	6.354	3921
110	190	63	2.5	3922	293000	785000	880	1300	110.2	190	159	141	2.5	7.333	3922
115	200	66	2.5	3923	315000	870000	840	1200	115.2	200	167.5	147.5	2.5	8.526	3923
120	210	69	2.5	3924	325000	930000	800	1200	120.2	210	178	158	2.5	10.195	3924

Single-direction Thrust Ball Bearings
Inch Series
Series O

Bore Diameter: 9.525~152.400mm

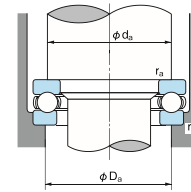
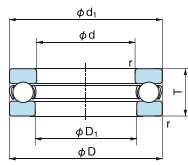

1N=0.102kgf

Boundary dimensions (mm)				Bearing No.	Basic dynamic load rating Ca (N)	Basic static load rating Coa (N)	Limiting speed (min ⁻¹)		Dimensions (mm)		Abutment and fillet dimensions (mm)			Mass (kg) Reference	Bearing No.
d	D	T	r (min)				Grease lubrication	Oil lubrication	D ₁ (min)	d ₁ (max)	d _a (min)	D _a (max)	r _a (max)		
9.525	25.400	13.494	0.8	O - 3	11800	15200	5400	8100	9.925	24.606	19.1	15.9	0.8	0.036	O - 3
12.700	32.544	15.875	0.8	O - 4	18600	25100	4300	6500	13.097	31.750	24.6	20.6	0.8	0.077	O - 4
15.875	35.719	15.875	0.8	O - 5	19400	28300	4100	6200	16.272	34.925	27.8	23.8	0.8	0.086	O - 5
19.050	38.894	15.875	0.8	O - 6	21400	34500	4000	6000	19.447	38.100	29	26	0.8	0.095	O - 6
22.225	42.069	15.875	0.8	O - 7	21900	37500	3800	5800	22.622	41.275	34	30	0.8	0.100	O - 7
25.400	45.244	15.875	1.6	O - 8	22500	41000	3700	5500	25.797	44.450	37	33	0.8	0.110	O - 8
28.575	48.419	15.875	1.6	O - 9	24100	47000	3600	5400	28.972	47.625	40	37	0.8	0.128	O - 9
31.750	53.181	18.256	1.6	O -10	27900	54500	3200	4800	32.147	52.388	45	40	0.8	0.164	O -10
34.925	56.356	18.256	1.6	O -11	28600	58000	3100	4600	35.322	55.562	48	43	0.8	0.186	O -11
38.100	59.531	18.256	1.6	O -12	30500	66000	3000	4500	38.497	58.738	51	47	1	0.200	O -12
41.275	62.706	18.256	1.6	O -13	26700	63000	2900	4400	41.672	61.912	54	50	1	0.210	O -13
44.450	68.262	19.050	1.6	O -14	32500	77500	2700	4100	44.847	67.469	59	54	1	0.260	O -14
47.625	71.438	19.050	1.6	O -15	37500	89000	2700	4000	48.021	70.644	62	57	1	0.285	O -15
50.800	75.406	19.050	2.4	O -16	38000	94000	2600	3900	51.594	74.613	66	61	1	0.300	O -16
53.975	81.756	22.225	2.4	O -17	49500	118000	2300	3500	54.769	80.962	71	65	1.6	0.405	O -17
57.150	84.931	22.225	2.4	O -18	50500	125000	2300	3400	57.944	84.138	74	68	1.6	0.450	O -18
60.325	91.281	25.400	2.4	O -19	58000	145000	2000	3100	61.119	90.488	79	73	1.6	0.590	O -19
63.500	94.456	25.400	2.4	O -20	59500	152000	2000	3000	64.294	93.662	82	76	1.6	0.610	O -20
66.675	97.631	25.400	2.4	O -21	60500	160000	2000	3000	67.469	96.838	85	79	1.6	0.660	O -21
69.850	102.394	25.400	2.4	O -22	71500	179000	1900	2900	70.644	101.600	89	83	1.6	0.700	O -22
73.025	105.569	25.400	2.4	O -23	75500	199000	1900	2800	73.819	104.775	93	86	1.6	0.730	O -23
76.200	111.125	28.575	3.2	O -24	77000	209000	1700	2600	77.788	109.538	97	90	2	0.900	O -24
82.550	122.238	31.750	3.2	O -26	97500	252000	1600	2400	84.138	120.650	106	98	2	1.30	O -26
88.900	128.588	31.750	3.2	O -28	99000	266000	1500	2300	90.488	127.000	113	105	2	1.32	O -28
95.250	134.938	31.750	3.2	O -30	98500	289000	1500	2200	96.838	133.350	119	111	2	1.36	O -30
101.600	147.638	34.925	3.2	O -32	113000	310000	1300	2000	103.188	146.050	129	120	2	1.88	O -32
114.300	166.888	44.450	4.8	O -36	157000	435000	1100	1700	115.888	165.100	146	135	3	3.18	O -36
127.000	185.738	50.800	4.8	O -40	193000	545000	1000	1500	128.588	184.150	162	150	3	4.54	O -40
139.700	204.788	55.562	4.8	O -44	248000	715000	910	1300	141.288	203.200	179	166	3	5.90	O -44
152.400	220.662	60.325	4.8	O -48	269000	805000	830	1200	153.988	219.075	193	180	3	7.25	O -48

Extra Small and Miniature Thrust Ball Bearings
TAM Type

Bore Diameter: 3~8mm

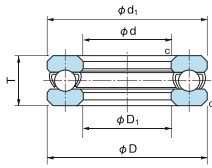

1N=0.102kgf

Boundary dimensions (mm)						Bearing No.	Basic dynamic load rating C_a (N)	Basic static load rating C_{0a} (N)	Mass (kg) Reference
d	D	T	c	D ₁	d ₁				
3	8	3.5	0.2	3.2	8	3TAM8	1790	1720	0.6
4	9	4	0.2	4.1	9	4TAM9	1860	1970	0.8
5	10	4	0.3	5.1	10	5TAM10	1930	2220	0.9
6	12	4.5	0.3	6.2	12	6TAM12	1820	2220	1.7
7	14	4.5	0.3	7.2	14	7TAM14	2480	3140	2.3
8	16	5	0.3	8.2	16	8TAM16	3920	4990	3.4

Extra Small and Miniature Thrust Ball Bearings
TG Type (Banded)

Bore Diameter: 5~8mm

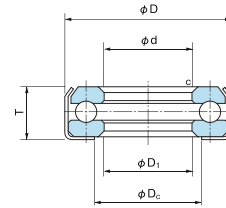

1N=0.102kgf

Boundary dimensions (mm)						Bearing No.	Basic dynamic load rating C_a (N)	Basic static load rating C_{0a} (N)	Mass (kg) Reference
d	D	T	c	D ₁	D _c				
5	10	4.2	0.3	5.1	5.8	5TG-10	2200	2710	1.3
6	12	4.7	0.5	6.2	7.2	6TG-12	2450	3450	2.2
7	14	4.7	0.5	7.2	8.2	7TG-14	3320	4890	3.0
8	16	5.2	0.5	8.2	9.2	8TG-16	4750	6650	4.0

Double-direction Thrust Ball Bearings

Bore Diameter: 15~75mm

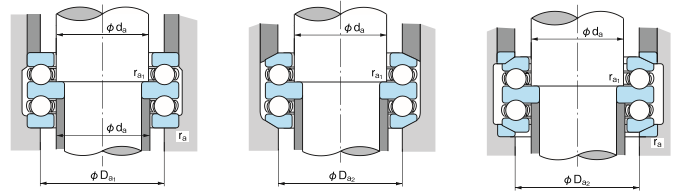
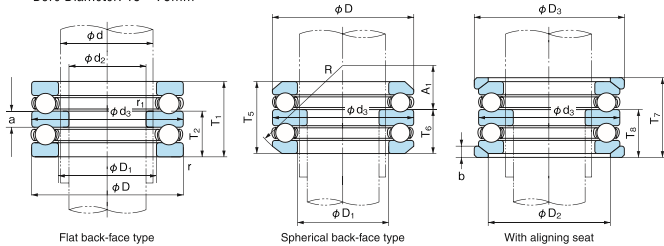

1N=0.102kgf

Boundary dimensions (mm)						Bearing No.			Basic dynamic load rating Ca (N)	Basic static load rating Co (N)	Limiting speed (min ⁻¹)		Dimensions (mm)										Abutment and fillet dimensions (mm)					Mass (kg) Reference			Bearing No.			
d	d2	D	T1	T2	T3	r (min)	r1 (min)	Flat back-face type			Spherical back-face type	With aligning seat	Grease lubrication	Oil lubrication	d3 (max)	D1 (min)	D2	D3	T2	T3	T4	a	b	A1	R	d4 (min)	D4 (max)	D5 (max)	r4 (max)	r5 (max)		Flat back-face type	Spherical back-face type	With aligning seat
15	10	32	22	24.6	28	0.6	0.3	52202	54202	54202U	16600	24900	5100	7600	32	17	24	35	13.5	14.8	16.5	5	4	10.5	28	15	22	24	0.6	0.3	0.085	0.090	0.116	52202
20	15	40	26	27.4	32	0.6	0.3	52204	54204	54204U	22200	37500	4200	6300	40	22	30	42	16	16.7	19	6	5	16	36	20	28	30	0.6	0.3	0.150	0.147	0.189	52204
25	20	47	28	31.4	36	0.6	0.3	52205	54205	54205U	27800	50500	3700	5600	47	27	36	50	17.5	19.2	21.5	7	5.5	16.5	40	25	34	36	0.6	0.3	0.230	0.241	0.305	52205
	15	60	45	49.8	55	1	0.6	52305	54305	54305U	35500	61500	3200	4900	52	27	38	55	21	22.8	25	8	6	18	45	25	36	38	1	0.3	0.330	0.340	0.431	52305
	25	60	45	49.8	55	1	0.6	52405	54405	54405U	55500	89500	2600	3900	60	27	42	62	28	30.4	33	11	8	15	50	25	39	42	1	0.6	0.630	0.650	0.796	52405
30	25	52	29	32.6	37	0.6	0.3	52206	54206	54206U	29300	58000	3400	5200	52	32	42	55	18	19.8	22	7	5.5	20	45	30	39	42	0.6	0.3	0.272	0.291	0.356	52206
	25	60	38	41.2	46	1	0.3	52306	54306	54306U	42500	78500	2800	4200	60	32	45	62	23.5	25.1	27.5	9	7	19.5	50	30	42	45	1	0.3	0.490	0.495	0.607	52306
	20	70	52	56.2	62	1	0.6	52406	54406	54406U	72500	126000	2200	3300	70	32	50	75	32	34.1	37	12	9	16	56	30	46	50	1	0.6	1.00	1.00	1.26	52406
35	30	62	34	37.8	42	1	0.3	52207	54207	54207U	39000	78000	2900	4400	62	37	48	65	21	22.9	25	8	7	21	50	35	46	48	1	0.3	0.420	0.431	0.550	52207
	30	68	44	47.2	52	1	0.3	52307	54307	54307U	55500	105000	2400	3700	68	37	52	72	27	28.6	31	10	7.5	21	56	35	48	52	1	0.3	0.710	0.711	0.881	52307
	25	80	59	63	69	1.1	0.6	52407	54407	54407U	87000	155000	1900	2900	80	37	58	85	36.5	38.5	41.5	14	10	18.5	64	35	53	58	1	0.6	1.44	1.43	1.78	52407
40	30	68	36	38.6	44	1	0.6	52208	54208	54208U	47000	98500	2700	4100	68	42	55	72	22.5	23.8	26.5	9	7	25	56	40	51	55	1	0.6	0.540	0.542	0.686	52208
	30	78	49	54	59	1	0.6	52308	54308	54308U	69000	135000	2200	3300	78	42	60	82	30.5	33	35.5	12	8.5	23.5	64	40	55	60	1	0.6	1.06	1.10	1.33	52308
	30	90	65	69.4	77	1.1	0.6	52408	54408	54408U	112000	205000	1700	2600	90	42	65	95	40	42.2	46	15	12	22	72	40	60	65	1	0.6	2.03	2.00	2.52	52408
45	35	73	37	39.6	45	1	0.6	52209	54209	54209U	47500	105000	2600	3900	73	47	60	78	23	24.3	27	9	7.5	23	56	45	56	60	1	0.6	0.620	0.617	0.796	52209
	35	85	52	56.2	62	1	0.6	52309	54309	54309U	80000	163000	2000	3000	85	47	65	90	32	34.1	37	12	10	21	64	48	61	65	1	0.6	1.29	1.28	1.63	52309
	35	100	72	78.8	86	1.1	0.6	52409	54409	54409U	129000	243000	1600	2400	100	47	72	105	44.5	47.9	51.5	17	12.5	23.5	80	45	67	72	1	0.6	2.71	2.76	3.40	52409
50	40	78	39	42	47	1	0.6	52210	54210	54210U	48500	112000	2400	3600	78	52	62	82	24	25.5	28	9	7.5	30.5	64	50	61	62	1	0.6	0.71	0.697	0.899	52210
	40	95	58	64.6	70	1.1	0.6	52310	54310	54310U	96500	202000	1800	2700	95	52	72	100	36	39.3	42	14	11	23	72	50	68	72	1	0.6	1.86	1.92	2.37	52310
	40	110	78	83.2	92	1.5	0.6	52410	54410	54410U	148000	283000	1400	2100	110	52	80	115	48	50.6	55	18	14	30	90	50	74	80	1.5	0.6	3.56	3.52	4.36	52410
55	45	90	45	49.6	55	1	0.6	52211	54211	54211U	69500	159000	2100	3100	90	57	72	95	27.5	29.8	32.5	10	9	32.5	72	55	69	72	1	0.6	1.12	1.14	1.54	52211
	45	105	64	72.6	78	1.1	0.6	52311	54311	54311U	120000	246000	1600	2400	105	57	80	110	39.5	43.8	46.5	15	11.5	25.5	80	55	75	80	1	0.6	2.51	2.65	3.22	52311
	45	120	87	92	101	1.5	0.6	52411	54411	54411U	178000	360000	1300	1900	120	57	88	125	53.5	56	60.5	20	15.5	22.5	90	55	81	88	1.5	0.6	4.70	4.55	5.64	52411
60	50	95	46	50	56	1	0.6	52212	54212	54212U	73500	179000	2000	3000	95	62	78	100	28	30	33	10	9	30.5	72	60	74	78	1	0.6	1.25	1.26	1.59	52212
	50	110	64	70.6	78	1.1	0.6	52312	54312	54312U	123000	267000	1600	2400	110	62	85	115	39.5	42.8	46.5	15	11.5	36.5	90	60	80	85	1	0.6	2.68	2.76	3.39	52312
	50	130	93	99	107	1.5	0.6	52412	54412	54412U	213000	435000	1200	1800	130	62	95	135	57	60	64	21	16	28	100	60	88	95	1.5	0.6	6.33	6.20	7.45	52412
65	55	100	47	50.4	57	1	0.6	52213	54213	54213U	75000	189000	1900	2800	100	67	82	105	28.5	30.2	33.5	10	9	38.5	80	65	79	82	1	0.6	1.36	1.35	1.72	52213
	55	115	65	71.8	79	1.1	0.6	52313	54313	54313U	127000	287000	1500	2300	115	67	90	120	40	43.4	47	15	12.5	34.5	90	65	85	90	1	0.6	2.90	2.98	3.67	52313
	50	140	101	109.4	119	2	1	52413	54413	54413U	231000	485000	1100	1600	140	68	100	145	62	66.2	71	23	17.5	34	112	65	95	100	2	1	8.03	8.01	9.67	52413
70	55	105	47	50.6	57	1	1	52214	54214	54214U	76000	199000	1800	2800	105	72	88	110	28.5	30.3	33.5	10	9	36.5	80	70	84	88	1	1	1.48	1.48	1.86	52214
	55	125	72	80.4	88	1.1	1	52314	54314	54314U	148000	340000	1400	2100	125	72	98	130	44	48.2	52	16	13	39	100	70	92	98	1	1	3.90	4.08	4.92	52314
	55	150	107	114.2	125	2	1	52414	54414	54414U	250000	555000	1000	1500	150	73	110	155	65.5	69.1	74.5	24	19.5	28.5	112	70	102	110	2	1	9.71	9.50	11.5	52414
75	60	110	47	49.6	57	1	1	52215	54215	54215U	77500	209000	1800	2700	110	77	92	115	28.5	29.8	33.5	10	9.5	47.5	90	75	89	92	1	1	1.57	1.53	1.96	52215
	60	135	79	87.2	95	1.5	1	52315	54315	54315U	170000	395000	1200	1900	135	77	105	140	48.5	52.6	56.5	18	15	32.5	100	75	99	105	1.5	1	4.83	4.93	6.04	52315
	60	160	115	123	135	2	1	52415	54415	54415U	252000	560000	950	1400	160	78	115	165	70.5	74.5	80.5	26	21	36.5	125	75	109	115	2	1	11.8	11.6	14.1	52415

Double-direction Thrust Ball Bearings

Bore Diameter: 80~170mm

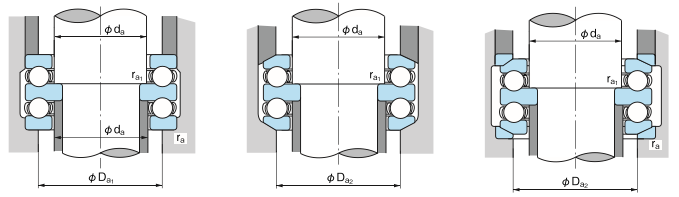
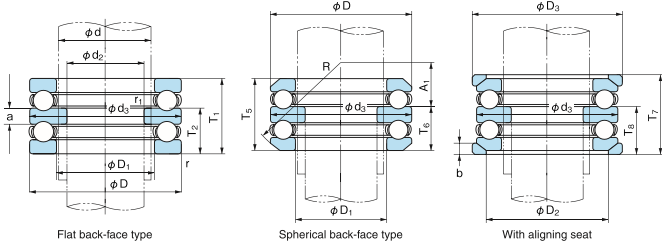

1N=0.102kgf

d	Boundary dimensions (mm)							Bearing No.			Basic dynamic load rating Ca (N)	Basic static load rating Co (N)	Limiting speed (min ⁻¹)		Dimensions (mm)										Abutment and fillet dimensions (mm)			Mass (kg) Reference			Bearing No.			
	d ₂	D	T ₁	T ₅	T ₇	r (min)	r ₁ (min)	Flat back-face type	Spherical back-face type	With aligning seat			Grease lubrication	Oil lubrication	d ₃ (max)	D ₁ (min)	D ₂	D ₃	T ₂	T ₆	T ₈	a	b	A ₁	R	d _a (min)	D _{a1} (max)	D _{a2} (max)	r _a (max)	r _{a1} (max)		Flat back-face type	Spherical back-face type	With aligning seat
80	65	115	48	51	58	1	1	52216	54216	54216U	78500	219000	1700	2600	115	82	98	120	29	30.5	34	10	10	45	90	80	94	98	1	1	1.69	1.67	2.11	52216
	65	140	79	86.2	95	1.5	1	52316	54316	54316U	176000	425000	1200	1800	140	82	110	145	48.5	52.1	56.5	18	15	45.5	112	80	104	110	1.5	1	5.06	5.14	6.29	52316
	65	170	120	128.4	140	2.1	1	52416	54416	54416U	270000	620000	900	1300	170	83	125	175	73.5	77.7	83.5	27	22	30.5	125	80	116	125	2	1	14.0	13.7	16.5	52416
85	70	125	55	59.2	67	1	1	52217	54217	54217U	95500	264000	1600	2400	125	88	105	130	33.5	35.6	39.5	12	11	49.5	100	85	101	105	1	1	2.34	2.34	2.93	52217
	70	150	87	95.2	105	1.5	1	52317	54317	54317U	206000	490000	1100	1700	150	88	115	155	53	57.1	62	19	17.5	39	112	85	111	115	1.5	1	6.43	6.41	8.05	52317
	65	180	128	138	150	2.1	1.1	52417	54417	54417U	288000	685000	850	1200	179.5	88	130	185	78.5	83.5	89.5	29	23	40.5	140	85	123	130	2	1	17.5	17.3	20.7	52417
90	75	135	62	69	76	1.1	1	52218	54218	54218U	116000	325000	1400	2100	135	93	110	140	38	41.5	45	14	13.5	42	100	90	108	110	1	1	3.22	3.25	4.12	52218
	75	155	88	97.2	106	1.5	1	52318	54318	54318U	213000	525000	1100	1600	155	93	120	160	53.5	58.1	62.5	19	18	36.5	112	90	116	120	1.5	1	6.60	6.62	8.33	52318
	70	190	135	143.4	157	2.1	1.1	52418	54418	54418U	305000	750000	790	1100	189.5	93	140	195	82.5	86.7	93.5	30	25.5	34.5	140	90	130	140	2	1	19.6	19.1	23.0	52418
100	85	150	67	72.8	81	1.1	1	52220	54220	54220U	146000	410000	1300	1900	150	103	125	155	41	43.9	48	15	14	49	112	100	120	125	1	1	4.29	4.29	5.32	52220
	85	170	97	105.4	115	1.5	1	52320	54320	54320U	236000	595000	1000	1500	170	103	135	175	59	63.2	68	21	18	42	125	100	128	135	1.5	1	8.90	8.92	10.8	52320
	80	210	150	160	176	3	1.1	52420	54420	54420U	345000	895000	710	1000	209.5	103	155	220	91.5	96.5	104.5	33	27	43.5	160	100	144	155	2.5	1	26.6	26.2	32.0	52420
110	95	160	67	71.4	81	1.1	1	52222	54222	54222U	153000	450000	1200	1900	160	113	135	165	41	43.2	48	15	14	62	125	110	130	135	1	1	4.68	4.60	5.74	52222
	95	190	110	118.4	128	2	1	52322	54322	54322U	268000	705000	880	1300	189.5	113	150	195	67	71.2	76	24	20.5	47	140	110	142	150	2	1	13.8	13.7	16.3	52322
	90	230	166	—	—	3	1.1	52422	—	—	435000	1240000	640	960	229	113	—	—	101.5	—	—	37	—	—	—	110	158	—	2.5	1	34.9	—	—	52422
120	100	170	68	71.6	82	1.1	1.1	52224	54224	54224U	152000	470000	1200	1800	170	123	145	175	41.5	43.3	48.5	15	15	58.5	125	120	140	145	1	1	5.24	5.04	6.36	52224
	100	210	123	131.2	143	2.1	1.1	52324	54324	54324U	267000	870000	790	1100	209.5	123	165	220	75	79.1	85	27	22	58	160	120	156	165	2	1	17.2	16.9	21.0	52324
	95	250	177	—	—	4	1.5	52424	—	—	455000	1340000	580	880	249	123	—	—	108.5	—	—	40	—	—	—	120	172	—	3	1.5	44.2	—	—	52424
130	110	190	80	85.8	96	1.5	1.1	52226	54226	54226U	203000	620000	1000	1500	189.5	133	160	195	49	51.9	57	18	17	63	140	130	154	160	1.5	1	7.72	7.58	9.43	52226
	110	225	130	—	—	2.1	1.1	52326	—	—	330000	960000	730	1100	224	134	—	—	80	—	—	30	—	—	—	130	168	—	2	1	22.1	—	—	52326
	100	270	192	—	—	4	2	52426	—	—	555000	1750000	540	810	269	134	—	—	117	—	—	42	—	—	—	130	186	—	3	2	56.5	—	—	52426
140	120	200	81	86.2	99	1.5	1.1	52228	54228	54228U	205000	650000	1000	1500	199.5	143	170	210	49.5	52.1	58.5	18	17	83.5	160	140	164	170	1.5	1	8.93	8.79	11.3	52228
	120	240	140	—	—	2.1	1.1	52328	—	—	350000	1050000	680	1000	239	144	—	—	85.5	—	—	31	—	—	—	140	180	—	2	1	27.8	—	—	52328
	110	280	196	—	—	4	2	52428	—	—	545000	1750000	520	780	279	144	—	—	120	—	—	44	—	—	—	140	196	—	3	2	60.6	—	—	52428
150	130	215	89	95.6	109	1.5	1.1	52230	54230	54230U	213000	650000	940	1400	214.5	153	180	225	54.5	57.8	64.5	20	20.5	74.5	160	150	176	180	1.5	1	10.6	10.3	13.8	52230
	130	250	140	—	—	2.1	1.1	52330	—	—	360000	1130000	670	1000	249	154	—	—	85.5	—	—	31	—	—	—	150	190	—	2	1	29.2	—	—	52330
	120	300	209	—	—	4	2	52430	—	—	615000	2010000	480	720	299	153	—	—	127.5	—	—	46	—	—	—	150	210	—	3	2	73.9	—	—	52430
160	140	225	90	97.4	110	1.5	1.1	52232	54232	54232U	223000	720000	900	1300	224.5	163	190	235	55	58.7	65	20	21	70	160	160	186	190	1.5	1	12.2	11.9	15.6	52232
	140	270	153	—	—	3	1.1	52332	—	—	410000	1340000	610	820	269	164	—	—	93	—	—	33	—	—	—	160	204	—	2.5	1	37.7	—	—	52332
	130	320	226	—	—	5	2	52432	—	—	680000	2410000	440	670	319	164	—	—	138	—	—	50	—	—	—	160	224	—	4	2	90.3	—	—	52432
170	150	240	97	104.4	117	1.5	1.1	52234	54234	54234U	261000	835000	840	1200	239.5	173	200	250	59	62.7	69	21	21.5	87	180	170	198	200	1.5	1	15.2	14.7	19.1	52234
	150	280	153	—	—	3	1.1	52334	—	—	420000	1430000	600	900	279	174	—	—	93	—	—	33	—	—	—	170	214	—	2.5	1	39.8	—	—	52334
	135	340	236	—	—	5	2.1	52434	—	—	755000	2730000	420	630	339	174	—	—	143	—	—	50	—	—	—	170	238	—	4	2	108	—	—	52434

Double-direction Thrust Ball Bearings

Bore Diameter: 180~220mm

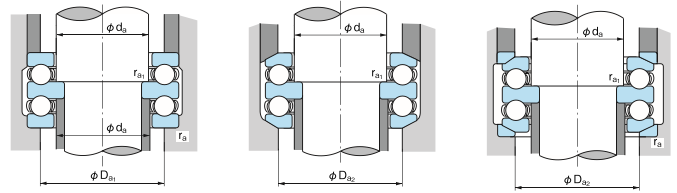
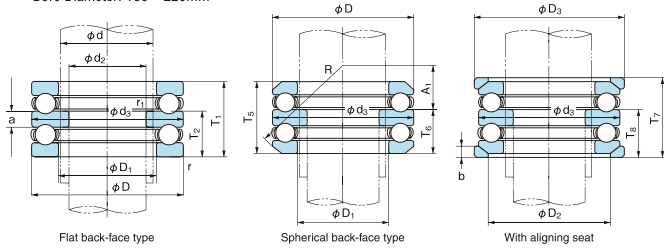

1N=0.102kgf

Boundary dimensions (mm)										Bearing No.			Basic dynamic load rating Ca (N)	Basic static load rating Coa (N)	Limiting speed (min ⁻¹)		Dimensions (mm)										Abutment and fillet dimensions (mm)					Mass (kg) Reference			Bearing No.
d	d2	D	T1	Ts	T7	r	r1	Flat back-face type	Spherical back-face type	With aligning seat	Grease lubrication	Oil lubrication			d3 (max)	D1 (min)	D2	D3	T2	T6	T8	a	b	A1	R	d3 (min)	D31 (max)	D32 (max)	r3 (max)	r31 (max)	Flat back-face type	Spherical back-face type	With aligning seat	16.0	
180	150	250	98	102.4	118	1.5	2	52236	54236	54236U	266000	875000	810	1200	249	183	210	260	59.5	61.7	69.5	21	21.5	108.5	200	180	208	210	1.5	2	16.0	15.2	19.9	52236	
	150	300	165	—	—	3	2	52336	—	—	485000	1700000	550	820	299	184	—	101	—	37	—	—	—	—	180	228	—	2.5	2	50.9	—	—	—	52336	
	140	360	245	—	—	5	3	52436	—	—	785000	2980000	400	600	359	184	—	148.5	—	52	—	—	—	—	180	252	—	4	2.5	126	—	—	—	52436	
190	160	270	109	116.4	131	2	2	52238	54238	54238U	310000	1060000	740	1100	269	194	230	280	66.5	70.2	77.5	24	23	93.5	200	190	222	230	2	2	21.6	21.2	26.5	52238	
	160	320	183	—	—	4	2	52338	—	—	570000	2100000	500	750	319	195	—	111.5	—	40	—	—	—	—	190	242	—	3	2	64.9	—	—	—	52338	
200	170	280	109	115.6	133	2	2	52240	54240	54240U	315000	1110000	720	1000	279	204	240	290	66.5	69.8	78.5	24	23	120.5	225	200	232	240	2	2	22.7	22.3	28.0	52240	
	170	340	192	—	—	4	2	52340	—	—	625000	2380000	470	710	339	205	—	117	—	42	—	—	—	—	200	256	—	3	2	77.8	—	—	—	52340	
220	190	300	110	115.2	134	2	2	52244	54244	54244U	325000	1210000	690	1000	299	224	260	310	67	69.6	79	24	25	114	225	220	252	260	2	2	23.9	22.9	29.6	52244	



Spherical Roller Thrust Bearings

Tolerance Page 52
 Preload Page 95

Because there are many sliding surfaces in Spherical Roller Thrust Bearings (cage-to-guide-sleeve and roller-ends-to-rib), oil lubricant (not grease) should be used.

● **Aligning angle**

Maximum permissible misalignment angle is about 2° under general service conditions. If the aligning advantages of this bearing type are to be realized, care must be taken to provide clearance for parts in the surrounding structure.

● **Minimum axial load**

To prevent damage caused by sliding motion between the rollers and raceway, spherical roller thrust bearings must be subjected to a load more than the minimum load, $F_{a \text{ min}}$.

$$F_{a \text{ min}} = \frac{C_{0a}}{1000}$$

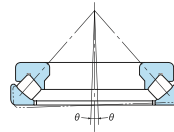

- The safety-factor "S₀" must be over 4.



Spherical Roller Thrust Bearings

Bore Diameter: 60~130mm

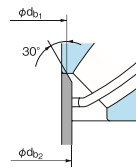
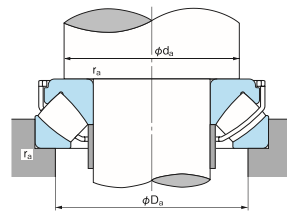
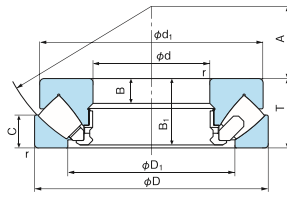
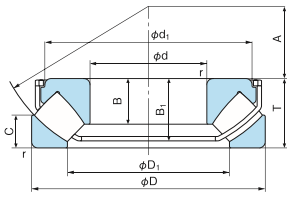

■ **Dynamic equivalent axial load**
 $F_a = F_a + 1.2F_r$
 ■ **Static equivalent axial load**
 $P_{0a} = F_a + 2.7F_r$
 where, F_a : Axial load
 F_r : Radial load
 However $\frac{F_r}{F_a} \leq 0.55$
 However $F_r/F_a \leq 0.55$ must be satisfied

1N=0.102kgf

Boundary dimensions (mm)				Bearing No.	Basic dynamic load rating C_a (N)	Basic static load rating C_{0a} (N)	Limiting speed (min^{-1})		Reference Dimensions (mm)						Abutment and fillet dimensions (mm)			Spacer dimensions (mm)		Mass (kg) (Reference)	Bearing No.
d	D	T	r (min)				Grease lubrication	Oil lubrication	d_1	D_1	B	B_1	C	A	d_a (min)	D_a (max)	r_a (max)	db_1 (max)	db_2 (max)		
60	130	42	1.5	29412E	299000	890000	—	2800	123	89	15	39.5	20	38	91	108	1.5	—	—	2.75	29412E
	130	42	1.5	29412EX	350000	915000	1800	2800	113	87	27	37.1	20	38	91	108	1.5	66.0	66.0	2.50	29412EX
65	140	45	2	29413E	345000	1040000	—	2700	133	96	16	42.5	21	42	99	115	2.0	—	—	3.41	29413E
	140	45	2	29413EX	410000	1110000	1700	2700	123	93.5	29.5	40	21	42	99	115	2.0	72.0	72.0	3.20	29413EX
70	150	48	2	29414E	375000	1110000	—	2400	142	103	17	45.5	23	44	106	125	2.0	—	—	4.16	29414E
	150	48	2	29414EX	490000	1350000	1600	2400	128.3	98.4	32	42.7	23	44	106	125	2.0	75.5	77.5	3.82	29414EX
75	160	51	2	29415E	445000	1380000	—	2300	152	109	18	48	24	47	113	132	2.0	—	—	4.98	29415E
	160	51	2	29415EX	525000	1470000	1600	2300	140	105.6	34.5	45.6	24	47	113	132	2.0	82.5	82.5	4.70	29415EX
80	170	54	2.1	29416E	480000	1490000	—	2100	162	117	19	51	26	50	120	140	2.0	—	—	5.95	29416E
	170	54	2.1	29416EX	580000	1630000	1500	2100	149	113	36	48.2	26	50	120	140	2.0	88.0	88.0	5.60	29416EX
85	150	39	1.5	29317E	293000	990000	—	2700	143.5	114	13	37	19	50	115	135	1.5	—	—	2.87	29317E
	150	39	1.5	29317EX	365000	1060000	1600	2700	134	110.5	25	35	19	50	115	135	1.5	90.0	90.0	2.67	29317EX
	180	58	2.1	29417E	540000	1720000	—	2000	170	125	21	55	28	54	130	150	2.0	—	—	7.19	29417E
	180	58	2.1	29417EX	640000	1810000	1300	2000	158.2	120.5	37	50.6	28	54	130	150	2.0	94.0	94.0	6.69	29417EX
90	155	39	1.5	29318E	300000	1040000	—	2700	148.5	117	13	37	19	52	120	140	1.5	—	—	3.06	29318E
	155	39	1.5	29318EX	355000	1070000	1600	2700	135.2	116	23.8	35.1	19	52	120	140	1.5	95.0	95.0	2.75	29318EX
	190	60	2.1	29418E	620000	2020000	—	1900	180	132	22	57	29	56	135	157	2.0	—	—	8.28	29418E
	190	60	2.1	29418EX	710000	2080000	1300	1900	162	127	40.5	53	29	56	135	157	2.0	99.0	99.0	7.83	29418EX
100	170	42	1.5	29320E	355000	1260000	—	2500	163	129	14	40	20.8	58	130	150	1.5	—	—	3.91	29320E
	170	42	1.5	29320EX	435000	1400000	1500	2500	146.9	126	27	38.2	20.8	58	130	150	1.5	105.0	107.0	3.61	29320EX
	210	67	3	29420E	690000	2230000	—	1700	200	146	24	64	32	62	150	175	2.5	—	—	11.2	29420E
	210	67	3	29420EX	870000	2530000	1100	1700	181	139	44.5	59.6	32	62	150	175	2.5	108.0	110.0	10.6	29420EX
110	190	48	2	29322E	470000	1680000	—	2100	182	143	16	45.5	23	64	145	165	2.0	—	—	5.67	29322E
	190	48	2	29322EX	550000	1730000	1300	2100	165.1	140.6	30.9	44	23	64	145	165	2.0	116.0	117.0	5.22	29322EX
	230	73	3	29422E	845000	2820000	—	1500	220	162	26	69	35	69	165	190	2.5	—	—	14.7	29422E
	230	73	3	29422EX	1060000	3150000	950	1500	199.6	153.4	48	64.4	35	69	165	190	2.5	119.5	120.0	14.0	29422EX
120	210	54	2.1	29324E	565000	2030000	—	1900	200	159	18	51	26	70	160	180	2.0	—	—	7.90	29324E
	210	54	2.1	29324EX	670000	2160000	1100	1900	184.5	155	34.5	48.7	26	70	160	180	2.0	127.0	128.0	7.30	29324EX
	250	78	4	29424E	1030000	3450000	—	1400	236	174	29	74	37	74	180	205	3.0	—	—	18.5	29424E
	250	78	4	29424EX	1210000	3750000	900	1400	218	166.5	54	70.9	37	74	180	205	3.0	131.0	132.0	17.6	29424EX
130	225	58	2.1	29326E	665000	2420000	—	1800	215	171	19	55	28	76	170	195	2.0	—	—	9.45	29326E
	225	58	2.1	29326EX	770000	2440000	1000	1800	197.4	165.8	36.8	52.7	28	76	170	195	2.0	136.0	138.0	8.82	29326EX
	270	85	4	29426E	1140000	3850000	—	1200	255	189	31	81	41	81	195	225	3.0	—	—	23.5	29426E
	270	85	4	29426EX	1400000	4300000	850	1200	236.4	181	56	75	41	81	195	225	3.0	141.5	143.0	22.3	29426EX

Note: For heavy load application, d_a should be large enough to support the shaft washer rib.

Spherical Roller Thrust Bearings

Bore Diameter: 140~240mm

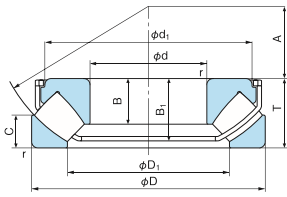

Type EX

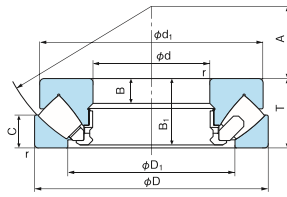

Type E

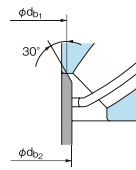
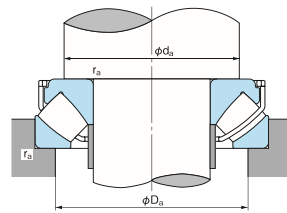

Dynamic equivalent axial load
 $F_a = F_r \cdot 1.2F_r$
Static equivalent axial load
 $P_{0a} = F_a + 2.7F_r$
 where, F_a : Axial load
 F_r : Radial load
 However $\frac{F_r}{F_a} \leq 0.55$
 However $F_r/F_a \leq 0.55$ must be satisfied

1N=0.102kgf

Boundary dimensions (mm)				Bearing No.	Basic dynamic load rating C_a (N)	Basic static load rating C_{0a} (N)	Limiting speed (min ⁻¹)		Reference Dimensions (mm)						Abutment and fillet dimensions (mm)			Spacer dimensions (mm)		Mass (kg) (Reference)	Bearing No.
d	D	T	r (min)				Grease lubrication	Oil lubrication	d ₁	D ₁	B	B ₁	C	A	d _a (min)	D _a (max)	r _a (max)	db ₁ (max)	db ₂ (max)		
140	240	60	2.1	29328E	700000	2560000	—	1600	230	183	20	57	29	82	185	205	2.0	—	—	11.2	29328E
	240	60	2.1	29328EX	860000	2840000	950	1600	218.4	179	38.5	54.8	29	82	185	205	2.0	147.5	149.0	10.5	29328EX
	280	85	4	29428E	1200000	4050000	—	1200	268	199	31	81	41	86	205	235	3.0	—	—	24.6	29428E
	280	85	4	29428EX	1410000	4350000	850	1200	246	196	53.6	74.4	41	86	205	235	3.0	153.0	160.0	22.8	29428EX
150	215	39	1.5	29230E	335000	1390000	—	2100	208	178	14	37	19	82	179	196	1.5	—	—	4.60	29230E
	250	60	2.1	29330E	735000	2840000	—	1600	240	194	20	57	29	87	195	215	2.0	—	—	11.7	29330E
	300	90	4	29430E	1330000	4600000	—	1100	285	214	32	86	44	92	220	250	3.0	—	—	29.6	29430E
	300	90	4	29430EX	1630000	5150000	800	1100	265.4	207.5	58.5	80.8	44	92	220	250	3.0	163.0	169.0	27.8	29430EX
160	225	39	1.5	29232E	345000	1470000	—	2100	219	188	14	37	19	85	189	206	1.5	—	—	4.70	29232E
	270	67	3	29332E	880000	3400000	—	1400	260	208	23	64	32	92	210	235	2.5	—	—	15.5	29332E
	270	67	3	29332EX	1040000	3500000	850	1400	243.4	199.8	44	61.4	32	92	210	235	2.5	166.0	174.0	14.5	29332EX
	320	95	5	29432E	1510000	5350000	—	1000	306	229	34	91	45	99	230	265	4.0	—	—	35.9	29432E
320	95	5	29432EX	1820000	5750000	750	1000	283.8	222	62.5	85.7	45	99	230	265	4.0	174.5	181.0	33.4	29432EX	
170	240	42	1.5	29234E	390000	1700000	—	1900	233	198	15	40	20	92	201	218	1.5	—	—	6.00	29234E
	280	67	3	29334E	900000	3550000	—	1400	270	216	23	64	32	96	220	245	2.5	—	—	16.3	29334E
	340	103	5	29434E	1670000	5900000	—	950	324	243	37	99	50	104	245	285	4.0	—	—	44.0	29434E
180	250	42	1.5	29236E	420000	1900000	—	1900	243	208	15	40	21	95	211	228	1.5	—	—	6.30	29236E
	300	73	3	29336E	1020000	3950000	—	1300	290	232	25	69	35	103	235	260	2.5	—	—	20.7	29336E
	360	109	5	29436E	1950000	7000000	—	860	342	255	39	105	52	110	260	300	4.0	—	—	52.2	29436E
190	270	48	2	29238E	540000	2300000	—	1800	262	223	15	45	24	104	225	245	2.0	—	—	8.50	29238E
	320	78	4	29338E	1170000	4550000	—	1100	308	246	27	74	38	110	250	275	3.0	—	—	25.5	29338E
	380	115	5	29438E	2120000	7750000	—	800	360	271	41	111	55	117	275	320	4.0	—	—	61.4	29438E
200	280	48	2	29240E	550000	2410000	—	1800	271	236	15	45	24	108	235	255	2.0	—	—	9.08	29240E
	340	85	4	29340E	1350000	5250000	—	1000	325	261	29	81	41	116	265	295	3.0	—	—	32.0	29340E
	400	122	5	29440E	2350000	8450000	—	740	380	286	43	117	59	122	290	335	4.0	—	—	73.0	29440E
220	300	48	2	29244E	595000	2750000	—	1600	292	254	15	45	24	117	260	275	2.0	—	—	9.84	29244E
	360	85	4	29344E	1410000	5750000	—	1000	345	280	29	81	41	125	285	315	3.0	—	—	34.5	29344E
	420	122	6	29444E	2410000	8950000	—	720	400	308	43	117	58	132	310	355	5.0	—	—	74.2	29444E
240	340	60	2.1	29248E	890000	4000000	—	1300	330	283	19	57	30	130	285	305	2.0	—	—	17.1	29248E
	380	85	4	29348E	1410000	5850000	—	980	365	300	29	81	41	135	300	330	3.0	—	—	36.3	29348E
	440	122	6	29448E	2480000	9450000	—	720	420	326	43	117	59	142	330	375	5.0	—	—	83.0	29448E

Note: For heavy load application, d_a should be large enough to support the shaft washer.

Spherical Roller Thrust Bearings

Bore Diameter: 260~460mm

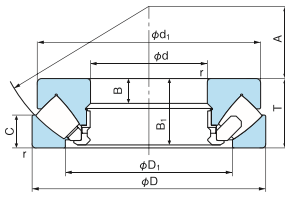

Type E

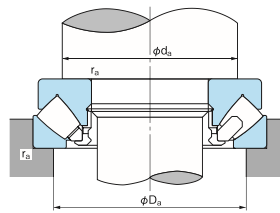

■ **Dynamic equivalent axial load**
 $F_a = F_a + 1.2F_r$
 ■ **Static equivalent axial load**
 $P_{oa} = F_a + 2.7F_r$
 where, F_a : Axial load
 F_r : Radial load
 However $\frac{F_r}{F_a} \leq 0.55$
 However $\frac{F_r}{F_a} \leq 0.55$ must be satisfied

1N=0.102kgf

Boundary dimensions (mm)				Bearing No.	Basic dynamic load rating C_a (N)	Basic static load rating C_{0a} (N)	Limiting speed (min ⁻¹)		Reference Dimensions (mm)						Abutment and fillet dimensions (mm)			Spacer dimensions (mm)		Mass (kg) (Reference)	Bearing No.
d	D	T	r (min)				Grease lubrication	Oil lubrication	d ₁	D ₁	B	B ₁	C	A	d _a (min)	D _a (max)	r _a (max)	db ₁ (max)	db ₂ (max)		
260	360	60	2.1	29252E	915000	4250000	—	1300	350	302	19	57	30	139	305	325	2.0	—	—	18.5	29252E
	420	95	5	29352E	1810000	7500000	—	860	405	329	32	91	45	148	330	365	4.0	—	—	51.5	29352E
	480	132	6	29452E	2940000	11600000	—	640	460	357	48	127	64	154	360	405	5.0	—	—	106	29452E
280	380	60	2.1	29256E	935000	4500000	—	1200	370	323	19	57	30	150	325	345	2.0	—	—	19.5	29256E
	440	95	5	29356E	1850000	7950000	—	840	423	348	32	91	46	158	350	390	4.0	—	—	54.0	29356E
	520	145	6	29456E	3450000	13500000	—	580	495	387	52	140	68	166	390	440	5.0	—	—	137	29456E
300	420	73	3	29260E	1220000	5850000	—	1000	405	353	21	69	38	162	355	380	2.5	—	—	31.0	29260E
	480	109	5	29360E	2310000	10000000	—	720	460	379	37	105	50	168	380	420	4.0	—	—	75.4	29360E
	540	145	6	29460E	3650000	14800000	—	540	515	402	52	140	70	175	410	460	5.0	—	—	146	29460E
320	440	73	3	29264E	1270000	6150000	—	980	430	372	21	69	38	172	375	400	2.5	—	—	32.8	29264E
	500	109	5	29364E	2370000	10600000	—	720	482	399	37	105	53	180	400	440	4.0	—	—	80.0	29364E
	580	155	7.5	29464E	4050000	16800000	—	480	555	435	55	149	75	191	435	495	6.0	—	—	179	29464E
340	460	73	3	29268E	1290000	6350000	—	950	445	395	21	69	37	183	395	420	2.5	—	—	34.5	29268E
	540	122	5	29368E	2850000	12400000	—	630	520	428	41	117	59	192	430	470	4.0	—	—	106	29368E
	620	170	7.5	29468E	4750000	19300000	—	430	590	462	61	164	82	201	465	530	6.0	—	—	228	29468E
360	500	85	4	29272E	1650000	8050000	—	830	485	423	25	81	44	194	420	455	3.0	—	—	50.4	29272E
	560	122	5	29372E	2900000	12900000	—	600	540	448	41	117	59	202	450	495	4.0	—	—	111	29372E
	640	170	7.5	29472E	4900000	20500000	—	410	610	480	61	164	82	210	485	550	6.0	—	—	234	29472E
380	520	85	4	29276E	1780000	8800000	—	800	505	441	27	81	42	202	440	475	3.0	—	—	52.8	29276E
	600	132	6	29376E	3400000	15300000	—	540	580	477	44	127	63	216	480	525	5.0	—	—	140	29376E
	670	175	7.5	29476E	5200000	22000000	—	400	640	504	63	168	85	230	510	575	6.0	—	—	263	29476E
400	540	85	4	29280E	1840000	9250000	—	800	526	460	27	81	42	212	460	490	3.0	—	—	55.1	29280E
	620	132	6	29380E	3550000	16300000	—	530	596	494	44	127	64	225	500	550	5.0	—	—	146	29380E
	710	185	7.5	29480E	5850000	25000000	—	360	680	534	67	178	89	236	540	610	6.0	—	—	314	29480E
420	580	95	5	29284E	2260000	11300000	—	700	564	489	30	91	46	225	490	525	4.0	—	—	74.9	29284E
	650	140	6	29384E	3900000	17900000	—	480	626	520	48	135	68	235	525	575	5.0	—	—	170	29384E
	730	185	7.5	29484E	6050000	26000000	—	360	700	556	67	178	89	244	560	630	6.0	—	—	325	29484E
440	600	95	5	29288E	2290000	11800000	—	660	585	508	30	91	49	235	510	545	4.0	—	—	79.0	29288E
	680	145	6	29388E	4050000	19000000	—	450	655	548	49	140	70	245	550	600	5.0	—	—	192	29388E
	780	206	9.5	29488E	6950000	30000000	—	300	745	588	74	199	100	260	595	670	8.0	—	—	421	29488E
460	620	95	5	29292E	2290000	11900000	—	660	605	530	30	91	46	245	530	570	4.0	—	—	80.9	29292E
	710	150	6	29392E	4600000	21700000	—	430	685	567	51	144	72	257	575	630	5.0	—	—	216	29392E
	800	206	9.5	29492E	7150000	31500000	—	290	765	608	74	199	100	272	615	690	8.0	—	—	435	29492E

Note: For heavy load application, d_s should be large enough to support the shaft washer rib.

Spherical Roller Thrust Bearings

Bore Diameter: 480~530mm

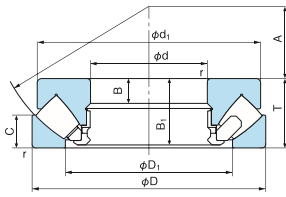

Type E

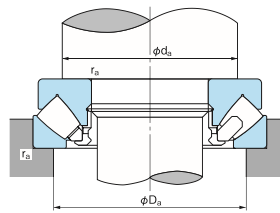

■ **Dynamic equivalent axial load**
 $F_a = F_r + 1.2F_r$
 ■ **Static equivalent axial load**
 $P_{0a} = F_a + 2.7F_r$
 where, F_a : Axial load
 F_r : Radial load
 However $\frac{F_r}{F_a} \leq 0.55$
 However $F_r/F_a \leq 0.55$ must be satisfied

1N=0.102kgf

Boundary dimensions (mm)				Bearing No.	Basic dynamic load rating C_a (N)	Basic static load rating C_{0a} (N)	Limiting speed (min ⁻¹)		Reference Dimensions (mm)						Abutment and fillet dimensions (mm)			Spacer dimensions (mm)		Mass (kg) (Reference)	Bearing No.
d	D	T	r (min)				Grease lubrication	Oil lubrication	d ₁	D ₁	B	B ₁	C	A	d _a (min)	D _a (max)	r _a (max)	db ₁ (max)	db ₂ (max)		
480	650	103	5	29296E	2530000	13200000	—	600	635	556	33	99	55	259	555	595	4.0	—	—	97.5	29296E
	730	150	6	29396E	4630000	21900000	—	410	705	590	51	144	72	270	595	650	5.0	—	—	224	29396E
	850	224	9.5	29496E	8250000	36000000	—	260	810	638	81	216	108	280	645	730	8.0	—	—	543	29496E
500	670	103	5	292/500E	2590000	13800000	—	600	654	574	33	99	55	268	575	615	4.0	—	—	101	292/500E
	750	150	6	293/500E	4700000	22600000	—	410	725	611	51	144	74	280	615	670	5.0	—	—	231	293/500E
	870	224	9.5	294/500E	8250000	35000000	—	250	830	661	81	216	107	290	670	750	8.0	—	—	559	294/500E
530	710	109	5	292/530E	2820000	15100000	—	540	692	612	35	105	57	288	615	653	4.0	—	—	106	292/530E

Note: For heavy load application, d_s should be large enough to support the shaft washer rib.



Precision Machine Tool Bearings

Bearings selected for use in machine tools are required to have a design which will ensure high rotational speed and high accuracy.

Bearings for Machine Tool Spindles

Spindle bearings are generally classified as those that support radial load and those that support thrust loads.

Angular Contact Ball Bearings		Double-direction Thrust Angular Contact Ball Bearings	
70, 70B, 70C 72, 72B, 72C See page 166	BNH000 See page 369	TAD20 See page 373	
Cylindrical Roller Bearings		Combination Angular Contact Ball Bearings	
NN30 NN30K See page 202	N10 N10K See page 202	TAH10T See page 375	TBH10T See page 376

Fig 1. The bearings for radial load

Fig 2. The bearings for axial load

**High-speed Angular Contact Ball Bearings
BNH000 Series**

(1) High-speed Angular Contact Ball Bearings - BNH000 Series

● Feature design

BNH000 Series bearings are designed with smaller balls than Angular Contact Ball Bearings Type C. They are suitable for high-speed applications and lower heat generation and are typically used in high speed machining center spindles. (Their tolerance class is JIS (ISO) class 4 normally.)

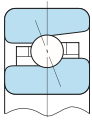

BNH000

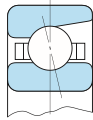

7000C

● Standard preload

Standard preload of BNH type is designed with light preload.

Bore Diameter Number	BNH000
07	78.5
08	
09	98.1
10	
11	
12	147
13	
14	
15	245
16	
17	294
18	
19	392
20	
21	490
22	
24	588
26	785
28	834
30	1080
32	1180
34	1370

Unit: N

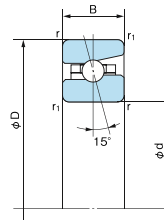

1N=0.102kgf

Bearing No.	Dimensions (mm)					Basic dynamic load rating Cr (N)	Basic static load rating Cor (N)	Limiting speed (min ⁻¹)	
	d	D	B	r (min)	r ₁ (min)			Grease lubrication	Oil lubrication
BNH 007	35	62	14	1	0.6	11600	9950	25000	35000
BNH 008	40	68	15	1	0.6	14800	12900	22000	32000
BNH 009	45	75	16	1	0.6	15500	14500	20000	28000
BNH 010	50	80	16	1	0.6	16100	15900	19000	26000
BNH 011	55	90	18	1	0.6	20000	20100	17000	24000
BNH 012	60	95	18	1.1	0.6	20800	21900	16000	22000
BNH 013	65	100	18	1.1	0.6	21500	23400	15000	21000
BNH 014	70	110	20	1.1	0.6	29400	31500	13000	19000
BNH 015	75	115	20	1.1	0.6	29800	32500	13000	18000
BNH 016	80	125	22	1.1	0.6	35000	39000	12000	17000
BNH 017	85	130	22	1.1	0.6	35500	40000	11000	16000
BNH 018	90	140	24	1.5	1	46500	53000	10000	15000
BNH 019	95	145	24	1.5	1	47000	55000	10000	14000
BNH 020	100	150	24	1.5	1	48000	56500	9600	14000
BNH 021	105	160	26	2	1	54500	65000	9100	13000
BNH 022	110	170	28	2	1	61000	74000	8600	12000
BNH 024	120	180	28	2	1	63000	79000	8000	11000
BNH 026	130	200	33	2	1	83500	105000	7300	10000
BNH 028	140	210	33	2	1	86000	112000	6900	9700
BNH 030	150	225	35	2.1	1	102000	132000	6400	9100
BNH 032	160	240	38	2.1	1	110000	145000	6000	8500
BNH 034	170	260	42	2.1	1	129000	173000	5600	7900

● Bearing No.

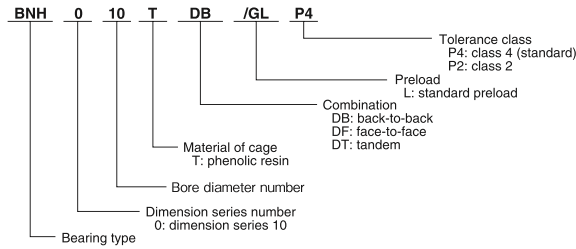

(2) Double-direction Thrust Angular Contact Ball Bearings - TAD20 Series

● Feature design

This is a double-row bearing with a one-piece outer ring. The ball assembly is arranged as a back-to-back, Angular Contact Ball Bearings with a high contact angle. This type is used as the Axial carrying Bearing in conjunction with a Double-row Cylindrical Roller Bearings.

● Bearing No.

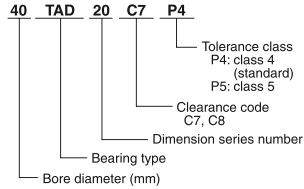

● Tolerance

The outer ring is made with a negative tolerance for a clearance fit in the housing. This enables the associated radial bearing to carry a radial load.

● Standard preload

Bore Diameter Number	Standard preload (N)	
	C7	C8
20TAD20	215	590
30TAD20		
35TAD20	245	
40TAD20		685
45TAD20	295	785
50TAD20	345	880
55TAD20		
60TAD20	390	980
65TAD20		
70TAD20	590	1250
75TAD20		1350
80TAD20	685	1750
85TAD20		2150
90TAD20	1050	2850
95TAD20		2950
100TAD20	1150	
105TAD20		3450
110TAD20	1450	4400
120TAD20		1650
130TAD20	1750	4700
140TAD20		1950
150TAD20	2750	6350
160TAD20		6850
170TAD20	2950	8800
180TAD20		
190TAD20	3900	
200TAD20	4100	11800

Inner Ring and Height Tolerances

Nominal bearing bore diameter d (mm)	Single plane mean bore diameter deviation Δd_{mb}												Variation of assembled height T		Width variation of inner ring V_{rs} (Max)		Side face runout with reference to bore S_f (Max)		Side face runout with reference to recovery of assembled bearing inner ring and of assembled bearing outer ring S_{ra}, S_{ra} (Max)	
	Class 5						Class 4						High	Low	Class 5	Class 4	Class 5	Class 4	Class 5	Class 4
	Over	Incl.	High	Low	High	Low	High	Low	Class 5	Class 4	Class 5	Class 4								
18	30	0	-6	0	-5	0	-300	5	2.5	8	4	5	3							
30	50	0	-8	0	-6	0	-400	5	3	8	4	5	3							
50	80	0	-9	0	-7	0	-500	6	4	8	5	6	5							
80	120	0	-10	0	-8	0	-600	7	4	9	5	6	5							
120	180	0	-13	0	-10	0	-700	8	5	10	6	8	6							
180	250	0	-15	0	-12	0	-800	10	6	11	7	8	6							

Variation and deviation of outer ring

Nominal bearing bore diameter D (mm)	Single plane mean outside diameter deviation ΔD_{mb}				Width variation of inner ring V_{cs} (Max)		Outside inclination of outer ring S_o (Max)	
	Class 5 - Class 4				Class 5	Class 4	Class 5	Class 4
	Over	Incl.	High	Low				
18	30	-20	-27	5	2.5	8	4	
30	50	-24	-33	6	3	8	4	
50	80	-28	-38	8	4	9	5	
80	120	-33	-44	8	5	10	5	
120	180	-33	-46	8	5	10	5	
180	250	-37	-52	10	7	11	7	
250	315	-41	-59	11	7	13	8	

(3) Combination Angular Contact Ball Bearings Type TAH10, TBH10

● Feature design

The ball diameter and quantity are the same as Double-direction Thrust Angular Contact Ball Bearings type TAD20. The contact angle is 30° for TAH10 type and 40° for TBH10 type. They are suitable for high-speed. Their Duplex Combination width 2B of type DB or DF is the same as width B1 of TAD20 type. TAD20 type are interchangeable to TAH10 type or TBH10 type by changing the method of setting to shaft.

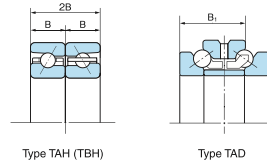

● Standard preload

Bore Diameter Number	Bearing	
	TAH	TBH
50	294	539
55		
60	392	686
65		
70		
75	588	1080
80		
85	686	1270
90		
95	1080	1860
100		
105	1180	2060
110	1370	2450
120	1470	2550
130	1860	3330
140	1960	3530
150	2450	4310
160	2650	4510
170	3040	5300

● Tolerance of outside diameter

The outside diameter of the outer ring is made with a special tolerance for a clearance fit in the housing. This enables the associated radial bearing to carry a radial load, like as TAD20 type.

Tolerance of outside diameter Unit: μm

Nominal bearing outside diameter D (mm)	Incl.	Outside diameter deviation ΔD_s	
		High	Low
30	50	-20	-41
50	80	-30	-49
80	120	-36	-58
120	180	-43	-68
180	250	-50	-79
250	315	-56	-88

JIS (ISO) class 4 for other tolerances

● Bearing No.

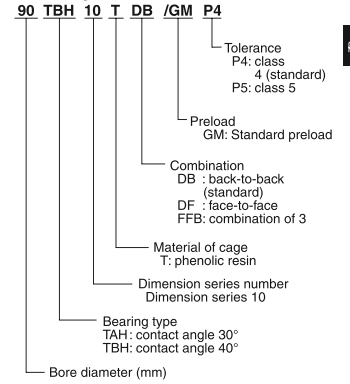

Double-direction Thrust Angular Contact Ball Bearings
TAD20 Series

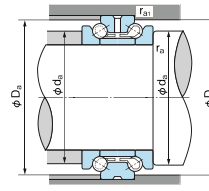
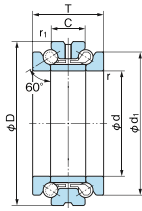

1N=0.102kgf

d	Boundary dimensions (mm)								Bearing No.		Basic dynamic load rating Ca (N)	Basic static load rating Coa (N)	Limiting speed (min ⁻¹)		Abutment and fillet dimensions (mm)				Mass (kg)	Bearing No. Standard type
	Standard type	d Large bore type(*)	D	d ₁	T	C	r (min)	r ₁ (min)	Standard type	Large bore type (*)			Grease lubrication	Oil lubrication	d _a (min)	D _a (max)	r _a (max)	r _{a1} (max)		
25	27	47	40	28	14	0.6	0.3	25TAD20	27TAD20	10700	19900	8000	10000	33	43.5	0.6	0.3	0.197	25TAD20	
30	32	55	47	32	16	1	0.6	30	32	14000	27100	7000	9000	39	51	1	0.6	0.301	30	
35	37	62	53	34	17	1	0.6	35	37	16200	33000	6200	8200	45	58	1	0.6	0.394	35	
40	42	68	58.5	36	18	1	0.6	40TAD20	42TAD20	18600	39500	5800	7800	50	64	1	0.6	0.482	40TAD20	
45	47	75	65	38	19	1	0.6	45	47	21200	47000	5500	7300	56	71	1	0.6	0.605	45	
50	52	80	70	38	19	1	0.6	50	52	22000	52000	5000	6700	61	76	1	0.6	0.656	50	
55	57	90	78	44	22	1.1	0.6	55TAD20	57TAD20	29900	71500	4500	6200	68	85	1	0.6	0.988	55TAD20	
60	62	95	83	44	22	1.1	0.6	60	62	30500	75000	4300	6000	73	90	1	0.6	1.06	60	
65	67	100	88	44	22	1.1	0.6	65	67	31500	81500	4100	5500	78	95	1	0.6	1.12	65	
70	73	110	97	48	24	1.1	0.6	70TAD20	73TAD20	37500	99000	3800	5200	85	105	1	0.6	1.53	70TAD20	
75	78	115	102	48	24	1.1	0.6	75	78	38500	107000	3600	4900	90	110	1	0.6	1.16	75	
80	83	125	110	54	27	1.1	0.6	80	83	51000	138000	3400	4500	97	119	1	0.6	2.20	80	
85	88	130	115	54	27	1.1	0.6	85TAD20	88TAD20	51500	144000	3200	4300	102	124	1	0.6	2.31	85TAD20	
90	93	140	123	60	30	1.5	1	90	93	59000	166000	3000	4000	109	132	1.5	1	3.05	90	
95	98	145	128	60	30	1.5	1	95	98	59500	173000	2900	3900	114	137	1.5	1	3.18	95	
100	103	150	133	60	30	1.5	1	100TAD20	103TAD20	60500	180000	2800	3700	119	142	1.5	1	3.32	100TAD20	
105	109	160	142	66	33	2	1	105	109	67000	199000	2600	3500	125	151	2	1	4.19	105	
110	114	170	150	72	36	2	1	110	114	81500	236000	2500	3300	132	161	2	1	5.35	110	
120	124	180	160	72	36	2	1	120TAD20	125TAD20	84000	256000	2300	3100	142	171	2	1	5.73	120TAD20	
130	135	200	177	84	42	2	1	130	135	109000	325000	2100	2800	156	190	2	1	8.58	130	
140	145	210	187	84	42	2	1	140	145	113000	355000	2000	2600	166	200	2	1	9.10	140	
150	155	225	200	90	45	2.1	1.1	150TAD20	155TAD20	123000	390000	1850	2500	178	213	2	1	11.2	150TAD20	
160	165	240	212	96	48	2.1	1.1	160	165	138000	435000	1750	2350	190	227	2	1	13.6	160	
170	176	260	230	108	54	2.1	1.1	170	176	175000	550000	1600	2150	204	246	2	1	18.5	170	
180	187	280	248	120	60	2.1	1.1	180TAD20	187TAD20	200000	640000	1500	2000	220	264	2	1	24.7	180TAD20	
190	197	290	258	120	60	2.1	1.1	190	197	203000	665000	1450	1950	230	274	2	1	25.5	190	
200	207	310	274	132	66	2.1	1.1	200	207	257000	835000	1350	1800	244	292	2	1	32.7	200	

Note: (*) Large bore type bearings are used at large bore side of cylindrical roller bearings with tapered bore NN3000K type.

■ Combination Angular Contact Ball Bearings
TAH10 Series

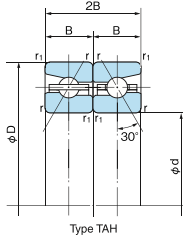

1N=0.102kgf

Bearing No.	Dimensions (mm)					Basic dynamic load rating Ca (N)	Basic static load rating C0a (N)	Limiting speed (min ⁻¹)	
	d	D	2B	r (min)	r ₁ (min)			Grease lubrication	Oil lubrication
50TAH10DB	50	80	28.5	1	0.6	19200	40500	9200	11000
55TAH10DB	55	90	33	1.1	0.6	23800	51000	8300	9700
60TAH10DB	60	95	33	1.1	0.6	24700	56000	7700	9000
65TAH10DB	65	100	33	1.1	0.6	25600	61000	7300	8500
70TAH10DB	70	110	36	1.1	0.6	35000	80000	6700	7800
75TAH10DB	75	115	36	1.1	0.6	35500	83500	6300	7400
80TAH10DB	80	125	40.5	1.1	0.6	41500	99500	5900	6800
85TAH10DB	85	130	40.5	1.1	0.6	42000	104000	5600	6500
90TAH10DB	90	140	45	1.5	1	55500	135000	5200	6100
95TAH10DB	95	145	45	1.5	1	56000	141000	5000	5800
100TAH10DB	100	150	45	1.5	1	57000	147000	4800	5600
105TAH10DB	105	160	49.5	2	1	64500	168000	4500	5300
110TAH10DB	110	170	54	2	1	73000	191000	4300	5000
120TAH10DB	120	180	54	2	1	75000	207000	4000	4700
130TAH10DB	130	200	63	2	1	99500	269000	3600	4200
140TAH10DB	140	210	63	2	1	103000	291000	3400	4000
150TAH10DB	150	225	67.5	2.1	1.1	121000	340000	3200	3700
160TAH10DB	160	240	72	2.1	1.1	131000	375000	3000	3500
170TAH10DB	170	260	81	2.1	1.1	154000	445000	2800	3300

■ Combination Angular Contact Ball Bearings
TBH10 Series

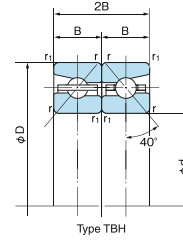

1N=0.102kgf

Bearing No.	Dimensions (mm)					Basic dynamic load rating Ca (N)	Basic static load rating C0a (N)	Limiting speed (min ⁻¹)	
	d	D	2B	r (min)	r ₁ (min)			Grease lubrication	Oil lubrication
50TBH10DB	50	80	28.5	1	0.6	22800	53000	7700	9200
55TBH10DB	55	90	33	1.1	0.6	28200	67000	6900	8300
60TBH10DB	60	95	33	1.1	0.6	29300	73000	6500	7700
65TBH10DB	65	100	33	1.1	0.6	30000	79500	6100	7300
70TBH10DB	70	110	36	1.1	0.6	41500	104000	5600	6700
75TBH10DB	75	115	36	1.1	0.6	42000	109000	5300	6300
80TBH10DB	80	125	40.5	1.1	0.6	49000	130000	4900	5900
85TBH10DB	85	130	40.5	1.1	0.6	50000	136000	4700	5600
90TBH10DB	90	140	45	1.5	1	65500	176000	4300	5200
95TBH10DB	95	145	45	1.5	1	66500	184000	4200	5000
100TBH10DB	100	150	45	1.5	1	67500	191000	4000	4800
105TBH10DB	105	160	49.5	2	1	76500	219000	3800	4500
110TBH10DB	110	170	54	2	1	86000	249000	3600	4300
120TBH10DB	120	180	54	2	1	88500	269000	3300	4000
130TBH10DB	130	200	63	2	1	118000	350000	3000	3600
140TBH10DB	140	210	63	2	1	121000	380000	2900	3400
150TBH10DB	150	225	67.5	2.1	1.1	143000	445000	2700	3200
160TBH10DB	160	240	72	2.1	1.1	155000	490000	2500	3000
170TBH10DB	170	260	81	2.1	1.1	182000	580000	2300	2800

Ball Screw Support Bearings

This type is used for supporting the ball screws that are used as actuators of high precision and high speed machines, precision measurement

equipment, robots, etc. This is a precision and high ability bearing.

● Feature design

(1) High stiffness

These bearings are designed with polyamide cages and a greater number of balls than conventional angular contact ball bearings. For these reasons, bearing stiffness is greater than conventional bearings.

(2) Easy fitting and adjustment

These bearings are supplied with a pre-set preload so difficult adjustment and torque measurement is eliminated.

(3) Simplified bearing mounting structure

These bearings are supplied with a 60° contact angle so radial and thrust load combinations can be sustained. This results in a simplified and compact shaft and housing design.

(4) Available with seal

Seals come in both contact seal and non-contact seal types. It is possible to choose the type that best suits the application.

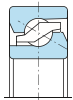

Open type

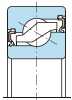

Contact seal

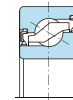

Non-contact seal

Duplex sets



DF

Triplex sets

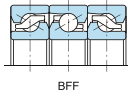

BFF

Quad sets

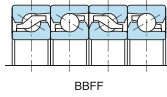

BBFF



DB

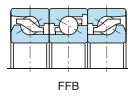

FFB

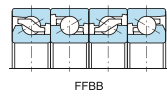

FFBB



DT

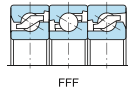

FFF

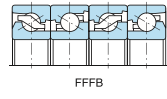

FFFB

(Sealed bearings are sealed on the outside edges only when used in combination.)

● Bearing No.

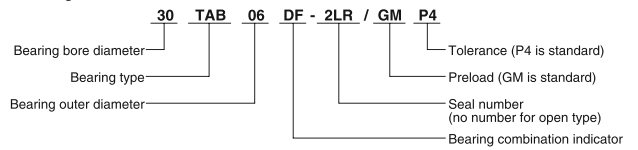

Flush ground (universal matching)

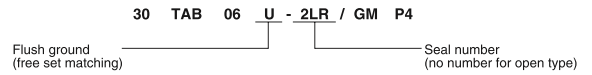

● Tolerances

Tolerances for inner ring (outer ring width/axial runout)

Unit: μm

Nominal bearing bore diameter (mm)	Single plane mean bore diameter variation ΔD_{mp} , ΔD_s	Bore diameter variation in a single radial plane V_{ϕ} (Max)				Mean bore diameter variation V_{mp} (Max)	Deviation of a single ⁽¹⁾ inner ring width (or a single outer ring width) ΔB_s (ΔC_s)				Width deviation V_{ϕ} of inner ring (Max)		Radial runout of assembled bearing inner ring K_{ϕ} (Max)		Side face runout S_{ϕ} with reference to bore (Max)		Side face runout with reference to raceway of assembled bearing inner ring S_{ϕ} and of assembled bearing outer ring S_{ϕ} (Max)				
		P5		P4			P5		P4		P5	P4	P5	P4	P5	P4	P5	P4			
		High	Low	High	Low		High	Low	High	Low	High	Low	High	Low	High	Low	High	Low			
Over	Incl.																				
10	18	0	-5	0	-4	4	3	4	3	0	-80	0	-80	5	2.5	4	2.5	7	3	4	2
18	30	0	-6	0	-5	5	4	5	4	0	-120	0	-120	5	2.5	4	3	8	4	5	2.5
30	50	0	-8	0	-6	6	5	6	5	0	-120	0	-120	5	3	5	4	8	4	6	2.5
50	60	0	-9	0	-7	7	6	7	6	0	-150	0	-150	6	4	5	4	8	5	7	2.5

Note: (1) These deviations are for single bearing. For combination bearings, multiply these values by row number.

Tolerances for outer ring

Unit: μm

Nominal bearing outside diameter (mm)	Single plane mean outside diameter variation of outer ring ΔD_{mp} , ΔD_s	Outside diameter variation in a single radial plane V_{ϕ} (Max)				Mean outside diameter variation V_{mp} (Max)	Width deviation V_{ϕ} of outer ring (Max)		Radial runout of assembled bearing outer ring K_{ϕ} (Max)		Outside inclination of outer ring S_{ϕ} (Max)				
		P5		P4			P5	P4	P5	P4	P5	P4			
		High	Low	High	Low		High	Low	High	Low	High	Low			
Over	Incl.														
30	50	0	-7	0	-6	5	5	4	3	5	2.5	7	5	8	4
50	80	0	-9	0	-7	7	5	5	3.5	6	3	8	5	8	4
80	120	0	-10	0	-8	8	6	5	4	8	4	10	6	9	5

● Preload and Axial Spring Constant

Bearing No.	Standard Preload M (N) Combination Mounted Bearing				Axial Spring Constant (N/μm) Combination Mounted Bearing			
	DF DB	BFF FFB	BBFF FFBB	BFFF FFFB	DF DB	BFF FFB	BBFF FFBB	BFFF FFFB
15TAB04	2160	2940	4310	3430	735	1080	1470	1320
17TAB04	2160	2940	4310	3430	735	1080	1470	1320
20TAB04	2160	2940	4310	3430	735	1080	1470	1320
25TAB06	3330	4510	6670	5200	981	1470	1960	1910
30TAB06	3330	4510	6670	5200	981	1470	1960	1910
35TAB07	3920	5300	7840	6180	1230	1770	2350	2300
40TAB07	3920	5300	7840	6180	1230	1770	2350	2300
40TAB09	5200	7060	10400	8140	1320	1910	2550	2500
45TAB07	4120	5590	8240	6470	1270	1910	2550	2500
45TAB10	5980	8140	12000	9410	1470	2160	2890	2790
50TAB10	6280	8530	12600	9810	1520	2260	3040	2940
55TAB10	6280	8530	12600	9810	1520	2260	3040	2940
55TAB12	7060	9610	14100	11100	1770	2550	3480	3380
60TAB12	7060	9610	14100	11100	1770	2550	3480	3380

● Shaft and housing tolerance:

(1) For the fit, refer to the following table.

Shaft fit	h5
Housing fit	H6

(2) For the squareness of a shoulder, refer to the following table.

Dimensions of shaft diameter and housing bore diameter (mm)		Squareness (μm)
Over	Incl.	
—	80	4
80	120	5

● Axial Load and Axial Displacement

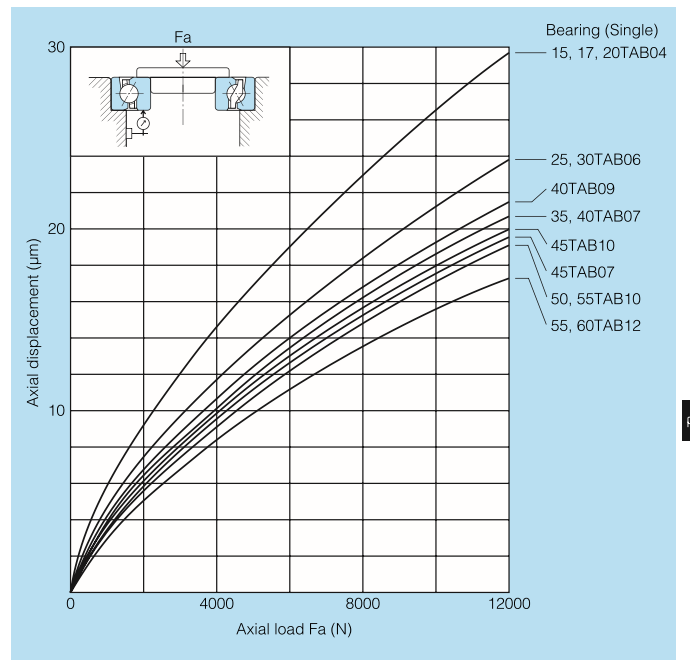

Ball Screw Support Bearings
TAB Series

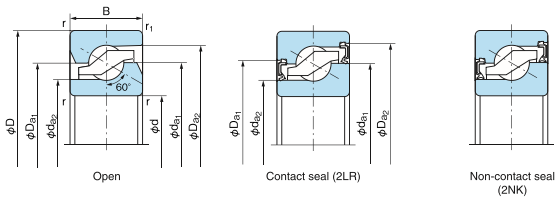

Dynamic equivalent axial load

$P_a = XFr + YFa$

Brgs loaded axial load	No. of Bearing in set	2			3			4				
		1	2	3	1	2	3	1	2	3	4	
Fa/Fr ≤ e	X	1.9	—	1.43	2.33	—	1.17	2.33	2.53	—	—	—
	Y	0.54	—	0.77	0.35	—	0.89	0.35	0.26	—	—	—
Fa/Fr > e	X	0.92	0.92	0.92	0.92	0.92	0.92	0.92	0.92	0.92	0.92	0.92
	Y	1	1	1	1	1	1	1	1	1	1	1

e=2.17

1N=0.102kgf

d	Boundary dimensions (mm)					Bearing No.	Basic dynamic load rating (F) Ca (N)	Axial limiting load (F) Coa (N)	Limiting speed (min ⁻¹)	Starting torque (N·cm)	Reference Dimensions (mm)				Mass (kg) (Reference)	Bearing No.
	D	B	r (min)	r ₁ (min)	Grease lubrication						Dil lubrication	d _{a1}	d _{a2}	D _{a1}		
15	47	15	1 ⁽¹⁾	0.6	15TAB04DF(DB)	25900	32000	6300	8000	15	33.7	26.8	33.5	41	0.14	15TAB04DF(DB)
	47	15	1 ⁽¹⁾	0.6	15TAB04DF(DB)-2NK	25900	32000	6300	—	—	33.7	26.8	35	41.9	0.14	15TAB04DF(DB)-2NK
	47	15	1 ⁽¹⁾	0.6	15TAB04DF(DB)-2LR	25900	32000	6300	—	—	33.7	26.8	35	41.9	0.14	15TAB04DF(DB)-2LR
17	47	15	1	0.6	17TAB04DF(DB)	25900	32000	6300	8000	15	33.7	26.8	33.5	41	0.13	17TAB04DF(DB)
	47	15	1	0.6	17TAB04DF(DB)-2NK	25900	32000	6300	—	—	33.7	26.8	35	41.9	0.13	17TAB04DF(DB)-2NK
	47	15	1	0.6	17TAB04DF(DB)-2LR	25900	32000	6300	—	—	33.7	26.8	35	41.9	0.13	17TAB04DF(DB)-2LR
20	47	15	1	0.6	20TAB04DF(DB)	25900	32000	6300	8000	15	33.7	26.8	33.5	41	0.12	20TAB04DF(DB)
	47	15	1	0.6	20TAB04DF(DB)-2NK	25900	32000	6300	—	—	33.7	26.8	35	41.9	0.12	20TAB04DF(DB)-2NK
	47	15	1	0.6	20TAB04DF(DB)-2LR	25900	32000	6300	—	—	33.7	26.8	35	41.9	0.12	20TAB04DF(DB)-2LR
25	62	15	1	0.6	25TAB06DF(DB)	29900	46400	4650	6000	20	46.2	39.7	46	53.4	0.24	25TAB06DF(DB)
	62	15	1	0.6	25TAB06DF(DB)-2NK	29900	46400	4650	—	—	46.2	39.7	47.5	54.9	0.24	25TAB06DF(DB)-2NK
	62	15	1	0.6	25TAB06DF(DB)-2LR	29900	46400	4650	—	—	46.2	39.7	47.5	54.9	0.24	25TAB06DF(DB)-2LR
30	62	15	1	0.6	30TAB06DF(DB)	29900	46400	4650	6000	20	46.2	39.7	46	53.4	0.21	30TAB06DF(DB)
	62	15	1	0.6	30TAB06DF(DB)-2NK	29900	46400	4650	—	—	46.2	39.7	47.5	54.9	0.21	30TAB06DF(DB)-2NK
	62	15	1	0.6	30TAB06DF(DB)-2LR	29900	46400	4650	—	—	46.2	39.7	47.5	54.9	0.21	30TAB06DF(DB)-2LR
35	72	15	1	0.6	35TAB07DF(DB)	32500	54300	3750	5000	25	56.2	49.7	56	63.4	0.29	35TAB07DF(DB)
	72	15	1	0.6	35TAB07DF(DB)-2NK	32500	54300	3750	—	—	56.2	49.7	57.5	64.9	0.29	35TAB07DF(DB)-2NK
	72	15	1	0.6	35TAB07DF(DB)-2LR	32500	54300	3750	—	—	56.2	49.7	57.5	64.9	0.29	35TAB07DF(DB)-2LR
40	72	15	1	0.6	40TAB07DF(DB)	32500	54300	3750	5000	25	56.2	49.7	56	63.4	0.26	40TAB07DF(DB)
	72	15	1	0.6	40TAB07DF(DB)-2NK	32500	54300	3750	—	—	56.2	49.7	57.5	64.9	0.26	40TAB07DF(DB)-2NK
	72	15	1	0.6	40TAB07DF(DB)-2LR	32500	54300	3750	—	—	56.2	49.7	57.5	64.9	0.26	40TAB07DF(DB)-2LR
	90	20	1	0.6	40TAB09DF(DB)	65000	101000	3150	4000	30	67.2	57.2	67	78.4	0.62	40TAB09DF(DB)
	90	20	1	0.6	40TAB09DF(DB)-2NK	65000	101000	3150	—	—	67.2	57.2	68.5	79.9	0.62	40TAB09DF(DB)-2NK
	90	20	1	0.6	40TAB09DF(DB)-2LR	65000	101000	3150	—	—	67.2	57.2	68.5	79.9	0.62	40TAB09DF(DB)-2LR
45	75	15	1	0.6	45TAB07DF(DB)	33500	59500	3400	4500	50	61.7	55.2	61.5	68.9	0.25	45TAB07DF(DB)
	100	20	1	0.6	45TAB10DF(DB)	69000	113000	2850	3500	60	74.2	64.2	74	85.4	0.79	45TAB10DF(DB)
50	100	20	1	0.6	50TAB10DF(DB)	69500	119000	2700	3500	65	78.2	68.2	78	89.4	0.72	50TAB10DF(DB)
55	100	20	1	0.6	55TAB10DF(DB)	69500	119000	2700	3500	65	78.2	68.2	78	89.4	0.95	55TAB10DF(DB)
55	120	20	1	0.6	55TAB12DF(DB)	73000	137000	2300	3000	70	92.2	82.2	92	103.4	1.15	55TAB12DF(DB)
60	120	20	1	0.6	60TAB12DF(DB)	73000	137000	2300	3000	70	92.2	82.2	92	103.4	1.08	60TAB12DF(DB)

Notes: ⁽¹⁾ r (min) = 0.6 for inner ring
⁽²⁾ When bearing sets carry axial load with two or three rows, the numbers should be multiplied by 1.64 or 2.16.
⁽³⁾ When bearing sets carry axial load with two or three rows, the numbers should be multiplied by 2 or 3.

Bearings for Turntable Applications

Cross Tapered Roller Bearings

This bearing type is designed with two inner rings and one outer ring. The rolling elements (Tapered rollers) are arranged with their surfaces contact the ring raceways in an alternating pattern.

• Feature design

- (1) This type can sustain radial, overturning moment and bi-directional axial loads.
- (2) Change in size due to thermal growth does not affect this type of bearing. Preload is stable over the entire temperature operating range.
- (3) Light weight, compact, easy to assemble.

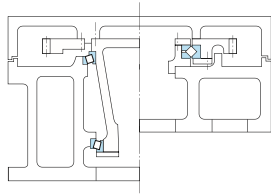

Example of mounting of Tapered Roller Bearings and Cross Tapered Roller Bearing

• Applications

- (1) Worktable of machining centers or vertical grinding machines
- (2) Work-spindle of lathes or grinding machines
- (3) The indexing mechanisms of large milling machines or drilling machines
- (4) Turntable mechanism of parabolic antenna

• Tolerances

Bearing No.	Single plane mean bore diameter deviation Δd_{mp}		Single plane mean outside diameter deviation ΔD_{mp}		Variation of assembled height T		Outer ring runout Max (μm)	
	High	Low	High	Low	High	Low	Radial runout	Sideface runout
200XRN28	0	-15	0	-18	+350	-250	7	7
250XRN35	0	-10	0	-13	+350	-250	9	9
300XRN40	0	-13	0	-15	+350	-250	7	7
350XRN47	0	-13	0	-15	+350	-250	9	9
400XRN55	0	-13	0	-18	+350	-250	9	9
0457XRN060	+25	0	+25	0	+380	-380	9	9
580XRN76	+25	0	+38	0	+406	-406	10	10
600XRN83	+38	0	+38	0	+406	-406	12	12
0685XRN091	+38	0	+38	0	+508	-508	12	12
0901XRN112	+51	0	+51	0	+508	-508	14	14
1028XRN132	+76	0	+76	0	+760	-760	16	16

• Axial Load and Axial Displacement

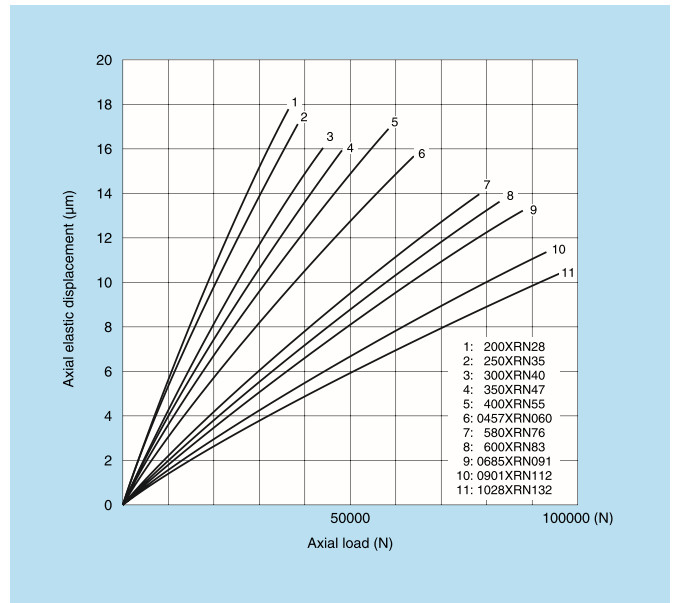

Cross Tapered Roller Bearings

Bore Diameter: 200~1028.7mm

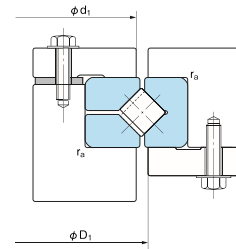
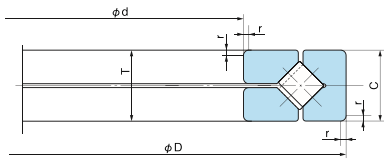

1N=0.102kgf

Bearing No.	Boundary dimensions (mm)				Basic dynamic load rating Ca (N)	Basic static load rating Coa (N)	Limiting speed (min ⁻¹)		Abutment and fillet dimensions (mm)			Bearing No.
	d	D	T (C)	r			Grease lubrication	Oil lubrication	d ₁ (min)	D ₁ (max)	ra (max)	
200XRN28 ()	200	280	30	1.5	144000	520000	480	950	235	249	1	*200XRN28 (*)
250XRN35 ()	250	350	40	3	170000	680000	400	800	302	312	1.5	*250XRN35 (*)
300XRN40 ()	300	400	38	3	268000	985000	330	650	345	369	2.5	*300XRN40 (*)
350XRN47 ()	350	470	50	3	284000	1230000	280	560	410	424	1.5	*350XRN47 (*)
400XRN55 ()	400	550	60	3.5	365000	1900000	250	500	475	492	1.5	*400XRN55 (*)
0457XRN060	457.2	609.6	63.5	3.3	370000	1670000	220	440	535	554	2	0457XRN060
580XRN76	580	760	80	6.4	830000	3800000	170	340	667	691	4	580XRN76
600XRN83	600	830	80	3.3	1030000	4600000	160	320	708	738	2	600XRN83
0685XRN091	685.8	914.4	79.375	3.3	1090000	5000000	140	280	807	834	2	0685XRN091
0901XRN112	901.7	1117.6	82.55	3.3	1090000	5650000	110	220	1013	1037	2	0901XRN112
1028XRN132	1028.7	1327.15	114.3	3.3	1830000	9300000	90	180	1184	1221	2	1028XRN132

Note: (*) Inner and outer diameters for bearings marked with * have minus (-) deviation.
 Remark: This table is for bearings used in longitudinal rotating applications (such as tables).



Bearings for Rolling Stock

Various types of bearings are used as "rolling stock" bearings in railway axle-boxes. Cylindrical Roller Bearings and Tapered Roller Bearings are currently the bearing types most often favored for use since they can sustain high loads and provide excellent reliability.

● Journal Bearings

Double-row Cylindrical Roller Bearings or Double-row Tapered Roller Bearings for Journal applications are used for each of their capabilities. Cylindrical Roller Bearings are mostly used for easy maintenance and adaptability of high-speed. But in recent years, Tapered Roller Bearings are often used for adaptability of high-speed and long life without overhaul.

JIS (ISO) standard bearings are generally not used in journal bearing applications due to limited space and large load.

Journal bearings are specially designed wider bearings.

Cylindrical Roller bearings without a rib on the inner ring are used with the JB series Ball Bearings that handle axial loads.

Sealed Tapered Roller Bearings and sealed Cylindrical Roller Bearings with side ribs on the inner ring to carry thrust loads can be used for extended periods without overhaul. For this reason sealed bearings are used more often recently.

Bearings with a prefix JC, JT and JB are made to the specifications of Japan Railway Companies. A FCD type is made to NACHI design standards.

● Bearings for Gear box

These are bearings for a gearwheel and a pinion. They are mostly Tapered Roller Bearings, because they can sustain radial and large axial loads. They are lubricated with high viscosity gear oil, so the bearings for a pinion application are usually designed specially to prevent seizure at lower temperature. Also these bearings have been specially designed to withstand the severe vibration conditions which are normally found in this type application.

QT type bearings are made to the specifications of Japan Railway Companies, a ED type is made to NACHI design standards.

● Bearings for Traction motor

For traction motor, Deep-groove Ball Bearings and Cylindrical Roller Bearings without inner ring ribs are usually used together. These bearings have been specially designed to withstand high speed in grease lubrication and the severe vibrational load conditions.

NACHI bearing numbers for the traction motor applications have suffix JT for Deep-groove Ball Bearings and T, TS, or TSL for Cylindrical Roller Bearings.

● Special designs

Contact NACHI for the availability of other sizes.

Journal Bearings for Railway Rolling Stock

Cylindrical Roller Bearings

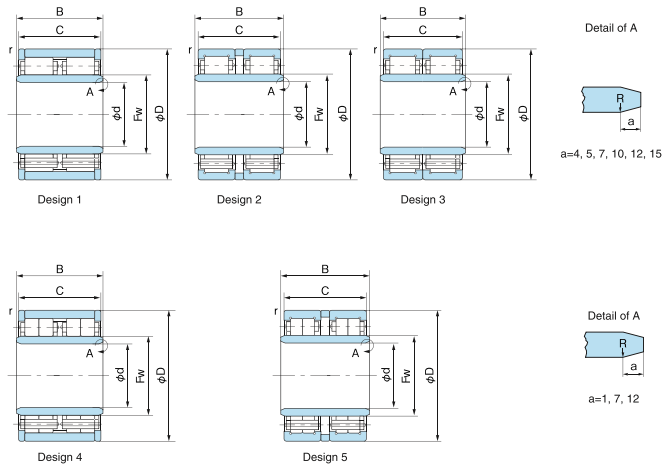

1N=0.102kgf

Bearing No.	Design No.	Boundary dimensions (mm)						Basic dynamic load rating Cr (N)	Basic static load rating Cor (N)	Mass (kg) Reference
		d	D	C	B	Fw	r			
FCD75	1	75	155	90	100	95	1	287000	410000	7
FCD85S1	3	85	150	96	106	101.5	3	335000	590000	6
FCF85S	5	85	150	120	120	101.5	3	320000	560000	7
FCD85S	2	85	150	120	130	101.5	3	335000	590000	7
FCD95	1	95	170	105	120	113.5	1	380000	645000	11
FCF100	4	100	180	140	160	120	2	565000	1040000	14
JC3	4	110	200	160	180	134	2	575000	1190000	19
FCF110	4	110	210	160	180	136	2	720000	1280000	22
FCF110S1	4	110	180	140	160	127	2	795000	1370000	28
FCD110S5	1	110	220	160	180	138	2	795000	1370000	28
JC1	1	110	225	140	150	138	2	750000	1430000	28
JC2	1	110	235	160	180	141	2	835000	1550000	36
FCF120S3	4	120	205	150	165	141	2	675000	1290000	18
FCF120S1	4	120	205	160	170	141	2	715000	1390000	19
FCF120S4	4	120	220	160	180	146	3	805000	1510000	23
FCD120S7	1	120	220	160	180	146	3	835000	1580000	23
JC11	1	120	240	160	180	150	2	810000	1580000	35
FCF120S2	4	120	240	160	180	150	2	960000	1700000	35
FCD120S1	2	120	260	190	195	154	4	1070000	1840000	50
FCF130S	4	130	220	160	170	152	2	785000	1550000	22
FCD130S	1	130	230	120	120	156	2	615000	1110000	19
FCF130S1	4	130	240	160	170	158	2	880000	1610000	35
JC5	1	130	260	160	180	163	2	875000	1710000	42
JC29	2	130	270	210	215	164	5	1170000	2000000	56
JC9	2	130	280	210	215	167	5	1070000	2090000	61
FCF130	5	130	280	210	215	167	5	1340000	2360000	61
FCD140B	2	140	300	225	230	180	5	1440000	2500000	76
FCD160S	1	160	270	130	140	187	2	850000	1600000	27
FCD160	1	160	280	150	180	190	2	970000	1820000	34

Radial Ball Bearings

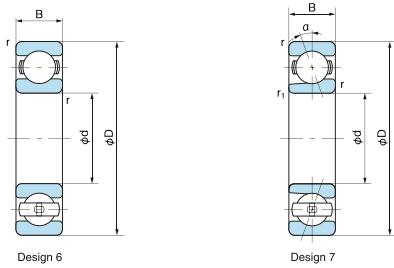

Bearing No.	Design No.	Boundary dimensions (mm)						Contact angle α°	Basic dynamic load rating Cr (N)	Basic static load rating Cor (N)	Mass (kg) Reference
		d	D	B	r	r1					
JB6A	6	70	150	35	3.5	—	—	80000	153000	4	
JB1D	7	85	180	41	4	2	20	98500	204000	5	
JB1E	7	85	180	41	4	2	20	114000	255000	5	
JB2	7	100	215	47	4	2	20	128000	292000	7	
JB3	7	110	215	47	4	2	30	164000	355000	6	
JB9	6	125	250	55	2	—	—	143000	350000	13	
JB4	6	125	250	55	4	—	—	172000	395000	12	

Journal Bearings for Railway Rolling Stock

Cylindrical Roller Bearings

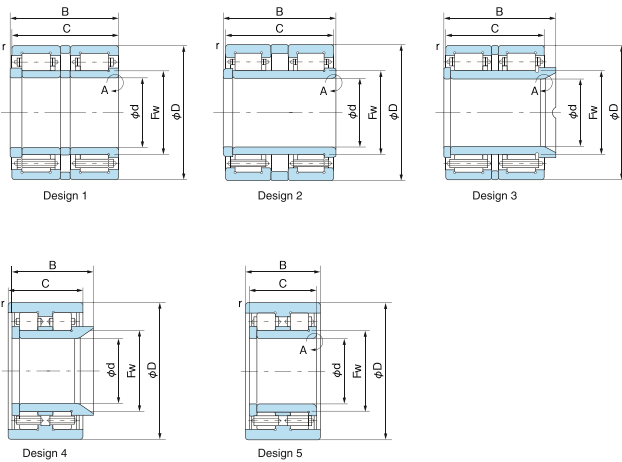

1N=0.102kgf

Bearing No.	Design No.	Boundary dimensions (mm)						Basic dynamic load rating Cr (N)	Basic static load rating Cor (N)	Mass (kg) Reference
		d	D	C	B	Fw	r			
FCD85S2	2	85	150	85	86.5	101.5	2	425000	765000	14
FCD100S	1	100	200	170	170	125	4	650000	1100000	25
FCD110S3	1	110	220	180	183	138	3.5	795000	1370000	28
FCD110S7	2	110	220	175	180	138	3.5	715000	1190000	29
JC6	2	110	220	180	180	138	3.5	625000	1190000	30
FCD110S9	1	110	220	180	183	138	3.5	795000	1370000	30
FCD110S11	2	110	220	180	185	138	3.5	795000	1370000	31
JC36	6	120	220	145	171	146	1	700000	1120000	22
FCD120S20	6	120	220	160	229.5	146	1	755000	1230000	24
FCD120S21	5	120	220	160	185.5	146	1	755000	1230000	24
FCD120S22	7	120	220	160	242	144	1	815000	1320000	24
FCD120S9	1	120	220	180	183	142	3.5	835000	1580000	26
JC30 · 32	6	120	230	150	171	147	1	755000	1300000	30
JC34	2	120	230	165	170	145	4	935000	1440000	31
JC26	6	120	240	160	193	150	1	850000	1420000	35
JC12	2	120	240	176	180	150	4	805000	1580000	38
JC17	6	120	240	170	218	150	1	815000	1580000	40
FCD120S4	1	120	240	180	183	150	4	855000	1470000	35
FCD120S5	2	120	240	180	185	150	4	855000	1470000	35
FCD120S3	2	120	260	190	195	154	4	1100000	1840000	50
JC38	2	125	235	165	170	150	3	940000	1460000	32
FCD130S8	6	130	240	160	229.5	158	1	855000	1350000	34
JC21	3	130	260	180	205.5	163	4	825000	1610000	46
FCD130S6	2	130	260	180	185	163	4	1030000	1610000	45
JC37	2	130	265	166	166	161.5	3	1140000	1710000	43
FCD130S3	4	130	270	153	165	160.5	3	715000	1110000	37
JC16	2	130	280	210	210	167	5	1070000	2090000	61

Sealed Cylindrical Roller Bearings

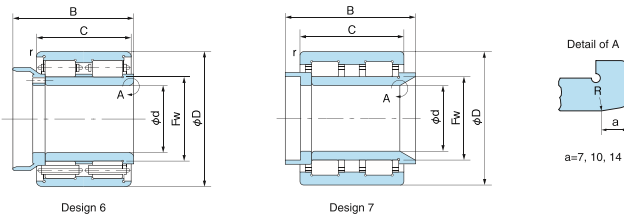

**Journal Bearings
for Railway Rolling Stock
Sealed Tapered Roller Bearings**

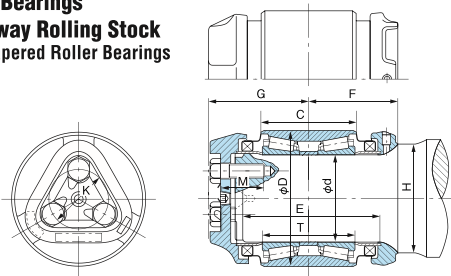

Bearing No.	Axle class	Size of journal	Applicable bearing No.	Boundary dimensions					mm (inch)							Basic dynamic load rating Cr (N)	Basic static load rating Cor (N)	Mass (kg) Reference
				d	D	C	T	E	F	G	H	K	Bolt size	M				
JT 9	—	110	JT 9	110	175	130	125	206	—	130	140.5	155	75	M22	50	375000	935000	22
JT14	—	110	JT14	110	190	150	145	—	—	150	134.4	150	75	M22	60	600000	1110000	25
JT10	—	120	JT10	120	195	142	136	217	—	142	149	155	75	M22	50	495000	1250000	27
JT12	—	120	JT12	120	220	155	155	—	—	155	159.4	150	75	M22	60	840000	1540000	39
JT11	—	130	JT11	130	208	152	146	227	—	152	150.7	165	89	M22	50	510000	1250000	30
AP50B	B	4-1/4 × 8	HM120848N/ HM120817XDND	101.600 (4)	165.100 (6-1/2)	114.300 (4-1/2)	107.950 (4-1/4)	200.025 (7-5/8)	—	117.5 (4-5/8)	130.2 (5-1/8)	127 (5)	61.9 (2-7/16)	3/4—10UNC-2A	44.45 (1-3/4)	390000	800000	20
AP50C	C	5 × 9	HM124646N/ HM124618XDND	119.062 (4-11/160)	195.262 (7-11/16)	142.875 (5-5/8)	136.525 (5-3/8)	217.488 (8-9/16)	—	134.9 (5-5/16)	147.6 (5-13/16)	149.2 (5-7/8)	76.2 (3)	7/8—9UNC-2A	50.80 (2)	590000	1250000	33
AP50D	D	5-1/2 × 10	HM127446N/ HM127415XDND	131.762 (5-3/16)	207.962 (8-3/16)	152.400 (6)	146.050 (5-3/4)	227.013 (8-15/16)	—	139.7 (5-1/2)	149.2 (5-7/8)	161.9 (6-3/8)	88.9 (3-1/2)	7/8—9UNC-2A	50.80 (2)	590000	1250000	37
AP50E	E	6 × 11	HM129848N/ HM129814XDND	144.462 (5-11/16)	220.662 (8-11/16)	163.512 (6-7/16)	155.575 (6-1/8)	241.300 (9-1/2)	—	150.8 (5-15/16)	165.1 (6-1/2)	177.8 (7)	98.4 (3-7/8)	1—8UNC-2A	57.15 (2-1/4)	650000	1480000	47
AP50F	F	6-1/2 × 12	HM133444N/ HM133416XDND	157.162 (6-3/16)	252.412 (9-15/16)	184.150 (7-1/4)	177.800 (7)	266.700 (10-1/2)	—	163.5 (6-7/16)	176.2 (6-15/16)	190.5 (7-1/2)	108.0 (4-1/4)	1-1/8—7UNC-2A	63.50 (2-1/2)	900000	1930000	66
AP50G	G	7 × 12	HM136948N/ HM136916XDND	177.800 (7)	276.225 (10-7/8)	185.739 (7-5/16)	180.975 (7-1/8)	254.000 (10)	—	150.8 (5-15/16)	177.8 (7)	203.2 (8)	117.5 (4-5/8)	1-1/4—7UNC-2A	69.85 (2-3/4)	975000	2170000	86

1N=0.102kgf

■ Bearings for Pinion

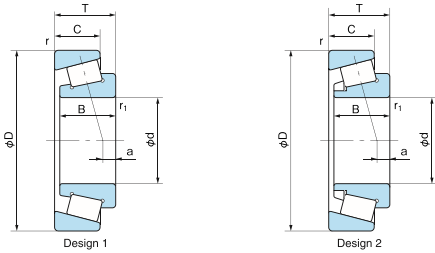

1N=0.102kgf

Bearing No.	Design No.	Boundary dimensions (mm)							Load center (mm)		Basic dynamic load rating Cr (N)	Basic static load rating Cor (N)	Mass (kg) Reference
		d	D	T	C	B	r	r ₁	a (°)	e			
QT9	1	70	150	38	25	35	3.5	3.5	-8.2	0.81	165000	200000	3
QT9B-2	2	70	150	38	25	35	3.5	3.5	-8.2	0.81	165000	200000	3
QT31	2	70	150	40	27	37	2.5	3	-6.5	0.81	175000	205000	3
30315ED	1	75	160	40	31	37	3.5	3.5	7.6	0.35	212000	238000	3
QT7	1	75	160	40	27	37	3.5	3.5	-10.2	0.81	192000	218000	3
TSM15ED	1	75	175	52	40	50	3.5	3.5	8.1	0.46	282000	320000	6
QT4	1	80	170	42.5	28	39	3.5	3.5	-10.0	0.81	221000	256000	4
QT18	1	85	180	45.5	29	42	4.0	4	-9.5	0.81	244000	284000	5

Note: (°) Minus value of load center indicates center is outside cone backface.

■ Bearings for Gearwheel

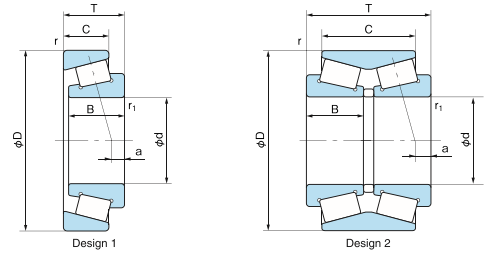

1N=0.102kgf

Bearing No.	Design No.	Boundary dimensions (mm)							Load center (mm)		Basic dynamic load rating Cr (N)	Basic static load rating Cor (N)	Mass (kg) Reference
		d	D	T	C	B	r	r ₁	a (°)	e			
32936ED	1	180	250	45	34	42	3	3	-3.7	0.39	325000	620000	6
QT1	2	190	280	110	85	46	1	4	-23.0	0.67	575000	1170000	23
32038ED	1	190	290	64	52	60	3.5	3.5	2.4	0.37	550000	955000	14
QT6	2	190	300	110	85	46	1	4	-26.5	0.67	670000	1260000	27
QT29	1	193.675	282.575	50.8	36.513	47.625	2.5	3	-4.3	0.42	345000	605000	11
QT26	1	195	280	58	41	60	3.5	3.5	4.4	0.37	410000	745000	11
QT25	1	200	280	51	41	48	2.5	3	-3.6	0.37	345000	680000	10
32940ED	1	200	280	51	41	48	3.5	3.5	-3.6	0.37	345000	680000	10
QT13	2	200	290	110	85	46	1	4	-26.5	0.67	605000	1280000	21
QT28	2	202.5	290	110	85	46	0.6	4	-27.3	0.67	605000	1270000	21
QT33	1	205	283	51	41	48	2.5	3	-3.6	0.37	355000	695000	10
QT5	1	210	320	70	56	66	3.5	3.5	2.5	0.40	630000	1110000	19
QT24	1	210	320	70	56	75	3.5	3.5	2.5	0.40	630000	1110000	20
QT19-1	1	214	330	70	56	70	3.5	3.5	1.5	0.40	670000	1190000	21
QT32	1	218	315	65	49	70	2.5	3	4.1	0.37	605000	1180000	16

Note: (°) Minus value of load center indicates center is outside cone backface.

Ball Bearings for Traction Motor

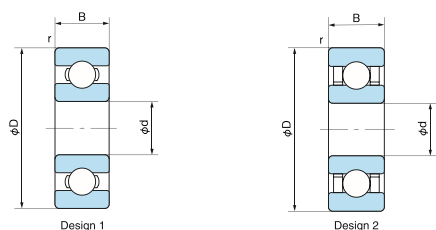

1N=0.102kgf

Bearing No.	Design No.	Boundary dimensions (mm)					Basic dynamic load rating Cr (N)	Basic static load rating Cor (N)	Mass (kg) Reference
		d	D	C	B	r			
6311JT	1	55	120	29	29	3	71500	44500	1.4
6312JT	1	60	130	31	31	3.5	81500	52000	1.7
6314JT	1	70	150	35	35	3.5	104000	68000	2.5
6219JT	1	95	170	32	32	3.5	109000	815000	2.6
6219T	2	95	170	32	32	3.5	109000	815000	3.0

Cylindrical Roller Bearings for Traction Motor

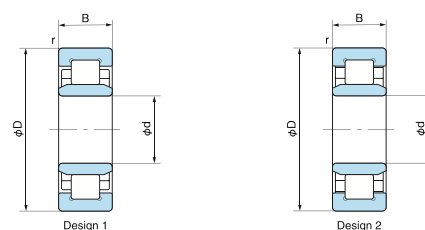

1N=0.102kgf

Bearing No.	Design No.	Boundary dimensions (mm)				Basic dynamic load rating Cr (N)	Basic static load rating Cor (N)	Mass (kg) Reference
		d	D	B	r			
NU214T	1	70	125	24	1.5	83000	95000	1.5
NU314T	1	70	150	35	2.1	158000	220000	3.1
NU315T	1	75	160	37	2.1	190000	205000	4.0
NU316T	1	80	170	39	2.1	190000	207000	4.6
NU316TSL	2	80	170	39	2.1			
NU219T	1	95	170	32	2.1	165000	195000	3.5
NU219TS	2	95	170	32	2.1			
NU220T	1	100	180	34	2.1	183000	217000	4.3



Sheave Bearings

This bearing type is designed as a double-row, full complement Cylindrical Roller bearing with ribs on both inner and outer rings. These bearings will sustain heavy radial load, and will handle moment load and will also take some axial load.

Sheave bearings are suitable for a wide variety of uses in addition to sheaves. They are used for hoisting drum and wheel applications, and other applications which operate under heavy load at low speed.

Bearing series	Description	Bearing series	Description
E50	This bearing series is designed for sheave application. It is a sealed (shield or seal) bearing and has a surface coating. The E50...NR and E50...NRNT have two snap rings in the outer ring. Series E50...NR is made with two shields, while the series E50...NRNT is made with two rubber seals.	RB48, RC48 RB49, RC49	These bearings are designed for general use. When mounting two or more bearings on an axle, the RB type should be used as a fixed side bearing and the RC type used as a free side bearing.

Deviation of bore diameter and bearing width Unit: μm

Nominal bearing bore diameter d (mm)		Deviation of d		Deviation of B	
Over	Incl.	High	Low	High	Low
30	50	0	-12	0	-120
50	80	0	-15	0	-150
80	120	0	-20	0	-200
120	150	0	-25	0	-250
150	180	0	-25	0	-250
180	250	0	-30	0	-300
250	315	0	-35	0	-350
315	400	0	-40	0	-400
400	500	0	-45	0	-450

Deviation of outside diameter of outer ring Unit: μm

Nominal bearing outside diameter D (mm)		Deviation of D	
Over	Incl.	High	Low
30	50	—	—
50	80	0	-13
80	120	0	-15
120	150	0	-18
150	180	0	-25
180	250	0	-30
250	315	0	-35
315	400	0	-40
400	500	0	-45
500	630	0	-50
630	800	0	-75

Radial Clearance of Series 5000 Unit: μm

Nominal bearing outside diameter D (mm)		Standard radial clearance	
Over	Incl.	Low	High
70	80	35	70
80	100	40	75
100	125	45	90
125	150	55	105
150	180	65	115
180	240	65	120
240	280	65	130
280	310	70	135
310	340	70	140
340	360	75	150
360	420	90	165
420	460	100	180
460	520	110	195
520	600	125	215
600	650	140	235
650	700	155	275
		180	300

Radial Clearance of Series 4800/4900 Unit: μm

Nominal bearing outside diameter D (mm)		Standard radial clearance	
Over	Incl.	Low	High
70	80	40	75
80	100	40	75
100	125	45	90
125	150	55	105
150	180	65	115
180	240	65	120
240	280	65	130
280	310	70	135
310	340	70	140
340	360	75	150
360	420	90	165
420	500	100	180
		110	195

Sheave Bearings Series 5000

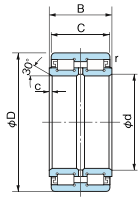

Shield type (E50)

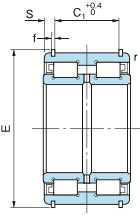

Shield type (E50...NR) with snap rings

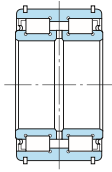

Rubber seal type (E50...NRNT) with snap rings

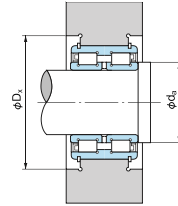

1N=0.102kgf

Boundary dimensions (mm)										Bearing No.			Basic load rating		Limiting speed (min ⁻¹)	Abutment and fillet dimensions (mm)		Mass (kg)
d	D	B	C	r (min)	c	E	C ₁	S	f	Without snap ring with shields	With snap rings with shields	With snap rings and rubber seals	Cr (N)	Cor (N)	Grease lubrication	d _a (min)	D _x (min)	
40	68	38	37	0.6	1.5	71.8	28	4.5	2	E5008	E5008NR	E5008NRNT	79000	125000	2500	46	80	0.57
45	75	40	39	0.6	1.5	78.8	30	4.5	2	E5009	E5009NR	E5009NRNT	95000	144000	2200	51	87	0.71
50	80	40	39	0.6	1.5	83.8	30	4.5	2	E5010	E5010NR	E5010NRNT	99500	158000	2000	56	92	0.77
55	90	46	45	0.6	2	94.8	34	5.5	2.5	E5011	E5011NR	E5011NRNT	117000	193000	1800	63	104	1.18
60	95	46	45	0.6	2	99.8	34	5.5	2.5	E5012	E5012NR	E5012NRNT	123000	208000	1650	68	109	1.26
65	100	46	45	0.6	2	104.8	34	5.5	2.5	E5013	E5013NR	E5013NRNT	128000	224000	1500	73	114	1.34
70	110	54	53	0.6	2	114.5	42	5.5	2.5	E5014	E5014NR	E5014NRNT	170000	285000	1400	78	124	1.91
75	115	54	53	0.6	2	119.5	42	5.5	2.5	E5015	E5015NR	E5015NRNT	177000	305000	1350	83	129	2.01
80	125	60	59	0.6	2	129.5	48	5.5	2.5	E5016	E5016NR	E5016NRNT	250000	430000	1250	88	139	2.71
85	130	60	59	0.6	2	134.5	48	5.5	2.5	E5017	E5017NR	E5017NRNT	255000	445000	1150	93	144	2.85
90	140	67	66	0.6	2.5	145.4	54	6	2.5	E5018	E5018NR	E5018NRNT	305000	540000	1100	100	156	3.81
95	145	67	66	0.6	2.5	150.4	54	6	2.5	E5019	E5019NR	E5019NRNT	310000	560000	1050	105	161	3.97
100	150	67	66	0.6	2.5	155.4	54	6	2.5	E5020	E5020NR	E5020NRNT	315000	585000	1000	110	165	4.14
110	170	80	79	1	3	175.4	65	7	2.5	E5022	E5022NR	E5022NRNT	380000	695000	900	122	186	6.69
120	180	80	79	1	3	188.4	65	7	3	E5024	E5024NR	E5024NRNT	400000	750000	850	132	198	7.24
130	200	95	94	1	3	208.4	77	8.5	3	E5026	E5026NR	E5026NRNT	535000	1000000	750	142	218	10.9
140	210	95	94	1	3	218.4	77	8.5	3	E5028	E5028NR	E5028NRNT	540000	1070000	700	152	228	11.9
150	225	100	99	1	3.5	233.4	81	9	3	E5030	E5030NR	E5030NRNT	620000	1210000	650	164	243	14.0
160	240	109	108	1.5	3.5	248.4	89	9.5	3	E5032	E5032NR	E5032NRNT	715000	1390000	600	174	258	17.1
170	260	122	121	1.5	3.5	270	99	11	4	E5034	E5034NR	E5034NRNT	850000	1730000	600	184	283	23.6
180	280	136	135	1.5	3.5	294	110	12.5	5	E5036	E5036NR	E5036NRNT	1060000	2140000	550	194	311	31.7
190	290	136	135	1.5	3.5	306	110	12.5	5	E5038	E5038NR	E5038NRNT	1110000	2230000	500	204	323	32.8
200	310	150	149	1.5	3.5	326	120	14.5	5	E5040	E5040NR	E5040NRNT	1300000	2650000	500	214	343	42.2
220	340	160	159	1.5	4	356	130	14.5	6	E5044	E5044NR	E5044NRNT	1300000	3100000	450	236	378	54.9
240	360	160	159	1.5	4	376	130	14.5	6	E5048	E5048NR	E5048NRNT	1560000	3350000	400	256	398	58.7
260	400	190	189	2	5	416	154	17.5	6	E5052	E5052NR	E5052NRNT	2110000	4500000	350	280	438	88.1
280	420	190	189	2	5	440	154	17.5	7	E5056	E5056NR	E5056NRNT	2200000	4850000	350	300	462	93.9
300	460	218	216	2	5	480	176	20	8	E5060	—	—	2650000	5850000	350	320	508	134
320	480	218	216	2	5	500	176	20	8	E5064	—	—	2680000	6150000	300	340	528	145
340	520	243	241	2.5	6	544	194	23.5	8	E5068	—	—	3350000	7550000	300	362	577	180

Remark: The bearings must be mounted without a clearance between two separate inner rings.

**Sheave Bearings
Series 5000**

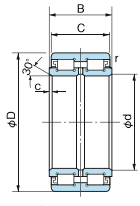

Shield type (E50)

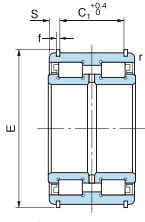

Shield type (E50...NR)
with snap rings

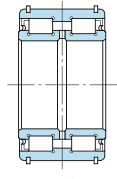

Rubber seal type (E50...NRNT)
with snap rings

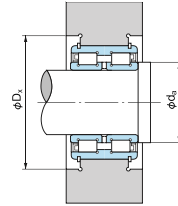

1N=0.102kgf

Boundary dimensions (mm)											Bearing No.			Basic load rating		Limiting speed (min ⁻¹) Grease lubrication	Abutment and fillet dimensions (mm)		Mass (kg)
d	D	B	C	r (min)	c	E	C ₁	S	f	Without snap ring with shields	With snap rings with shields	With snap rings and rubber seals	C _r (N)	C _{or} (N)	d _a (min)		D _x (min)		
360	540	243	241	2.5	6	564	194	23.5	10	E5072	—	—	3400000	7950000	250	382	597	190	
380	560	243	241	2.5	6	584	194	23.5	10	E5076	—	—	3550000	8300000	250	402	617	200	
400	600	272	270	2.5	6	630	210	30	12	E5080	—	—	4220000	10100000	250	422	666	265	
420	620	272	270	2.5	6	650	210	30	12	E5084	—	—	4350000	10500000	230	442	686	275	
440	650	280	278	3	8	680	210	34	12	E5088	—	—	4550000	10900000	220	464	719	310	
460	680	300	298	3	8	710	230	34	12	E5092	—	—	5050000	12100000	200	484	749	365	
480	700	300	298	3	8	730	230	34	12	E5096	—	—	5150000	12500000	200	504	769	380	

Remark: The bearings must be mounted without a clearance between two separate inner rings.

Sheave Bearings
Series 4800/4900

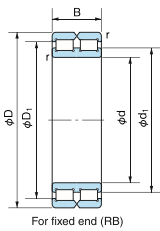

For fixed end (RB)

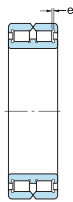

For free end (RC)

1N=0.102kgf

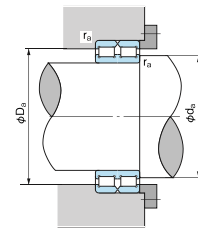

Boundary dimensions (mm)							Bearing No.		Basic load rating		Limiting speed (min ⁻¹)		Abutment and fillet dimensions (mm)			Mass (kg)	Basic No.
d	D	B	d ₁	D ₁	r (min)	e (°)	For fixed end	For free end	Cr (N)	Cor (N)	Grease lubrication	Oil lubrication	d _a (min)	D _a (max)	r _a (max)		
50	72	22	58	63.5	0.6	1	RB4910	RC4910	49000	83000	2000	4000	56	66	0.6	0.30	4910
60	85	25	69.5	76	1	1	RB4912	RC4912	68000	118000	1700	3400	67	78	1	0.46	4912
70	100	30	81.5	88.5	1	1	RB4914	RC4914	105000	193000	1400	2800	77	93	1	0.79	4914
80	110	30	92.5	99.5	1	1	RB4916	RC4916	113000	221000	1250	2500	87	103	1	0.88	4916
90	125	35	103	111.5	1.1	1	RB4918	RC4918	150000	300000	1100	2200	98	117	1	1.37	4918
100	140	40	116	125.5	1.1	1.5	RB4920	RC4920	194000	400000	1000	2000	108	132	1	2.01	4920
110	150	40	124.5	134	1.1	1.5	RB4922	RC4922	202000	430000	900	1800	118	142	1	2.18	4922
120	165	45	138.5	148.5	1.1	2	RB4924	RC4924	226000	560000	850	1700	128	157	1	2.98	4924
130	180	50	148.5	160.5	1.5	2	RB4926	RC4926	262000	555000	750	1500	140	170	1.5	3.97	4926
140	190	50	159	171	1.5	2	RB4928	RC4928	271000	595000	700	1400	150	180	1.5	4.26	4928
150	190	40	164.5	173.5	1.1	1.5	RB4830	RC4830	233000	575000	650	1300	158	182	1	2.90	4830
150	210	60	171.5	186	2	2	RB4930	RC4930	405000	860000	650	1300	161	199	2	6.70	4930
160	200	40	176	185.5	1.1	1.5	RB4832	RC4832	242000	615000	650	1300	168	192	1	3.05	4832
160	220	60	184.5	199.5	2	2	RB4932	RC4932	425000	935000	600	1200	171	209	2	7.03	4932
170	215	45	186	196.5	1.1	2	RB4834	RC4834	264000	650000	600	1200	178	207	1	4.10	4834
170	230	60	193.5	208.5	2	2	RB4934	RC4934	435000	980000	600	1200	181	219	2	7.44	4934
180	225	45	199	209.5	1.1	2	RB4836	RC4836	273000	695000	550	1100	188	217	1	4.30	4836
180	250	69	205.5	223	2	2.5	RB4936	RC4936	550000	1230000	550	1100	191	239	2	11.0	4936
190	240	50	208	220	1.5	2	RB4838	RC4838	315000	785000	550	1100	200	230	1.5	5.65	4838
190	260	69	216	233	2	2.5	RB4938	RC4938	565000	1290000	500	1000	201	249	2	11.5	4938
200	250	50	218.5	230.5	1.5	2	RB4840	RC4840	320000	825000	500	1000	210	240	1.5	5.90	4840
200	280	80	231.5	251	2.1	3	RB4940	RC4940	665000	1500000	500	1000	211	269	2	15.7	4940
220	270	50	239.5	251.5	1.5	2	RB4844	RC4844	335000	905000	450	900	230	260	1.5	6.40	4844
220	300	80	249	268	2.1	3	RB4944	RC4944	695000	1620000	450	900	231	289	2	17.1	4944
240	300	60	260.5	275	2	2	RB4848	RC4848	510000	1330000	400	800	251	289	2	10.2	4848
240	320	80	271.5	291	2.1	3	RB4948	RC4948	725000	1770000	400	800	253	307	2	18.4	4948
260	320	60	283	297.5	2	2	RB4852	RC4852	530000	1450000	400	800	271	309	2	11.0	4852
260	360	100	296	321	2.1	3	RB4952	RC4952	1070000	2570000	350	700	273	347	2	32.0	4952
280	350	69	307.5	325	2	2.5	RB4856	RC4856	680000	1860000	350	700	291	339	2	16.0	4856
280	380	100	318	342.5	2.1	3	RB4956	RC4956	1110000	2780000	350	700	293	367	2	33.9	4956
300	380	80	329	348	2.1	3	RB4860	RC4860	800000	2160000	350	700	313	367	2	23.0	4860
320	400	80	352	371	2.1	3	RB4864	RC4864	830000	2310000	300	600	333	387	2	24.3	4864
340	420	80	368	389	2.1	3	RB4868	RC4868	850000	2430000	300	600	353	407	2	25.6	4868
360	440	80	392	411.5	2.1	3	RB4872	RC4872	880000	2580000	250	500	373	427	2	27.0	4872
380	480	100	419	446	2.1	3	RB4876	RC4876	1290000	3600000	250	500	393	467	2	45.3	4876

Note (°): Axial permissible movement for free end bearing.
Remark: The bearings must be mounted without a clearance between two separate inner rings.



Ball Bearing Units

Ball Bearing Units offer a convenient method of applying highly reliable rolling contact bearings to applications without the necessity of manufacturing a bearing housing.

Generally Ball Bearing Units have following features.

- Self-aligning capability
- Sealed
- Easy to mount and dismount
- Interchangeability with foreign made units

• Many types suitable for applications
Additionally NACHI Ball Bearing Units have the advantages of ease of use and high reliability.

- Anti-rotation pin on outer ring
- Eccentric collar type is also available

• Base for mount locating pin
Since Ball Bearings for units have the same geometry as deep groove ball bearings, load rating, reliability and other functions are equal with that of deep-groove ball bearings.

1. Designations

Number arrangement of Bearing Units and Ball bearings is shown as follows.

(1) Bearing Unit Numbers

C UK P 210 C CT4HR5 +H2310

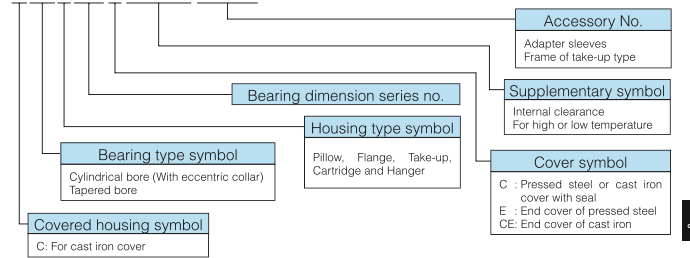

(2) Ball Bearing Numbers

UG 208 C3HR4 +ER

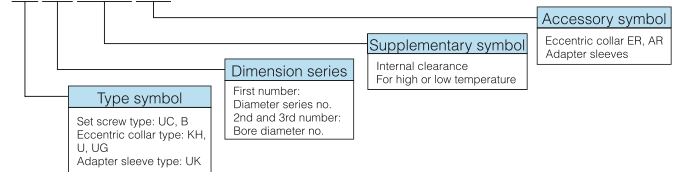

Note: For type B bearings, a last digit of bore diameter number is used as dimension series number.

Contents of dimension tables (1)

Symbol ○: Pressed steel cover type is available. ●: Cast iron cover type is available.

Housing type	Ball bearing type		UC (MUC)	UK+H		B	KH AE	U, MU+ER	UG+ER	Ball bearing type	
			page 527	page 529		page 531	page 531	page 533	page 535		
Cast Iron Series Standard Pillow block Type	P		UCP ○●	UKP ○●		BP	—	—	UGP	P	
Cast Iron Series Thick Body Pillow block for Shock Applications	IP		UCIP ○●	UKIP ○●		—	—	—	—	IP	
Cast Steel Series Pillow block for Heavy Loads	PK		UCPK ●	UKPK ●		—	—	—	—	PK	
Cast Iron Series Pillow block with High Center Height	PH		UCPH	—		—	—	—	—	PH	
Cast Iron Series Pillow block with Small Base	PA		UCPA	—		—	—	—	—	PA	
Cast Iron Series Pillow block for Free-end	EP		UCEP	—		—	—	—	—	EP	
Cast Iron Series Light Weight Pillow block for Light Load	LLP		—	—		BLLP	KHLLP	—	—	LLP	
Stainless Steel Series Standard Pillow block	MP		MUCP	—		—	—	—	—	MP	
Alloy Series (Silver series) Compact Pillow block for Light Load	P (PZ3)		—	—		—	—	UP (MUP) page 447	—	P (PZ3)	
Pressed Steel Series Pillow block for Extremely Light Load	PP		—	—		BPP	KHPP	—	—	PP	
Cast Iron Series Square Flange Type	F		UCF ○●	UKF ○●		BF	—	—	UGF	F	
Cast Iron Series Square Flange with Spigot Joint	FS		UCFS ●	UKFS ●		—	—	—	—	FS	
Cast Iron Series Round Flange Type	FC		UCFC ○●	UKFC ○●		BFC	—	—	UGFC	FC	

Contents of dimension tables (2)

Symbol ○: Pressed steel cover type is available. ●: Cast iron cover type is available.

Housing type	Ball bearing type		UC (MUC)	UK+H		B	KH AE	U, MU+ER	UG+ER	Ball bearing type	Housing type
Cast Iron Series Rhombic Flange Type	FL		UCFL ○ ● page 477	UKFL ○ ● page 481		BFL page 485	—	—	UGFL page 487	FL	
Cast Iron Series Light Weight Rhombic Flange for Light Load	LFL		—	—		BLFL page 489	KHLFL page 489	—	—	LFL	
Stainless Steel Series Rhombic Flange for Anti-Corrosion	MFL		MUCFL page 491	—		—	—	—	—	MFL	
Alloy Series (Silver Series) Compact Rhombic Flange for Light Load	FL (FLZ3)		—	—		—	—	UFL (MUFL) page 493	—	FL (FLZ3)	
Pressed Steel Series Round Flange for Extremely Light Load	PF		—	—		BPF page 495	KHPF page 495	—	—	PF	
Pressed Steel Series Rhombic Flange for Extremely Light Load	PFL		—	—		BPFL page 497	KHPFL page 497	—	—	PFL	
Cast Iron Series Transformed Rhombic Flange, Adjustable Center	FA		UCFA page 499	—		—	—	—	—	FA	
Cast Iron Series One Side Flange Type	FK		UCFK page 501	—		—	—	—	—	FK	
Cast Iron Series Standard Take-Up Type	T		UCT ○ ● page 503	UKT ○ ● page 507		BT page 511	—	—	—	T	
Cast Iron Series Take-Up Type with Frame of Angle Steel	T + WB		UCT+WB page 513	—		—	—	—	—	T + WB	
Cast Iron Series Take-Up Type with Frame of Light Channel Steel	TL + WL		UCTL+WL page 515	—		—	—	—	—	TL + WL	
Cast Iron Series Take-Up Type with Frame of Channel Steel	TU + WU		UCTU+WU page 517	—		—	—	—	—	TU + WU	
Cast Iron Series Cartridge Type	C		UCC page 521	UKC page 523		—	—	—	—	C	
Cast Iron Series Hanger Type	ECH		UCECH page 525	—		—	—	—	—	ECH	

2. Tolerance

Tolerances for ball bearings and housings are shown as follows.

(1) Ball Bearing Tolerances

Tolerances of inner ring	Cylindrical bore: See Table 1 Tapered bore: See Table 5.7.1 (Page 63) 1/12 taper bore
Tolerances of outer ring	Tolerance class 0 of Table 5.1.2 (Page 55) Note: The lower limit of ΔD_{mp} is not applied within a distance of 1/4 of outer ring width from side faces.
Chamfer dimensions	See Table 2

Table 1. Tolerance of Inner Ring (Cylindrical bore)

Unit: μm

Bore dia. Nominal d (mm)	Single plane mean bore dia. deviation ΔD_{mp}		Bore dia. variation in a single radial plane V_{Dp}		Deviation of a single inner ring width ΔB_s			Radial runout of assembled bearing inner ring K_{ia} (reference)	Deviation of (1) eccentric value of inner ring eccentric face ΔH_s
	Over	Incl.	High	Low	Max	High	Low		
6	10		+12	0	8	0	-120	15	± 100
10	18		+15	0	10	0	-120	15	± 100
18	31.75		+18	0	12	0	-120	18	± 100
31.75	50.8		+21	0	14	0	-120	20	± 100
50.8	80		+24	0	16	0	-150	25	± 100
80	120		+28	0	19	0	-200	30	—
120	180		+33	0	22	0	-250	35	—

Note: (1) This deviation is used on the eccentric locking collar type bearings.

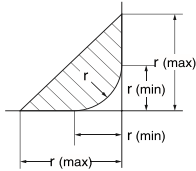

Remark: The exact shape of the chamfer is not specified, but its contour will be in the area shown with oblique lines.

Table 2. Chamfer dimension Limits

Chamfer dimension Nominal r	r		Corner of shaft R
	Max	Min	Max
0.5	0.8	0.3	0.3
1	1.5	0.6	0.6
1.5	2	1	1
2	2.5	1.5	1
2.5	3	2	1.5
3	3.5	2.5	2
3.5	4	2.5	2
4	4.5	3	2.5
5	6	4	3

(2) Bearing Unit Housing Tolerances

Spherical bearing seating of cast iron housing	See Table 3
Others	See NACHI Bearing Units Catalog

Table 3. Tolerance of cast iron housing

Unit: μm

Spherical bearing seating diameter nominal D_a (mm)	Tolerance symbol H7			Tolerance symbol J7			Tolerance symbol K7			
	Deviation of single plane mean dia. of bearing seating ΔD_{am}	Bearing seating dia. variation in a single radial plane V_{Dsp}	Max	Deviation of single plane mean dia. of bearing seating ΔD_{am}	Bearing seating dia. variation in a single radial plane V_{Dsp}	Max	Deviation of single plane mean dia. of bearing seating ΔD_{am}	Bearing seating dia. variation in a single radial plane V_{Dsp}	Max	
Over	Incl.	High	Low	Max	High	Low	Max	High	Low	Max
30	50	+25	0	10	+14	-11	10	+7	-18	10
50	80	+30	0	12	+18	-12	12	+9	-21	12
80	120	+35	0	14	+22	-13	14	+10	-25	14
120	180	+40	0	16	+26	-14	16	+12	-28	16
180	250	+46	0	18	+30	-16	18	+13	-33	18
250	315	+52	0	20	+36	-16	20	+16	-36	20

Notes: 1 Spherical bearing seat dimensions are divided into H7 for clearance fits and J7 and K7 for light interference fits. As NACHI bearings equipped with an anti-rotation pin to prevent outer race rotation, H7 is NACHI standard for the dimension.
2 For rotating outer ring load or fluctuating load applications, J7 or K7 fitting practice should be used.
3 Silver series of special alloy material are supplied with special tolerance.

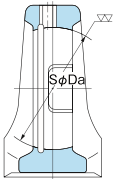

3. Radial clearance of Ball Bearings

Cylindrical bore	See Table 6.1 (page 64); Radial internal clearance of deep-groove ball bearings (with cylindrical bore)
Tapered bore	CT2: CN for cylindrical bore CTN: C3 for cylindrical bore CT3: C4 for cylindrical bore They are considered the inner ring expansion by fitting with an adaptor sleeve.

4. Shaft Tolerance

For cylindrical bore bearings	<ul style="list-style-type: none"> Normal load: Shaft tolerance h7, h8 or js7 Heavy or shock load: Shaft tolerance k6, k7 or m6
For tapered bore bearings with an adaptor sleeve	<ul style="list-style-type: none"> Shaft tolerance h9

5. Maximum permissible misalignment angle

Normal permissible misalignment angle α is $\pm 1.5^\circ \sim 2.5^\circ$ because it is restricted by grease supply. Even if grease is not supplied, it is desirable to use the same limiting value. If larger angles are needed, its angle is permissible to about $\pm 5^\circ$. The maximum misalignment angle of bearing units with a housing cover is $\pm 1.0^\circ \sim 1.8^\circ$, beyond this angle the inner diameter of the cover will interfere the shaft. To prevent the unequal contact between seals and shaft, excessive heat generation and dust intrusion, the misalignment angle should be minimized.

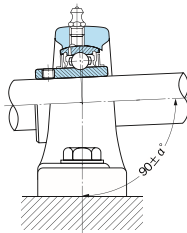

6. Maximum permissible operating temperature

Since Bearing units are sometimes used at higher or lower temperature than normal, NACHI prepares the special specification shown in Table 4. In case of Bearing units with high temperature specification, the decrease in basic load rating should be considered, and radial clearance should be larger than normal clearance. NACHI standard radial clearance for high temperature applications is C3 HR4, C4 HR5 and C4 HR23 for cylindrical bore bearings and CT3 HR4, CT4 HR23 for tapered bore

bearings. If there is a large temperature difference between the inner ring and outer ring, radial internal clearance should be determined reasonably.

Notes 1. If operating temperature exceeds 150°C, careful investigation, including radial internal clearance is required. In such case, Please consult NACHI with operating conditions.
2. The grease shown in Table 4 must be supplied for relubrication, if different greases are mixed, lubrication ability can deteriorate. Before supplying different grease, please consult NACHI or the grease manufactures.

Table 4. Operating Temperature Range

Series	Seal material	Grease	Operating temperature range (°C)	Slinger color
Silver series	Nitrile rubber (NBR)	Alvania Grease 3	- 10 ~ + 80	—
Standard	Nitrile rubber (NBR)	Alvania Grease 3	- 15 ~ +100	Black
HR4 for high temperature	Nitrile rubber (NBR)	Superlube 3	Normal temperature ~ +120	Yellow
HR5 for high temperature	Silicone rubber	Superlube 3	Normal temperature ~ +200	Yellow
HR23 for high temperature	Silicone rubber	Fluorine-contained Grease	Normal temperature ~ +230	Black
CR2A for low temperature	Silicone rubber	Aero Shell Grease 7	- 40 ~ +Normal temperature	White

7. Speed limit

Limiting speed of bearings is determined by the slip speed limit between the seal and inner ring or shaft. Limiting speed of bearings is shown in the chart below. But this limiting speed should be

decreased, if there are differences between shaft center and bearing center or a mixing resistance of grease for HR23 specification. When Bearing units are necessary to operate in excess of speed limit, please consult NACHI.

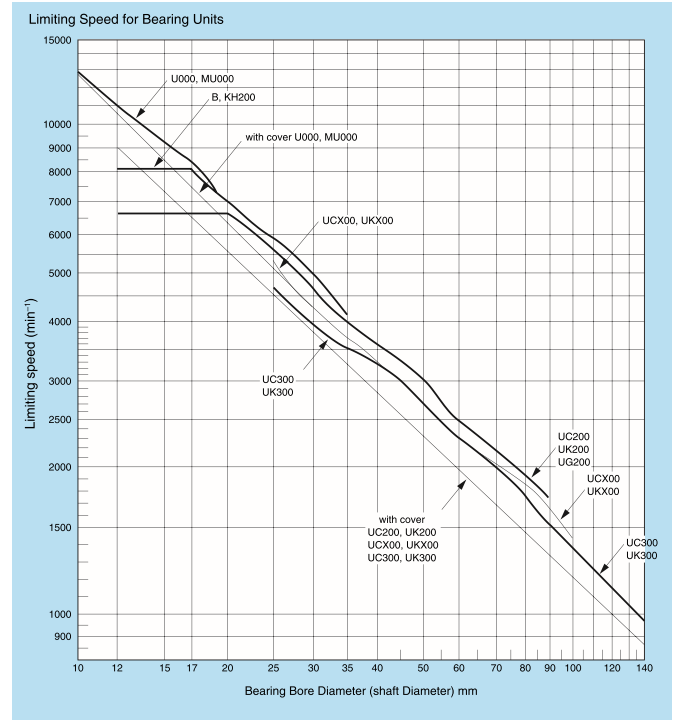

Pillow Block Units
UCP type
With set screws
Cylindrical bore
 Shaft dia.: 12~60mm

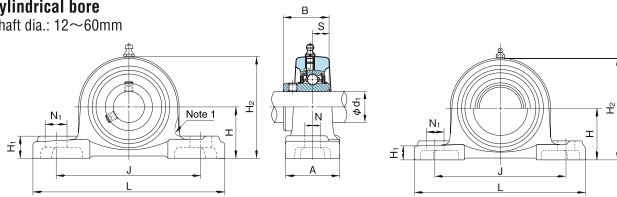

Note: The line shows figure of UCPX00 series

With steel covers

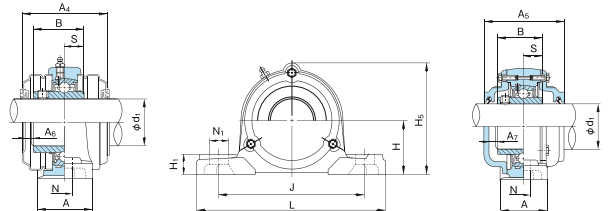

With cast covers

1N=0.102kgf

Shaft dia. d1 (mm)	Unit No.	Boundary dimensions (mm)															Bolt size	Bearings			Housing No.	Unit No. with steel covers		Unit No. with cast covers			Mass of Unit (kg)		
		H	L	A	J	N	N1	H1	H2	Hs	B	S	A4	A5	A6	A7		No.	Basic load rating (N) Cr	Car		Covers with rubber seal (End cover on one side)	Covers with rubber seal (End cover on one side)	standard	with steel cover	with cast covers			
12	UCP201	30.2	127	38	95	13	19	15	62	66	31	12.7	56	62	8	6	M10	UC201	12800	6600	P203	UCP201(C)	CUCP201(C)	0.65	0.71	1.1			
15	UCP202	30.2	127	38	95	13	19	15	62	66	31	12.7	56	62	8	6	M10	UC202	12800	6600	P203	UCP202(C)	CUCP202(C)	0.63	0.69	1.1			
17	UCP203	30.2	127	38	95	13	19	15	62	66	31	12.7	56	62	8	6	M10	UC203	12800	6600	P203	UCP203(C)	CUCP203(C)	0.62	0.68	1.1			
20	UCP204	33.3	127	38	95	13	19	15	65	69	31	12.7	56	62	8	6	M10	UC204	12800	6600	P204	UCP204(C)	CUCP204(C)	0.65	0.71	1.1			
25	UCP205	36.5	140	38	105	13	16	16	70	76	34	14.3	63	70	11	9	M10	UC205	14000	7900	P205	UCP205(C)	CUCP205(C)	0.79	0.86	1.4			
	UCPX05	44.4	159	51	119	17	25	18	85	—	38.1	15.9	65	—	9	—	M14	UCX05	19600	11300	PX05	UCPX05(C)	—	1.5	1.5	—			
	UCP305	45	175	45	132	17	20	16	84	89	38	15	—	78	—	10	M14	UC305	21300	10900	P305	—	CUCP305(C)	1.6	—	2.1			
30	UCP206	42.9	165	48	121	17	21	18	83	87	38.1	15.9	65	74	9	8	M14	UC206	19600	11300	P206	UCP206(C)	CUCP206(C)	1.3	1.4	2.0			
	UCPX06	47.6	175	57	127	17	25	20	94	—	42.9	17.5	70	—	8	—	M14	UCX06	25900	15400	PX06	UCPX06(C)	—	1.9	1.9	—			
	UCP306	50	180	50	140	17	20	19	94	99	43	17	—	84	—	10	M14	UC306	26800	15000	P306	—	CUCP306(C)	1.9	—	2.6			
35	UCP207	47.6	167	48	127	17	21	19	94	97	42.9	17.5	70	80	8	8	M14	UC207	25900	15400	P207	UCP207(C)	CUCP207(C)	1.6	1.7	2.5			
	UCPX07	54	203	57	144	17	30	22	105	—	49.2	19	83	—	10	—	M14	UCX07	29300	17900	PX07	UCPX07(C)	—	2.7	2.7	—			
	UCP307	56	210	56	160	17	25	21	105	110	48	19	—	90	—	10	M14	UC307	33500	19200	P307	—	CUCP307(C)	2.7	—	3.4			
40	UCP208	49.2	184	54	137	17	25	19	100	104	49.2	19	82	90	10	8	M14	UC208	29300	17900	P208	UCP208(C)	CUCP208(C)	2.0	2.2	3.0			
	UCPX08	58.7	222	67	156	20	32	26	113	—	49.2	19	82	—	10	—	M16	UCX08	33000	20500	PX08	UCPX08(C)	—	3.5	3.5	—			
	UCP308	60	220	60	170	17	27	23	116	122	52	19	—	100	—	11	M14	UC308	40500	23900	P308	—	CUCP308(C)	3.3	—	4.4			
45	UCP209	54	190	54	146	17	22	20	108	114	49.2	19	82	90	10	8	M14	UC209	33000	20500	P209	UCP209(C)	CUCP209(C)	2.3	2.5	3.4			
	UCPX09	58.7	222	67	156	20	33	26	116	—	51.6	19	87	—	9	—	M16	UCX09	35500	23200	PX09	UCPX09(C)	—	3.5	3.6	—			
	UCP309	67	245	67	190	20	30	25	128	136	57	22	—	106	—	12	M16	UC309	51500	29500	P309	—	CUCP309(C)	4.5	—	5.8			
50	UCP210	57.2	206	60	159	20	25	22	114	120	51.6	19	87	98	9	10	M16	UC210	35500	23200	P210	UCP210(C)	CUCP210(C)	2.7	3.0	4.1			
	UCPX10	63.5	241	73	171	20	36	27	126	—	55.6	22.2	88	—	9	—	M16	UCX10	43000	29400	PX10	UCPX10(C)	—	4.2	4.5	—			
	UCP310	75	275	75	212	20	35	28	143	149	61	22	—	114	—	12	M16	UC310	61500	38200	P310	—	CUCP310(C)	6.2	—	7.6			
55	UCP211	63.5	219	60	171	20	25	22	126	133	55.6	22.2	88	100	9	10	M16	UC211	43000	29400	P211	UCP211(C)	CUCP211(C)	3.3	3.7	5.0			
	UCPX11	69.8	260	79	184	25	36	30	139	—	65.1	25.4	100	—	9	—	M20	UCX11	52500	36100	PX11	UCPX11(C)	—	5.9	6.2	—			
	UCP311	80	310	80	236	20	38	31	154	159	66	25	—	120	—	13	M16	UC311	71500	44800	P311	—	CUCP311(C)	7.7	—	9.6			
60	UCP212	69.8	241	70	184	20	25	25	138	145	65.1	25.4	102	114	10	11	M16	UC212	52500	36100	P212	UCP212(C)	CUCP212(C)	4.7	5.1	6.7			
	UCPX12	76.2	286	83	203	25	41	32	151	—	65.1	25.4	104	—	11	—	M20	UCX12	57500	40000	PX12	UCPX12(C)	—	7.2	7.4	—			
	UCP312	85	330	85	250	25	38	33	165	169	71	26	—	130	—	14	M20	UC312	81500	52000	P312	—	CUCP312(C)	9.3	—	11.0			

Remarks: 1. Grease nipple: 1/4-28UNF

Remarks: 2. Examples of unit numbers with covers:
 With steel cover { Covers with rubber seal on both sides :UCP210C
 An end cover and a cover with rubber seal :UCP210E
 With cast covers { Covers with rubber seal on both sides :CUCP210C
 An end cover and a cover with rubber seal :CUCP210CE

Pillow Block Units

UCP type
With set screws
Cylindrical bore
Shaft dia.: 65~140mm

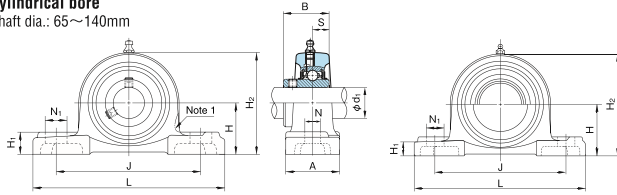

Note: The line shows figure of UCPX00 series

With steel covers

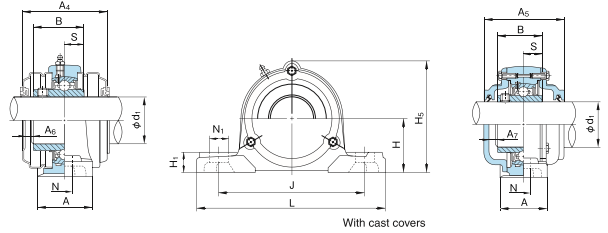

With cast covers

1N=0.102kgf

Shaft dia. (mm)	Unit No.	Boundary dimensions (mm)														Bolt size	Bearings			Housing No.	Unit No. with steel covers		Unit No. with cast covers		Mass of Unit (kg)		
		H	L	A	J	N	N1	H1	H2	Hs	B	S	A4	A5	A6		A7	No.	Basic load rating (N) Cr		Cor	Covers with rubber seal (End cover on one side)	Covers with rubber seal (End cover on one side)	standard	With steel cover	With cast covers	
65	UCP213	76.2	265	70	203	25	29	27	150	156	65.1	25.4	102	118	10	13	M20	UC213	57500	40000	P213	UCP213C(E)	CUCP213C(CE)	5.6	6.1	7.8	
	UCPX13	76.2	286	83	203	25	41	32	154	—	74.6	30.2	—	—	—	—	M20	UCX13	62000	44000	PX13	—	—	7.4	—	—	
	UCP313	90	340	90	260	25	38	36	174	188	75	30	—	140	—	17	M20	UC313	92500	59700	P313	—	CUCP313C(CE)	9.8	—	14.3	
70	UCP214	79.4	266	72	210	25	31	27	156	162	74.6	30.2	—	134	—	16	M20	UC214	62000	44000	P214	—	CUCP214C(CE)	7.3	—	9.3	
	UCPX14	88.9	330	89	229	27	51	35	172	—	77.8	33.3	—	—	—	—	M22	UCX14	66000	48200	PX14	—	—	11.1	—	—	
	UCP314	95	360	90	280	27	40	40	186	198	78	33	—	140	—	17	M22	UC314	104000	68000	P314	—	CUCP314C(CE)	11.4	—	16.7	
75	UCP215	82.6	275	74	217	25	31	28	163	167	77.8	33.3	—	136	—	17	M20	UC215	66000	48200	P215	—	CUCP215C(CE)	7.9	—	9.6	
	UCPX15	88.9	330	89	229	27	51	35	177	—	82.6	33.3	—	—	—	—	M22	UCX15	72500	53000	PX15	—	—	11.4	—	—	
	UCP315	100	380	100	290	27	40	40	197	208	82	32	—	150	—	17	M22	UC315	114000	76900	P315	—	CUCP315C(CE)	13.6	—	19.6	
80	UCP216	88.9	292	78	232	25	31	30	175	188	82.6	33.3	—	146	—	15	M20	UC216	72500	53000	P216	—	CUCP216C(CE)	10.0	—	12.2	
	UCPX16	101.6	381	102	283	27	59	42	197	—	85.7	34.1	—	—	—	—	M22	UCX16	83500	61800	PX16	—	—	17.4	—	—	
	UCP316	106	400	110	300	27	40	45	209	219	86	34	—	154	—	17	M22	UC316	123000	86400	P316	—	CUCP316C(CE)	16.4	—	23.5	
85	UCP217	95.2	310	83	247	25	31	32	187	199	85.7	34.1	—	150	—	15	M20	UC217	83500	61800	P217	—	CUCP217C(CE)	12.2	—	14.2	
	UCPX17	101.6	381	102	283	27	59	42	202	—	96	39.7	—	—	—	—	M22	UCX17	95500	71400	PX17	—	—	17.1	—	—	
	UCP317	112	420	110	320	33	45	45	221	234	96	40	—	164	—	18	M27	UC317	132000	96500	P317	—	CUCP317C(CE)	18.6	—	27.0	
90	UCP218	101.6	327	88	262	27	33	34	200	211	96	39.7	—	164	—	17	M22	UC218	95500	71400	P218	—	CUCP218C(CE)	14.7	—	18.2	
	UCPX18	101.6	381	111	283	27	60	45	206	—	104	42.9	—	—	—	—	M22	UCX18	109000	81600	PX18	—	—	17.0	—	—	
	UCP318	118	430	110	330	33	45	50	233	245	96	40	—	168	—	20	M27	UC318	143000	107200	P318	—	CUCP318C(CE)	20.9	—	30.4	
95	UCP319	125	470	120	360	36	50	50	250	257	103	41	—	180	—	20	M30	UC319	153000	118400	P319	—	CUCP319C(CE)	26.5	—	36.8	
	UCPX20	127	432	121	337	33	64	52	250	—	117.5	49.2	—	—	—	—	M27	UCX20	134000	104700	PX20	—	—	33.0	—	—	
	UCP320	140	490	120	380	36	50	55	275	282	108	42	—	190	—	21	M30	UC320	173000	140400	P320	—	CUCP320C(CE)	34.3	—	44.9	
105	UCP321	140	490	120	380	36	50	55	278	287	112	44	—	194	—	21	M30	UC321	183000	153100	P321	—	CUCP321C(CE)	36.6	—	45.2	
110	UCP322	150	520	140	400	40	55	60	295	305	117	46	—	210	—	26	M33	UC322	205000	178800	P322	—	CUCP322C(CE)	42.5	—	54.7	
120	UCP324	160	570	140	450	40	55	70	321	328	126	51	—	220	—	25	M33	UC324	207000	184800	P324	—	CUCP324C(CE)	53.5	—	73.8	
130	UCP326	180	600	140	480	40	55	80	354	358	135	54	—	230	—	24	M33	UC326	229000	214300	P326	—	CUCP326C(CE)	72.1	—	92.2	
140	UCP328	200	620	140	500	40	55	80	388	388	145	59	—	240	—	24	M33	UC328	255000	246000	P328	—	CUCP328C(CE)	89.1	—	110	

Remarks: 1. Grease nipple: 1/4-28UNF for bore number 13
PF1/8 for bore number 14 and over

Remarks: 2. Examples of unit numbers with covers:
 With steel cover { Covers with rubber seal on both sides :UCP213C
 An end cover and a cover with rubber seal :UCP213E
 With cast covers { Covers with rubber seal on both sides :CUCP213C
 An end cover and a cover with rubber seal :CUCP213CE

Pillow Block Units
UKP+H type
With adapter assembly
Tapered bore
 Shaft dia.: 20~60mm

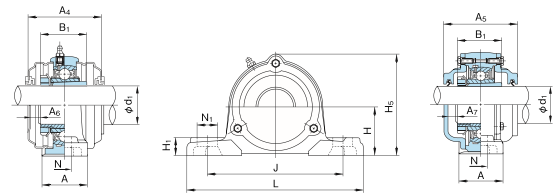
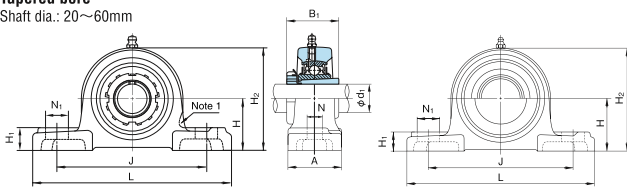

Note: The line shows figure of UCPX00 series

With steel cover

1N=0.102kgf

With cast covers

Shaft dia. d1 (mm)	Unit No.	Boundary dimensions (mm)														Bolt size	Bearings			Unit No. with steel covers		Unit No. with cast covers		Mass of Unit (kg)		
		H	L	A	J	N	N1	H1	H2	Hs	B1	A1	A5	A6	A7		No.	Basic load rating (N) Cr	Cor	Housing No.	Covers with rubber seal (End cover on one side)	Covers with rubber seal (End cover on one side)	standard	with steel cover	with cast covers	
20	UKP205+H2305	36.5	140	38	105	13	16	16	70	76	35	63	70	11	9	M10	UK205+H2305	14000	7900	P205	UKP205(E)+H2305	CUKP205(CE)+H2305	0.84	0.91	1.4	
	UKPX05+H2305	44.4	159	51	119	17	25	18	85	—	35	65	—	10	—	M14	UKX05+H2305	19600	11300	PX05	UKPX05(E)+H2305	—	1.5	1.5	—	
	UKP305+H2305	45	175	45	132	17	20	16	84	89	35	—	78	—	12	M14	UK305+H2305	21300	10900	P305	—	CUKP305(CE)+H2305	1.6	—	2.1	
25	UKP206+H2306	42.9	165	48	121	17	21	18	83	87	38	65	74	10	10	M14	UK206+H2306	19600	11300	P206	UKP206(E)+H2306	CUKP206(CE)+H2306	1.4	1.5	2.1	
	UKPX06+H2306	47.6	175	57	127	17	25	20	94	—	38	70	—	12	—	M14	UKX06+H2306	25900	15400	PX06	UKPX06(E)+H2306	—	2.0	2.0	—	
	UKP306+H2306	50	180	50	140	17	20	19	94	99	38	—	84	—	13	M14	UK306+H2306	26800	15000	P306	—	CUKP306(CE)+H2306	1.9	—	2.6	
30	UKP207+H2307	47.6	167	48	127	17	21	19	94	97	43	70	80	11	11	M14	UK207+H2307	25900	15400	P207	UKP207(E)+H2307	CUKP207(CE)+H2307	1.6	1.8	2.6	
	UKPX07+H2307	54	203	57	144	17	30	22	105	—	43	83	—	17	—	M14	UKX07+H2307	29300	17900	PX07	UKPX07(E)+H2307	—	2.7	2.7	—	
	UKP307+H2307	56	210	56	160	17	25	21	105	110	43	—	90	—	14	M14	UK307+H2307	33500	19200	P307	—	CUKP307(CE)+H2307	2.7	—	3.5	
35	UKP208+H2308	49.2	184	54	137	17	25	19	100	104	46	82	90	15	14	M14	UK208+H2308	29300	17900	P208	UKP208(E)+H2308	CUKP208(CE)+H2308	2.1	2.3	3.1	
	UKPX08+H2308	58.7	222	67	156	20	32	26	113	—	46	82	—	15	—	M16	UKX08+H2308	33000	20500	PX08	UKPX08(E)+H2308	—	3.5	3.5	—	
	UKP308+H2308	60	220	60	170	17	27	23	116	122	46	—	100	—	17	M14	UK308+H2308	40500	23900	P308	—	CUKP308(CE)+H2308	3.0	—	4.4	
40	UKP209+H2309	54	190	54	146	17	22	20	108	114	50	82	90	14	13	M14	UK209+H2309	33000	20500	P209	UKP209(E)+H2309	CUKP209(CE)+H2309	2.4	2.6	3.5	
	UKPX09+H2309	58.7	222	67	156	20	33	26	116	—	50	87	—	16	—	M16	UKX09+H2309	35500	23200	PX09	UKPX09(E)+H2309	—	3.5	3.6	—	
	UKP309+H2309	67	245	67	190	20	30	25	128	136	50	—	106	—	17	M16	UK309+H2309	51500	29500	P309	—	CUKP309(CE)+H2309	4.6	—	5.9	
45	UKP210+H2310	57.2	206	60	159	20	25	22	114	120	55	87	98	15	15	M16	UK210+H2310	35500	23200	P210	UKP210(E)+H2310	CUKP210(CE)+H2310	2.8	3.2	4.2	
	UKPX10+H2310	63.5	241	73	171	20	36	27	126	—	55	88	—	14	—	M16	UKX10+H2310	43000	29400	PX10	UKPX10(E)+H2310	—	4.3	4.5	—	
	UKP310+H2310	75	275	75	212	20	35	28	143	149	55	—	114	—	19	M16	UK310+H2310	61500	38200	P310	—	CUKP310(CE)+H2310	6.2	—	7.8	
50	UKP211+H2311	63.5	219	60	171	20	25	22	126	133	59	88	100	14	15	M16	UK211+H2311	43000	29400	P211	UKP211(E)+H2311	CUKP211(CE)+H2311	3.4	3.8	5.1	
	UKPX11+H2311	69.8	260	79	184	25	36	30	139	—	59	100	—	19	—	M20	UKX11+H2311	52500	36100	PX11	UKPX11(E)+H2311	—	5.8	6.0	—	
	UKP311+H2311	80	310	80	236	20	38	31	154	159	59	—	120	—	20	M16	UK311+H2311	71500	44800	P311	—	CUKP311(CE)+H2311	7.6	—	9.6	
55	UKP212+H2312	69.8	241	70	184	20	25	25	138	145	62	102	114	19	20	M16	UK212+H2312	52500	36100	P212	UKP212(E)+H2312	CUKP212(CE)+H2312	4.8	5.2	6.8	
	UKPX12+H2312	76.2	286	83	203	25	41	32	151	—	62	104	—	19	—	M20	UKX12+H2312	57500	40000	PX12	UKPX12(E)+H2312	—	7.1	7.3	—	
	UKP312+H2312	85	330	85	250	25	38	33	165	169	62	—	130	—	23	M20	UK312+H2312	81500	52000	P312	—	CUKP312(CE)+H2312	9.3	—	11.7	
60	UKP213+H2313	76.2	265	70	203	25	29	27	150	156	65	102	118	17	20	M20	UK213+H2313	57500	40000	P213	UKP213(E)+H2313	CUKP213(CE)+H2313	5.7	6.2	7.9	
	UKPX13+H2313	76.2	286	83	203	25	41	32	154	—	65	—	—	—	—	M20	UKX13+H2313	62000	44000	PX13	—	—	7.2	—	—	
	UKP313+H2313	90	340	90	260	25	38	36	174	188	65	—	140	—	24	M20	UK313+H2313	92500	59700	P313	—	CUKP313(CE)+H2313	9.8	—	14.2	

Remarks: 1. Grease nipple: 1/4-28UNF

Remarks: 2. Examples of unit numbers with covers:

- With steel cover { Covers with rubber seal on both sides :UKP210C+H2310
- { An end cover and a cover with rubber seal :UKP210E+H2310
- With cast covers { Covers with rubber seal on both sides :CUKP210C+H2310
- { An end cover and a cover with rubber seal :CUKP210CE+H2310

Pillow Block Units
UKP+H type
 With adapter assembly
 Tapered bore
 Shaft dia.: 65~125mm

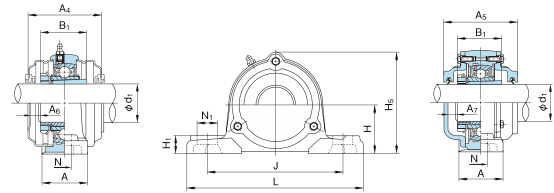
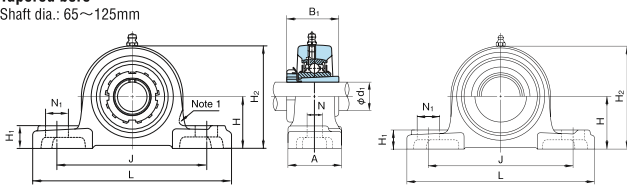

Note: The line shows figure of UCPX00 series

With steel cover

With cast covers

1N=0.102kgf

Shaft dia. d1 (mm)	Unit No.	Boundary dimensions (mm)															Bolt size	Bearings			Housing No.	Unit No. with steel covers		Unit No. with cast covers		Mass of Unit (kg)		
		H	L	A	J	N	N1	H1	H2	H3	B1	A4	A5	A6	A7	No.		Basic load rating (N)	Cr	Cor		Covers with rubber seal (End cover on one side)	Covers with rubber seal (End cover on one side)	standard	with steel cover	with cast covers		
65	UKP215+H2315	82.6	275	74	217	25	31	28	163	167	73	—	136	—	26	M20	UK215+H2315	66000	48200	P215	—	—	CUKP215C(CE)+H2315	8.3	—	10.0		
	UKPX15+H2315	88.9	330	89	229	27	51	35	177	—	73	—	—	—	—	M22	UKX15+H2315	72500	53000	PX15	—	—	—	11.5	—	—		
	UKP315+H2315	100	380	100	290	27	40	40	197	208	73	—	150	—	25	M22	UK315+H2315	114000	76900	P315	—	—	CUKP315C(CE)+H2315	13.7	—	19.9		
70	UKP216+H2316	88.9	292	78	232	25	31	30	175	188	78	—	146	—	26	M20	UK216+H2316	72500	53000	P216	—	—	CUKP216C(CE)+H2316	10.4	—	12.7		
	UKPX16+H2316	101.6	381	102	283	27	59	42	197	—	78	—	—	—	—	M22	UKX16+H2316	83500	61800	PX16	—	—	—	17.4	—	—		
	UKP316+H2316	106	400	110	300	27	40	45	209	219	78	—	154	—	23	M22	UK316+H2316	123000	86400	P316	—	—	CUKP316C(CE)+H2316	16.6	—	23.9		
75	UKP217+H2317	95.2	310	83	247	25	31	32	187	199	82	—	150	—	26	M20	UK217+H2317	83500	61800	P217	—	—	—	12.8	—	14.8		
	UKPX17+H2317	101.6	381	102	283	27	59	42	202	—	82	—	—	—	—	M22	UKX17+H2317	95500	71400	PX17	—	—	—	17.0	—	—		
	UKP317+H2317	112	420	110	320	33	45	45	221	234	82	—	164	—	26	M27	UK317+H2317	132000	96500	P317	—	—	CUKP317C(CE)+H2317	18.6	—	27.1		
80	UKP218+H2318	101.6	327	88	262	27	33	34	200	211	86	—	164	—	31	M22	UK218+H2318	95500	71400	P218	—	—	CUKP218C(CE)+H2318	15.1	—	18.6		
	UKPX18+H2318	101.6	381	111	283	27	60	45	206	—	86	—	—	—	—	M22	UKX18+H2318	109000	81600	PX18	—	—	—	16.7	—	—		
	UKP318+H2318	118	430	110	330	33	45	50	233	245	86	—	168	—	26	M27	UK318+H2318	143000	107200	P318	—	—	CUKP318C(CE)+H2318	21.1	—	30.9		
85	UKP319+H2319	125	470	120	360	36	50	50	250	257	90	—	180	—	30	M30	UK319+H2319	153000	118400	P319	—	—	CUKP319C(CE)+H2319	26.5	—	37.1		
	UKP220+H2320	127	432	121	337	33	64	52	250	—	97	—	—	—	—	M27	UKX20+H2320	134000	104700	PX20	—	—	—	32.1	—	—		
90	UKP320+H2320	140	490	120	380	36	50	55	275	282	97	—	190	—	31	M30	UK320+H2320	173000	140400	P320	—	—	CUKP320C(CE)+H2320	34.3	—	45.2		
	UKP322+H2322	150	520	140	400	40	65	60	295	305	105	—	210	—	36	M33	UK322+H2322	205000	178800	P322	—	—	CUKP322C(CE)+H2322	42.6	—	55.1		
100	UKP324+H2324	160	570	140	450	40	65	70	321	328	112	—	220	—	35	M33	UK324+H2324	207000	184800	P324	—	—	CUKP324C(CE)+H2324	53.0	—	73.8		
	UKP326+H2326	180	600	140	480	40	65	80	354	358	121	—	230	—	36	M33	UK326+H2326	229000	214300	P326	—	—	CUKP326C(CE)+H2326	72.4	—	93.3		
125	UKP328+H2328	200	620	140	500	40	65	80	388	388	131	—	240	—	37	M33	UK328+H2328	255000	246000	P328	—	—	CUKP328C(CE)+H2328	89.4	—	111		

Remarks: 1. Grease nipple: PF1/8

Remarks: 2. Examples of unit numbers with covers:

With cast covers { Covers with rubber seal on both sides :CUKP215C+H2315
 An end cover and a cover with rubber seal :CUKP215CE+H2315

Pillow Block Units

BP type
With set screws
Cylindrical bore
 Shaft dia.: 20~35mm

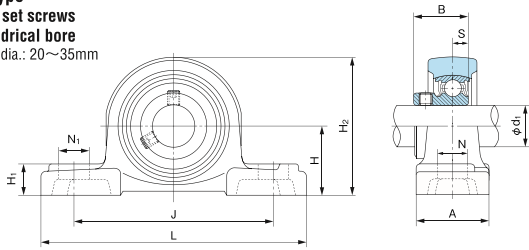

1N=0.102kgf

Shaft dia. d ₁ (mm)	Unit No.	Boundary dimensions (mm)											Bolt size	Bearings			Housing No.	Mass of Unit (kg)
		H	L	A	J	N	N ₁	H ₁	H ₂	B	S	No.		Basic load rating (N)				
		Cr	Cor															
20	BP204	33.3	127	38	95	13	19	15	65	24.7	7	M10	B4	12800	6600	P204 G00	0.61	
25	BP205	36.5	140	38	105	13	16	16	70	27	7.5	M10	B5	14000	7900	P205 G00	0.76	
30	BP206	42.9	165	48	121	17	21	18	83	30.3	8	M14	B6	19600	11300	P206 G00	1.2	
35	BP207	47.6	167	48	127	17	21	19	94	32.9	8.5	M14	B7	25900	15400	P207 G00	1.6	

■ Pillow Block Units
UGP type
With eccentric collar
Cylindrical bore
 Shaft dia.: 20~60mm

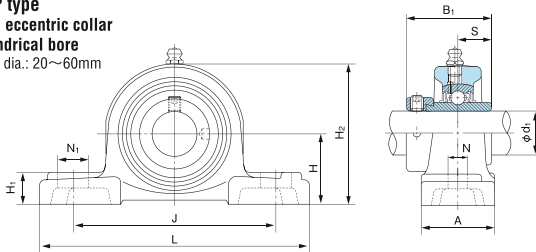

1N=0.102kgf

Shaft dia. d ₁ (mm)	Unit No.	Boundary dimensions (mm)											Bolt size	Bearings			Housing No.	Mass of Unit (kg)
		H	L	A	J	N	N ₁	H ₁	H ₂	B ₁	S	No.		Basic load rating (N)				
		Cr	Cor															
20	UGP204	33.3	127	38	95	13	19	15	65	43.7	17.1	M10	UG204+ER	12800	6600	P204	0.70	
25	UGP205	36.5	140	38	105	13	16	16	70	44.4	17.5	M10	UG205+ER	14000	7900	P205	0.83	
30	UGP206	42.9	165	48	121	17	21	18	83	48.4	18.3	M14	UG206+ER	19600	11300	P206	1.3	
35	UGP207	47.6	167	48	127	17	21	19	94	51.1	18.8	M14	UG207+ER	25900	15400	P207	1.7	
40	UGP208	49.2	184	54	137	17	25	19	100	56.3	21.4	M14	UG208+ER	29300	17900	P208	2.1	
45	UGP209	54	190	54	146	17	22	20	108	56.3	21.4	M14	UG209+ER	33000	20500	P209	2.3	
50	UGP210	57.2	206	60	159	20	25	22	114	62.7	24.6	M16	UG210+ER	35500	23200	P210	2.7	
55	UGP211	63.5	219	60	171	20	25	22	126	71.4	27.8	M16	UG211+ER	43000	29400	P211	3.5	
60	UGP212	69.8	241	70	184	20	25	25	138	77.8	31	M16	UG212+ER	52500	36100	P212	5.0	

Remark: Grease nipple: 1/4-28UNF

Pillow Block Units
UCIP type
With set screws
Cylindrical bore
 Shaft dia.: 40~140mm

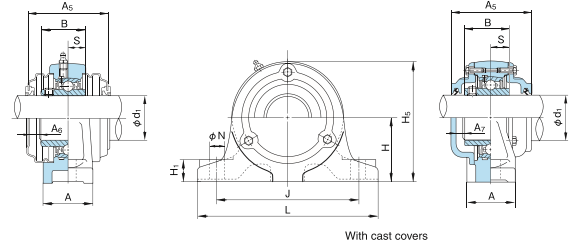
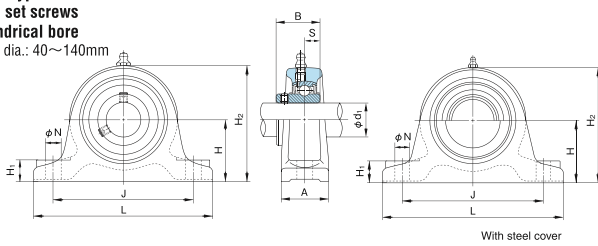

Shaft dia. d ₁ (mm)	Unit No.	Boundary dimensions (mm)														Bolt size	Bearings			Housing No.	Unit No. with steel covers		Unit No. with cast covers		Mass of Unit (kg)										
		H	L	A	J	N	H ₁	H ₂	H ₃	B	S	A ₁	A ₂	A ₃	A ₄		No.	Basic load rating (N)			Covers with rubber seal (End cover on one side)	Covers with rubber seal (End cover on one side)	standard	with steel cover	With cast covers										
		Cr	Cor	UCIP208C(E)	CUCIP208C(CE)	UCIP209C(E)	CUCIP209C(CE)	UCIP210C(E)	CUCIP210C(CE)	UCIP211C(E)	CUCIP211C(CE)	UCIP212C(E)	CUCIP212C(CE)	UCIP213C(E)	CUCIP213C(CE)		UCIP314C(E)	CUCIP314C(CE)	UCIP315C(E)		CUCIP315C(CE)	UCIP316C(E)	CUCIP316C(CE)	UCIP317C(E)	CUCIP317C(CE)	UCIP318C(E)	CUCIP318C(CE)	UCIP319C(E)	CUCIP319C(CE)	UCIP320C(E)	CUCIP320C(CE)	UCIP322C(E)	CUCIP322C(CE)	UCIP324C(E)	CUCIP324C(CE)
40	UCIP208	60	200	60	150	19	25	115	115	49.2	19	86	90	12	8	M16	UC208	29300	17900	IP208	UCIP208C(E)	CUCIP208C(CE)	3.6	3.8	4.0										
45	UCIP209	70	210	60	160	19	25	128	130	49.2	19	92	90	15	8	M16	UC209	33000	20500	IP209	UCIP209C(E)	CUCIP209C(CE)	3.8	4.1	4.5										
50	UCIP210	70	220	60	170	19	28	132	133	51.6	19	92	98	12	10	M16	UC210	35500	23200	IP210	UCIP210C(E)	CUCIP210C(CE)	4.4	4.7	5.0										
55	UCIP211	80	230	60	180	19	28	148	150	55.6	22.2	97	100	14	10	M16	UC211	43000	29400	IP211	UCIP211C(E)	CUCIP211C(CE)	5.5	5.8	6.2										
60	UCIP212	80	260	70	200	22	30	155	155	65.1	25.4	113	114	15	11	M20	UC212	52500	36100	IP212	UCIP212C(E)	CUCIP212C(CE)	5.9	6.3	8.0										
65	UCIP213	90	280	70	220	22	30	172	172	65.1	25.4	111	118	14	13	M20	UC213	57500	40000	IP213	UCIP213C(E)	CUCIP213C(CE)	7.5	8.0	10.1										
70	UCIP313	110	310	70	250	22	30	208	208	75	30	—	140	—	17	M20	UC313	92500	59700	IP313	—	CUCIP313C(CE)	12.4	—	16.5										
70	UCIP314	110	330	75	270	25	35	215	215	78	33	—	140	—	17	M22	UC314	104000	68000	IP314	—	CUCIP314C(CE)	14.9	—	19.2										
75	UCIP315	120	340	75	280	25	35	230	230	82	32	—	150	—	17	M22	UC315	114000	76900	IP315	—	CUCIP315C(CE)	16.2	—	21.8										
80	UCIP316	120	350	85	290	25	40	235	235	86	34	—	154	—	17	M22	UC316	123000	86400	IP316	—	CUCIP316C(CE)	20.8	—	24.8										
85	UCIP317	130	370	85	310	25	40	255	255	96	40	—	164	—	18	M22	UC317	132000	96500	IP317	—	CUCIP317C(CE)	23.1	—	29.4										
90	UCIP318	130	400	85	330	29	45	260	260	96	40	—	168	—	20	M24	UC318	143000	107200	IP318	—	CUCIP318C(CE)	25.7	—	33.2										
95	UCIP319	150	410	85	340	29	45	285	285	103	41	—	180	—	20	M24	UC319	153000	118400	IP319	—	CUCIP319C(CE)	29.7	—	38.5										
100	UCIP320	150	430	85	360	29	45	295	295	108	42	—	190	—	21	M24	UC320	173000	140400	IP320	—	CUCIP320C(CE)	33.4	—	44.2										
110	UCIP322	170	490	100	410	32	50	335	335	117	46	—	210	—	26	M27	UC322	205000	178800	IP322	—	CUCIP322C(CE)	50.4	—	61.2										
120	UCIP324	170	510	100	430	32	50	345	345	126	51	—	220	—	25	M27	UC324	207000	184800	IP324	—	CUCIP324C(CE)	56.8	—	72.3										
130	UCIP326	200	550	110	470	32	50	390	390	135	54	—	230	—	24	M27	UC326	229000	214300	IP326	—	CUCIP326C(CE)	73.2	—	94.3										
140	UCIP328	200	590	110	500	35	55	400	400	145	59	—	240	—	24	M30	UC328	255000	246000	IP328	—	CUCIP328C(CE)	83.5	—	105										

Remarks: 1. Grease nipple : 1/4-28UNF for bore number 13 and under
 PF1/8 for bore number 14 and over

Remarks: 2. Examples of unit numbers with covers:

- With steel cover { Covers with rubber seal on both sides :UCIP210C
- { An end cover and a cover with rubber seal :UCIP210E
- With cast covers { Covers with rubber seal on both sides :CUCIP210C
- { An end cover and a cover with rubber seal :CUCIP210CE

Pillow Block Units
UKIP+H type
 With adapter assembly
 Tapered bore
 Shaft dia.: 35~125mm

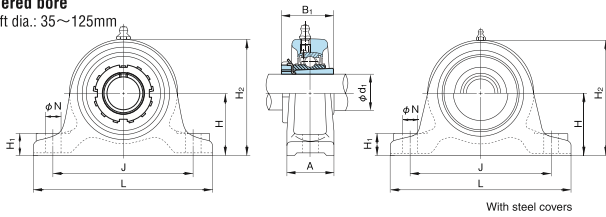

With steel covers

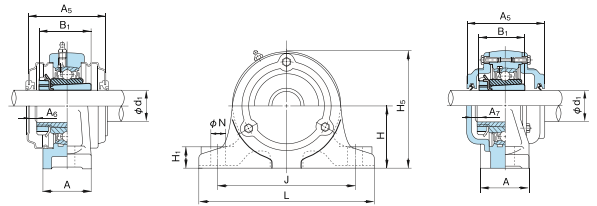

With cast covers

1N=0.102kgf

Shaft dia. d ₁ (mm)	Unit No.	Boundary dimensions (mm)														Bolt size	Bearings			Housing No.	Unit No. with steel covers Covers with rubber seal (End cover on one side)	Unit No. with cast covers Covers with rubber seal (End cover on one side)	Mass of Unit (kg)		
		H	L	A	J	N	H ₁	H ₂	H _s	B ₁	A ₄	A ₅	A ₆	A ₇	No.		Basic load rating (N) C _r	C _{0r}	standard				With steel cover	With cast cover	
35	UKIP208+H2308	60	200	60	150	19	25	115	115	46	86	90	17	14	M16	UK208+H2308	29300	17900	IP208	UKIP208(E)+H2308	CUKIP208(C)(E)+H2308	3.7	3.9	4.1	
40	UKIP209+H2309	70	210	60	160	19	25	128	130	50	92	90	19	13	M16	UK209+H2309	33000	20500	IP209	UKIP209(E)+H2309	CUKIP209(C)(E)+H2309	3.9	4.2	4.7	
45	UKIP210+H2310	70	220	60	170	19	28	132	133	55	92	98	17	15	M16	UK210+H2310	35500	23200	IP210	UKIP210(E)+H2310	CUKIP210(C)(E)+H2310	4.6	4.9	5.2	
50	UKIP211+H2311	80	230	60	180	19	28	148	150	59	97	100	19	15	M16	UK211+H2311	43000	29400	IP211	UKIP211(E)+H2311	CUKIP211(C)(E)+H2311	5.6	6.0	6.4	
55	UKIP212+H2312	80	260	70	200	22	30	155	155	62	113	114	24	20	M20	UK212+H2312	52500	36100	IP212	UKIP212(E)+H2312	CUKIP212(C)(E)+H2312	5.9	6.4	8.2	
60	UKIP213+H2313	90	280	70	220	22	30	172	172	65	111	118	21	20	M20	UK213+H2313	57500	40000	IP213	UKIP213(E)+H2313	CUKIP213(C)(E)+H2313	7.7	8.2	10.4	
	UKIP313+H2313	110	310	70	250	22	30	208	208	65	—	140	—	24	M20	UK313+H2313	92500	59700	IP313	—	CUKIP313(C)(E)+H2313	12.4	—	16.5	
65	UKIP315+H2315	120	340	75	280	25	35	230	230	73	—	150	—	25	M22	UK315+H2315	114000	76900	IP315	—	CUKIP315(C)(E)+H2315	16.3	—	22.2	
70	UKIP316+H2316	120	350	85	290	25	40	235	235	78	—	154	—	23	M22	UK316+H2316	123000	86400	IP316	—	CUKIP316(C)(E)+H2316	21.0	—	25.2	
75	UKIP317+H2317	130	370	85	310	25	40	255	255	82	—	164	—	26	M22	UK317+H2317	132000	96500	IP317	—	CUKIP317(C)(E)+H2317	23.1	—	29.6	
80	UKIP318+H2318	130	400	85	330	29	45	260	260	86	—	168	—	26	M24	UK318+H2318	143000	107200	IP318	—	CUKIP318(C)(E)+H2318	25.9	—	34.2	
85	UKIP319+H2319	150	410	85	340	29	45	285	285	90	—	180	—	30	M24	UK319+H2319	153000	118400	IP319	—	CUKIP319(C)(E)+H2319	29.7	—	38.7	
90	UKIP320+H2320	150	430	85	360	29	45	295	295	97	—	190	—	31	M24	UK320+H2320	173000	140400	IP320	—	CUKIP320(C)(E)+H2320	33.4	—	44.8	
100	UKIP322+H2322	170	490	100	410	32	50	335	335	105	—	210	—	36	M27	UK322+H2322	205000	178800	IP322	—	CUKIP322(C)(E)+H2322	50.5	—	61.9	
110	UKIP324+H2324	170	510	100	430	32	50	345	345	112	—	220	—	35	M27	UK324+H2324	207000	184800	IP324	—	CUKIP324(C)(E)+H2324	56.3	—	72.5	
115	UKIP326+H2326	200	550	110	470	32	50	390	390	121	—	230	—	36	M27	UK326+H2326	229000	214300	IP326	—	CUKIP326(C)(E)+H2326	73.5	—	95.8	
125	UKIP328+H2328	200	590	110	500	35	55	400	400	131	—	240	—	37	M30	UK328+H2328	255000	246000	IP328	—	CUKIP328(C)(E)+H2328	83.8	—	106	

Remarks: 1. Grease nipple: 1/4-28UNF for bore number 13 and under
 PF1/8 for bore number 14 and over

Remarks: 2. Examples of unit numbers with covers:
 With steel cover { Covers with rubber seal on both sides :UKIP210C+H2310
 An end cover and a cover with rubber seal :CUKIP210CE+H2310
 With cast cover { Covers with rubber seal on both sides :CUKIP210C+H2310
 An end cover and a cover with rubber seal :CUKIP210CE+H2310

Cast Steel Pillow Block Units

UCPK type

With set screws

Cylindrical bore

Shaft dia.: 50~140mm

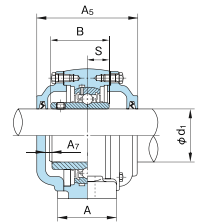
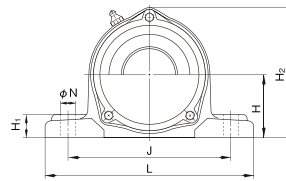
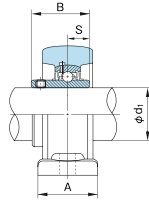
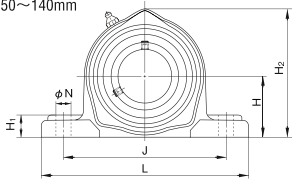

With cast cover

1N=0.102kgf

Shaft dia. d ₁ (mm)	Unit No.	Boundary dimensions (mm)											Bolt size	Bearings			Housing No.	Unit No. with cast covers		Mass of Unit (kg)	
		H	L	A	J	N	H ₁	H ₂	B	S	A ₅	A ₇		No.	Basic load rating (N)			Covers with rubber seal (End cover on one side)	standard	with cast cover	
		Cr	Cor																		
50	<i>UCPK210</i>	57.2	200	55	159	19	22	120	51.6	19	98	10	M16	<i>UC210</i>	35500	23200	<i>PK210</i>	<i>CUCPK210C(CE)</i>	3.5	4.4	
55	<i>UCPK211</i>	63.5	216	55	171	19	22	133	55.6	22.2	100	10	M16	<i>UC211</i>	43000	29400	<i>PK211</i>	<i>CUCPK211C(CE)</i>	4.5	5.7	
60	<i>UCPK212</i>	69.8	233	65	184	19	25	145	65.1	25.4	114	11	M16	<i>UC212</i>	52500	36100	<i>PK212</i>	<i>CUCPK212C(CE)</i>	5.7	6.8	
65	<i>UCPK213</i>	76.2	258	70	203	24	27	156	65.1	25.4	118	13	M20	<i>UC213</i>	40000	40000	<i>PK213</i>	<i>CUCPK213C(CE)</i>	6.7	8.2	
	<i>UCPK313</i>	90	326	85	260	24	36	188	75	30	140	17	M20	<i>UC313</i>	92500	59700	<i>PK313</i>	<i>CUCPK313C(CE)</i>	12.2	14.6	
70	<i>UCPK214</i>	79.4	266	72	210	24	27	162	74.6	30.2	134	16	M20	<i>UC214</i>	62000	44000	<i>PK214</i>	<i>CUCPK214C(CE)</i>	7.6	9.4	
	<i>UCPK314</i>	95	350	85	280	26	40	198	78	33	140	17	M22	<i>UC314</i>	104000	68000	<i>PK314</i>	<i>CUCPK314C(CE)</i>	14.8	17.5	
75	<i>UCPK215</i>	82.6	272	74	217	24	28	167	77.8	33.3	136	17	M20	<i>UC215</i>	66000	48200	<i>PK215</i>	<i>CUCPK215C(CE)</i>	8.1	10.3	
	<i>UCPK315</i>	100	366	90	290	26	40	208	82	32	150	17	M22	<i>UC315</i>	114000	76900	<i>PK315</i>	<i>CUCPK315C(CE)</i>	17.0	20.0	
80	<i>UCPK216</i>	88.9	288	75	232	24	30	188	82.6	33.3	146	15	M20	<i>UC216</i>	72500	53000	<i>PK216</i>	<i>CUCPK216C(CE)</i>	10.4	13.3	
	<i>UCPK316</i>	106	386	100	300	26	45	219	86	34	154	17	M22	<i>UC316</i>	123000	86400	<i>PK316</i>	<i>CUCPK316C(CE)</i>	19.7	23.4	
85	<i>UCPK217</i>	95.2	303	80	247	24	32	199	85.7	34.1	150	15	M20	<i>UC217</i>	83500	61800	<i>PK217</i>	<i>CUCPK217C(CE)</i>	12.2	15.4	
	<i>UCPK317</i>	112	407	105	320	32	45	234	96	40	164	18	M27	<i>UC317</i>	132000	96500	<i>PK317</i>	<i>CUCPK317C(CE)</i>	22.9	27.3	
90	<i>UCPK218</i>	101.6	322	85	262	26	34	211	96	39.7	164	17	M22	<i>UC218</i>	95500	71400	<i>PK218</i>	<i>CUCPK218C(CE)</i>	15.2	18.9	
	<i>UCPK318</i>	118	417	105	330	32	50	245	96	40	168	20	M27	<i>UC318</i>	143000	107200	<i>PK318</i>	<i>CUCPK318C(CE)</i>	25.9	30.8	
95	<i>UCPK319</i>	125	455	115	360	35	50	257	103	41	180	20	M30	<i>UC319</i>	153000	118400	<i>PK319</i>	<i>CUCPK319C(CE)</i>	33.1	38.4	
100	<i>UCPK320</i>	140	475	115	380	35	55	282	108	42	190	21	M30	<i>UC320</i>	173000	140400	<i>PK320</i>	<i>CUCPK320C(CE)</i>	40.2	46.4	
105	<i>UCPK321</i>	140	475	115	380	35	55	287	112	44	194	21	M30	<i>UC321</i>	183000	153100	<i>PK321</i>	<i>CUCPK321C(CE)</i>	40.4	47.4	
110	<i>UCPK322</i>	150	505	130	400	38	60	305	117	46	210	26	M33	<i>UC322</i>	205000	178800	<i>PK322</i>	<i>CUCPK322C(CE)</i>	47.8	55.9	
120	<i>UCPK324</i>	160	555	130	450	38	70	328	126	51	220	25	M33	<i>UC324</i>	207000	184800	<i>PK324</i>	<i>CUCPK324C(CE)</i>	63.8	75.2	
130	<i>UCPK326</i>	180	585	130	480	38	80	358	135	54	230	24	M33	<i>UC326</i>	229000	214300	<i>PK326</i>	<i>CUCPK326C(CE)</i>	81.6	94.4	
140	<i>UCPK328</i>	200	605	130	500	38	80	388	145	59	240	24	M33	<i>UC328</i>	255000	246000	<i>PK328</i>	<i>CUCPK328C(CE)</i>	95.9	110	

Remarks: 1. Please contact NACHI for units number appeared in italic.
 2. Grease nipple: 1/4-28UNF for bore number 13 and under
 PF1/8 for bore number 14 and over

Remarks: 3. Examples of unit numbers with covers:
 With cast cover { Covers with rubber seal on both sides :CUCPK210C
 An end cover and a cover with rubber seal :CUCPK210CE

Cast Steel Pillow Block Units

UKPK+H type
 With adapter assembly
 Tapered bore
 Shaft dia.: 45~125mm



1N=0.102kgf

Shaft dia. d ₁ (mm)	Unit No.	Boundary dimensions (mm)											Bolt size	Bearings			Housing No.	Unit No. with cast covers		Mass of Unit (kg)	
		H	L	A	J	N	H ₁	H ₂	B ₁	A ₅	A ₇	No.		Basic load rating (N)		Both covers with rubber seal (one side end cover)		standard	with cast cover		
		Cr	Cor																		
45	<i>UKPK210+H2310</i>	57.2	200	55	159	19	22	120	55	98	15	M16	<i>UK210+H2310</i>	35500	23200	PK210	<i>CUKPK210C(CE)+H2310</i>	3.6	4.6		
50	<i>UKPK211+H2311</i>	63.5	216	55	171	19	22	133	59	100	15	M16	<i>UK211+H2311</i>	43000	29400	PK211	<i>CUKPK211C(CE)+H2311</i>	4.7	5.9		
55	<i>UKPK212+H2312</i>	69.8	233	65	184	19	25	145	62	114	20	M16	<i>UK212+H2312</i>	52500	36100	PK212	<i>CUKPK212C(CE)+H2312</i>	5.7	6.9		
60	<i>UKPK213+H2313</i>	76.2	258	70	203	24	27	156	65	118	20	M20	<i>UK213+H2313</i>	57500	40000	PK213	<i>CUKPK213C(CE)+H2313</i>	6.8	8.4		
	<i>UKPK313+H2313</i>	90	326	85	260	24	36	188	65	140	24	M20	<i>UK313+H2313</i>	92500	59700	PK313	<i>CUKPK313C(CE)+H2313</i>	12.1	14.6		
65	<i>UKPK215+H2315</i>	82.6	272	74	217	24	28	167	73	136	26	M20	<i>UK215+H2315</i>	66000	48200	PK215	<i>CUKPK215C(CE)+H2315</i>	8.5	10.7		
	<i>UKPK315+H2315</i>	100	366	90	290	26	40	208	73	150	25	M22	<i>UK315+H2315</i>	114000	76900	PK315	<i>CUKPK315C(CE)+H2315</i>	17.2	20.4		
70	<i>UKPK216+H2316</i>	88.9	288	75	232	24	30	188	78	146	26	M20	<i>UK216+H2316</i>	72500	53000	PK216	<i>CUKPK216C(CE)+H2316</i>	10.9	13.8		
	<i>UKPK316+H2316</i>	106	386	100	300	26	45	219	78	154	23	M22	<i>UK316+H2316</i>	123000	86400	PK316	<i>CUKPK316C(CE)+H2316</i>	20.0	23.7		
75	<i>UKPK217+H2317</i>	95.2	303	80	247	24	32	199	82	150	26	M20	<i>UK217+H2317</i>	83500	61800	PK217	<i>CUKPK217C(CE)+H2317</i>	12.8	16.1		
	<i>UKPK317+H2317</i>	112	407	105	320	32	45	234	82	164	26	M27	<i>UK317+H2317</i>	132000	96500	PK317	<i>CUKPK317C(CE)+H2317</i>	22.9	27.4		
80	<i>UKPK218+H2318</i>	101.6	322	85	262	26	34	211	86	164	31	M22	<i>UK218+H2318</i>	95500	71400	PK218	<i>CUKPK218C(CE)+H2318</i>	15.5	19.4		
	<i>UKPK318+H2318</i>	118	417	105	330	32	50	245	86	168	26	M27	<i>UK318+H2318</i>	143000	107200	PK318	<i>CUKPK318C(CE)+H2318</i>	26.1	31.2		
85	<i>UKPK319+H2319</i>	125	455	115	360	35	50	257	90	180	30	M30	<i>UK319+H2319</i>	153000	118400	PK319	<i>CUKPK319C(CE)+H2319</i>	33.1	38.7		
90	<i>UKPK320+H2320</i>	140	475	115	380	35	55	282	97	190	31	M30	<i>UK320+H2320</i>	173000	140400	PK320	<i>CUKPK320C(CE)+H2320</i>	40.2	46.7		
100	<i>UKPK322+H2322</i>	150	505	130	400	38	60	305	105	210	36	M33	<i>UK322+H2322</i>	205000	178800	PK322	<i>CUKPK322C(CE)+H2322</i>	47.9	56.5		
110	<i>UKPK324+H2324</i>	160	555	130	450	38	70	328	112	220	35	M33	<i>UK324+H2324</i>	207000	184800	PK324	<i>CUKPK324C(CE)+H2324</i>	63.3	75.1		
115	<i>UKPK326+H2326</i>	180	585	130	480	38	80	358	121	230	36	M33	<i>UK326+H2326</i>	229000	214300	PK326	<i>CUKPK326C(CE)+H2326</i>	81.9	95.3		
125	<i>UKPK328+H2328</i>	200	605	130	500	38	80	388	131	240	37	M33	<i>UK328+H2328</i>	255000	246000	PK328	<i>CUKPK328C(CE)+H2328</i>	96.2	111		

Remarks: 1. Please contact NACHI for units number appeared in italic.
 2. Grease nipple: 1/4-28UNF for bore number 13 and under
 PF1/8 for bore number 14 and over

Remarks: 3. Examples of unit numbers with covers:
 with cast cover { Covers with rubber seal on both sides :CUKPK210C+H2310
 An end cover and a cover with rubber seal:CUKPK210CE+H2310

Pillow Block Units
UCPH type
With set screws
Cylindrical bore
 Shaft dia.: 12~50mm

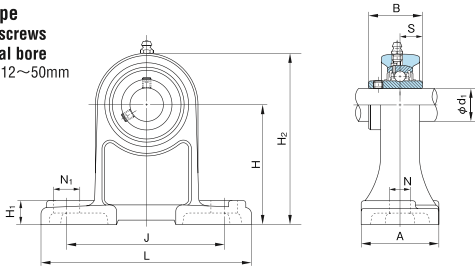

1N=0.102kgf

Shaft dia. d ₁ (mm)	Unit No.	Boundary dimensions (mm)											Bolt size	Bearings			Housing No.	Mass of Unit (kg)
		H	L	A	J	N	N ₁	H ₁	H ₂	B	S	No.		Basic load rating (N)				
		Cr	Cor															
12	UCPH201	70	127	40	95	13	19	15	101	31	12.7	M10	UC201	12800	6600	PH204	1.0	
15	UCPH202	70	127	40	95	13	19	15	101	31	12.7	M10	UC202	12800	6600	PH204	0.99	
17	UCPH203	70	127	40	95	13	19	15	101	31	12.7	M10	UC203	12800	6600	PH204	0.98	
20	UCPH204	70	127	40	95	13	19	15	101	31	12.7	M10	UC204	12800	6600	PH204	0.96	
25	UCPH205	80	140	50	105	13	19	16	114	34	14.3	M10	UC205	14000	7900	PH205	1.2	
30	UCPH206	90	165	50	121	17	21	18	130	38.1	15.9	M14	UC206	19600	11300	PH206	1.9	
35	UCPH207	95	167	60	127	17	21	19	140	42.9	17.5	M14	UC207	25900	15400	PH207	2.4	
40	UCPH208	100	184	70	137	17	25	19	149	49.2	19	M14	UC208	29300	17900	PH208	2.8	
45	UCPH209	105	190	70	146	17	25	20	157	49.2	19	M14	UC209	33000	20500	PH209	3.2	
50	UCPH210	110	206	70	159	20	25	22	165	51.6	19	M16	UC210	35500	23200	PH210	3.6	

Remark: Grease nipple :1/4-28UNF

Pillow Block Units

UCPA type

With set screws

Cylindrical bore

Shaft dia.: 12~50mm

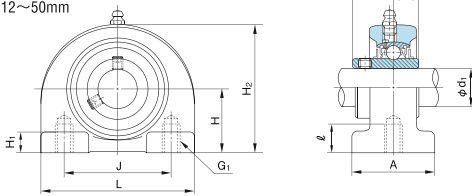

1N=0.102kgf

Shaft dia. d ₁ (mm)	Unit No.	Boundary dimensions (mm)										Bearings			Housing No.	Mass of Unit (kg)
		H	L	A	J	G ₁	ℓ	H ₁	H ₂	B	S	No.	Basic load rating (N)			
		Cr	Cor													
12	UCPA201	30.2	76	38	52	M10×1.5	12	8	62	31	12.7	UC201	12800	6600	PA204	0.59
15	UCPA202	30.2	76	38	52	M10×1.5	12	8	62	31	12.7	UC202	12800	6600	PA204	0.57
17	UCPA203	30.2	76	38	52	M10×1.5	12	8	62	31	12.7	UC203	12800	6600	PA204	0.56
20	UCPA204	30.2	76	38	52	M10×1.5	12	8	62	31	12.7	UC204	12800	6600	PA204	0.54
25	UCPA205	36.5	84	38	56	M10×1.5	15	10	72	34	14.3	UC205	14000	7900	PA205	0.73
30	UCPA206	42.9	94	48	66	M14×2	18	10	84	38.1	15.9	UC206	19600	11300	PA206	1.11
35	UCPA207	47.6	110	48	80	M14×2	20	12	95	42.9	17.5	UC207	25900	15400	PA207	1.63
40	UCPA208	49.2	116	54	84	M14×2	20	12	100	49.2	19	UC208	29300	17900	PA208	1.85
45	UCPA209	54.2	120	54	90	M14×2	25	12	108	49.2	19	UC209	33000	20500	PA209	2.11
50	UCPA210	57.2	130	60	94	M16×2	25	14	116	51.6	19	UC210	35500	23200	PA210	2.52

Remark: Grease nipple: 1/4-28UNF

Pillow Block Units
UCEP type
With set screws
Cylindrical bore
 Shaft dia.: 20~85mm

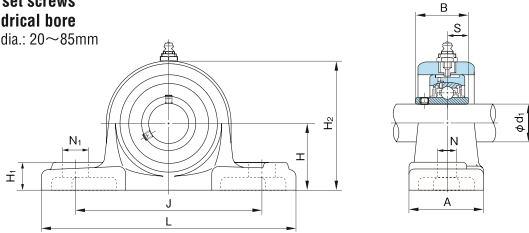

1N=0.102kgf

Shaft dia. d ₁ (mm)	Unit No.	Boundary dimensions (mm)											Axial displacement (mm)	Bolt size	Bearings				Housing No.		Mass of Unit (kg)
		H	L	A	J	N	N ₁	H ₁	H ₂	B	S	No.			Basic load rating (N)		Pillow type Housing	Cartridge type Housing			
		Cr	Cor																		
20	UCEP204	36.5	140	38	105	13	16	16	73	31	12.7	10	M10	UC204	12800	6600	EP204	EC204	1.1		
25	UCEP205	44.4	159	51	119	17	20	18	85	34	14.3	10	M14	UC205	14000	7900	EP205	EC205	1.5		
30	UCEP206	47.6	175	57	127	17	20	20	94	38.1	15.9	10	M14	UC206	19600	11300	EP206	EC206	2.0		
35	UCEP207	54	203	57	144	17	20	22	108	42.9	17.5	10	M14	UC207	25900	15400	EP207	EC207	2.7		
40	UCEP208	58.7	222	67	156	20	24	26	116	49.2	19	10	M16	UC208	29300	17900	EP209	EC208	3.5		
45	UCEP209	58.7	222	67	156	20	24	26	116	49.2	19	10	M16	UC209	33000	20500	EP209	EC209	3.4		
50	UCEP210	63.5	241	73	171	20	26	27	126	51.6	19	10	M16	UC210	35500	23200	EP210	EC210	4.1		
55	UCEP211	69.8	260	79	184	25	28	30	139	55.6	22.2	10	M20	UC211	43000	29400	EP211	EC211	5.6		
60	UCEP212	76.2	286	83	203	25	30	32	151	65.1	25.4	10	M20	UC212	52500	36100	EP212	EC212	7.1		
65	UCEP213	76.2	286	83	203	25	30	32	154	65.1	25.4	10	M20	UC213	57500	40000	EP213	EC213	7.0		
70	UCEP214	88.9	330	89	229	27	31	35	177	74.6	30.2	10	M22	UC214	62000	44000	EP215	EC214	10.8		
75	UCEP215	88.9	330	89	229	27	31	35	177	77.8	33.3	10	M22	UC215	66000	48200	EP215	EC215	10.9		
80	UCEP216	101.6	381	102	283	27	40	42	205	82.6	33.3	15	M22	UC216	72500	53000	EP217	EC216	17.1		
85	UCEP217	101.6	381	102	283	27	40	42	205	85.7	34.1	15	M22	UC217	83500	61800	EP217	EC217	16.4		

Remarks: 1. This unit allows the movement in axial direction to be used on free side and the mounting dimensions are equal to UCPX00 type.
 2. Grease nipple: 1/4-28UNF for bore number 13 and under
 PF1/8 for bore number 14 and over

Pillow Block Units

BLLP type

With set screws

Cylindrical bore

Shaft dia.: 12~35mm

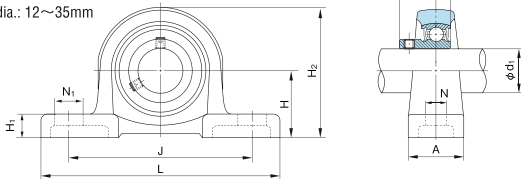

KHLLP type

With eccentric collar

Cylindrical bore

Shaft dia.: 12~35mm

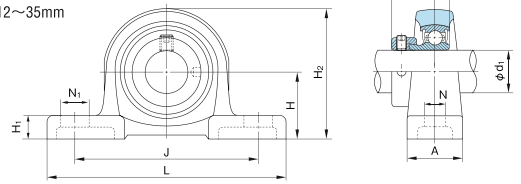

BLLP type

Shaft dia. d ₁ (mm)	Unit No.	Boundary dimensions (mm)										Bolt size	Bearings			Housing No.	Mass of Unit (kg)
		H	L	A	J	N	N ₁	H ₁	H ₂	B	S		No.	Basic load rating (N)			
		Cr	Cor														
12	BLLP1J	30.2	114	25	87	12	16	12	57	22	6	M10	B1	9550	4800	LLP3J	0.39
15	BLLP2J	30.2	114	25	87	12	16	12	57	22	6	M10	B2	9550	4800	LLP3J	0.38
17	BLLP3J	30.2	114	25	87	12	16	12	57	22	6	M10	B3	9550	4800	LLP3J	0.36
20	BLLP4J	33.3	125	27	97	12	16	13	64	24.7	7	M10	B4	12800	6600	LLP4J	0.48
25	BLLP5J	36.5	130	29	100	12	16	13	70	27	7.5	M10	B5	14000	7900	LLP5J	0.59
30	BLLP6J	42.9	156	33	120	14	21	15	83	30.3	8	M12	B6	19600	11300	LLP6J	0.70
35	BLLP7J	47.6	165	35	127	14	21	16	93	32.9	8.5	M12	B7	25900	15400	LLP7J	0.98

Remark: Spherical bearing seating diameter of housing is applied tolerance class J7.

KHLLP type

Shaft dia. d ₁ (mm)	Unit No.	Boundary dimensions (mm)										Bolt size	Bearings			Housing No.	Mass of Unit (kg)
		H	L	A	J	N	N ₁	H ₁	H ₂	B ₁	S		No.	Basic load rating (N)			
		Cr	Cor														
12	KHLLP201AJ	30.2	114	25	87	12	16	12	57	28.6	6.5	M10	KH201AE	9550	4800	LLP3J	0.41
15	KHLLP202AJ	30.2	114	25	87	12	16	12	57	28.6	6.5	M10	KH202AE	9550	4800	LLP3J	0.40
17	KHLLP203AJ	30.2	114	25	87	12	16	12	57	28.6	6.5	M10	KH203AE	9550	4800	LLP3J	0.39
20	KHLLP204AJ	33.3	125	27	97	12	16	13	64	31	7.5	M10	KH204AE	12800	6600	LLP4J	0.52
25	KHLLP205AJ	36.5	130	29	100	12	16	13	70	31	7.5	M10	KH205AE	14000	7900	LLP5J	0.63
30	KHLLP206AJ	42.9	156	33	120	14	21	15	83	35.7	9	M12	KH206AE	19600	11300	LLP6J	0.76
35	KHLLP207AJ	47.6	165	35	127	14	21	16	93	38.9	9.5	M12	KH207AE	25900	15400	LLP7J	1.09

Remark: Spherical bearing seating diameter of housing is applied tolerance class J7.

Pillow Block Units
MUCP type (Stainless Steel)
 With set screws
 Cylindrical bore
 Shaft dia.: 20~50mm

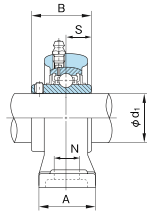
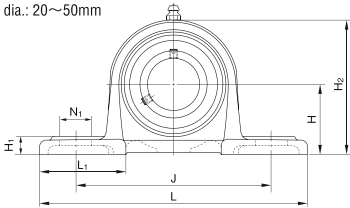

1N=0.102kgf

Shaft dia. d ₁ (mm)	Unit No.	Boundary dimensions (mm)												Bolt size	Bearings			Housing No.	Mass of Unit (kg)
		H	L	A	J	N	N ₁	H ₁	H ₂	L ₁	B	S	No.		Basic load rating (N)				
		Cr	Cor																
20	MUCP204	33.3	127	30	95	13	19	9	64	42	31	12.7	M10	MUC204	10900	5300	MP204	0.50	
25	MUCP205	36.5	140	30	105	13	19	10	70	42	34	14.3	M10	MUC205	11900	6300	MP205	0.65	
30	MUCP206	42.9	165	36	121	17	21	11	82	53	38.1	15.9	M14	MUC206	16700	9050	MP206	0.95	
35	MUCP207	47.6	167	38	127	17	21	12	92	54	42.9	17.5	M14	MUC207	22000	12300	MP207	1.25	
40	MUCP208	49.2	184	40	137	17	22	12	98	52	49.2	19	M14	MUC208	24900	14300	MP208	1.50	
45	MUCP209	54	190	40	146	17	22	13	105	60	49.2	19	M14	MUC209	28100	16400	MP209	1.75	
50	MUCP210	57.2	206	45	159	20	25	14	112	65	51.6	19	M16	MUC210	30200	18600	MP210	2.05	

Remark: Grease nipple: 1/4-28UNF

Silver series

Pillow Block Units

UP type
MUP type (Stainless Silver Series)
With eccentric collar
Cylindrical bore
Shaft dia.: 8~30mm

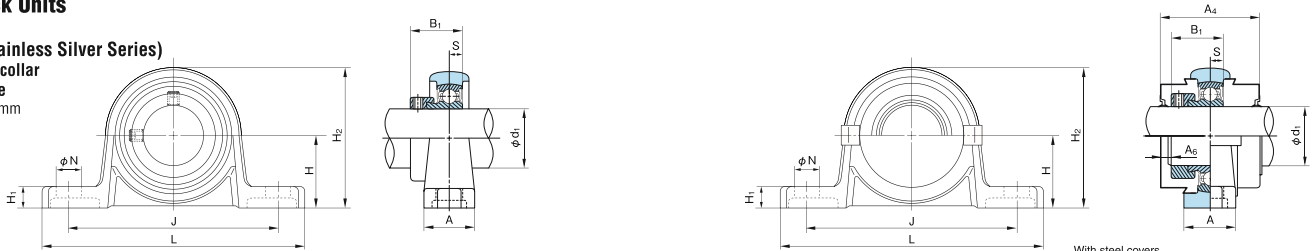

UP type

Shaft dia. d1 (mm)	Unit No.	Boundary dimensions (mm)												Bolt size	Bearings			Housing No.	Unit No. with covers		Cover No. (Reference)			Mass of Unit (kg)	
		H	L	A	J	N	H1	H2	B1	S	A4	A6	No.		Basic load rating (N)	Cr	Cor		Covers with rubber seal (End cover on one side)	Cover with rubber seal	Side end cover	standard	with steel cover		
10	UP000	18	67	16	53	7	6	35	17.5	4	33	2	M 6	U000+ER	4600	2000	P000	UP000C(E)	000CP10	000CPE	77	85			
12	UP001	19	71	16	56	7	6	38	17.5	4	33	2	M 6	U001+ER	5100	2400	P001	UP001C(E)	001CP12	001CPE	91	100			
15	UP002	22	80	16	63	7	7	43	18.5	4.5	34	2	M 6	U002+ER	5600	2800	P002	UP002C(E)	002CP15	002CPE	125	135			
17	UP003	24	85	18	67	7	7	47	20.5	5	38	2	M 6	U003+ER	6000	3300	P003	UP003C(E)	003CP17	003CPE	156	170			
20	UP004	28	100	20	80	10	9	55	24.5	6	46	3	M 8	U004+ER	9350	5100	P04-5	UP004C(E)	04-5CP20	04-5CPE	230	250			
25	UP005	32	112	20	90	10	10	62	25.5	6	47	3	M 8	U005+ER	10100	5800	P05-6	UP005C(E)	05-6CP25	05-6CPE	294	315			
30	UP006	36	132	26	106	13	11	70	26.5	6.5	50	4	M10	U006+ER	13200	8300	P06-7	UP006C(E)	06-7CP30	06-7CPE	454	480			
8	UP08	15	55	13	42	4.8	5	29	15	3.5	-	-	M 4	U08+ER(*)	3300	1260	P08	-	-	-	47	-			

Note: (*) Set screw type U08X is also available and the width of inner ring is 12mm.
Remarks: 1. Please contact NACHI for unit numbers appearing in *italics*.

Remarks: 2. Examples of unit numbers with covers: Covers with rubber seal on both sides :UP005C
An end cover and a cover with rubber seal :UP005E

MUP type (Stainless Silver Series)

Shaft dia. d1 (mm)	Unit No.	Boundary dimensions (mm)												Bolt size	Bearings			Housing No.	Unit No. with covers		Cover No. (Reference)			Mass of Unit (kg)	
		H	L	A	J	N	H1	H2	B1	S	A4	A6	No.		Basic load rating (N)	Cr	Cor		Covers with rubber seal (End cover on one side)	Cover with rubber seal	Side end cover	standard	with steel cover		
10	MUP000	18	67	16	53	7	6	35	17.5	4	33	2	M 6	MU000+ER	3900	1550	P000Z3	MUP000C(E)	000CP10	000CPE	77	85			
12	MUP001	19	71	16	56	7	6	38	17.5	4	33	2	M 6	MU001+ER	4300	1900	P001Z3	MUP001C(E)	001CP12	001CPE	91	100			
15	MUP002	22	80	16	63	7	7	43	18.5	4.5	34	2	M 6	MU002+ER	4750	2250	P002Z3	MUP002C(E)	002CP15	002CPE	125	135			
17	MUP003	24	85	18	67	7	7	47	20.5	5	38	2	M 6	MU003+ER	5100	2650	P003Z3	MUP003C(E)	003CP17	003CPE	156	170			
20	MUP004	28	100	20	80	10	9	55	24.5	6	46	3	M 8	MU004+ER	7900	4000	P04-5Z3	MUP004C(E)	04-5CP20	04-5CPE	230	250			
25	MUP005	32	112	20	90	10	10	62	25.5	6	47	3	M 8	MU005+ER	8600	4650	P05-6Z3	MUP005C(E)	05-6CP25	05-6CPE	294	315			
30	MUP006	36	132	26	106	13	11	70	26.5	6.5	50	4	M10	MU006+ER	11300	6600	P06-7Z3	MUP006C(E)	06-7CP30	06-7CPE	454	480			

Remark: Examples of unit numbers with covers: Covers with rubber seal on both sides :MUP005C
An end cover and a cover with rubber seal :MUP005E

Pressed Steel Pillow Block Units

BPP type
With set screws
Cylindrical bore
Shaft dia.: 12~35mm

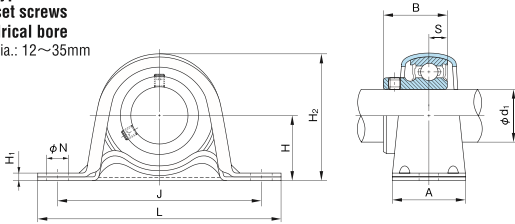

KHPP type
With eccentric collar
Cylindrical bore
Shaft dia.: 12~35mm

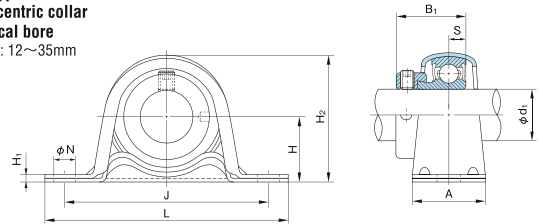

BPP type

Shaft dia. d ₁ (mm)	Unit No.	Boundary dimensions (mm)										Bolt size	Bearings			Housing No.	Mass of Unit (kg)	Limiting load (N)	
		H	L	A	J	N	H ₁	H ₂	B	S	No.		Basic load rating (N)		Radial			Axial	
		Cr		Cor															
1N=0.102kgf																			
12	BPP1	22.2	86	25	68	9.5	3.2	44	22	6	M 8	B1	9550	4800	PP3	0.16	2150	830	
15	BPP2	22.2	86	25	68	9.5	3.2	44	22	6	M 8	B2	9550	4800	PP3	0.15	2150	830	
17	BPP3	22.2	86	25	68	9.5	3.2	44	22	6	M 8	B3	9550	4800	PP3	0.13	2150	830	
20	BPP4	25.4	98	32	76	9.5	3.2	50	24.7	7	M 8	B4	12800	6600	PP4	0.21	2650	1030	
25	BPP5	28.6	108	32	86	11.5	4	56	27	7.5	M10	B5	14000	7900	PP5	0.29	3700	1470	
30	BPP6	33.3	117	38	95	11.5	4	66	30.3	8	M10	B6	19600	11300	PP6	0.42	4400	1670	
35	BPP7	39.7	129	42	106	11.5	4.6	78	32.9	8.5	M10	B7	25900	15400	PP7	0.61	4900	1860	

KHPP type

Shaft dia. d ₁ (mm)	Unit No.	Boundary dimensions (mm)										Bolt size	Bearings			Housing No.	Mass of Unit (kg)	Limiting load (N)	
		H	L	A	J	N	H ₁	H ₂	B ₁	S	No.		Basic load rating (N)		Radial			Axial	
		Cr		Cor															
1N=0.102kgf																			
12	KHPP201A	22.2	86	25	68	9.5	3.2	44	28.6	6.5	M 8	KH201AE	9550	4800	PP3	0.18	2150	830	
15	KHPP202A	22.2	86	25	68	9.5	3.2	44	28.6	6.5	M 8	KH202AE	9550	4800	PP3	0.17	2150	830	
17	KHPP203A	22.2	86	25	68	9.5	3.2	44	28.6	6.5	M 8	KH203AE	9550	4800	PP3	0.16	2150	830	
20	KHPP204A	25.4	98	32	76	9.5	3.2	50	31	7.5	M 8	KH204AE	12800	6600	PP4	0.25	2650	1030	
25	KHPP205A	28.6	108	32	86	11.5	4	56	31	7.5	M10	KH205AE	14000	7900	PP5	0.33	3700	1470	
30	KHPP206A	33.3	117	38	95	11.5	4	66	35.7	9	M10	KH206AE	19600	11300	PP6	0.48	4400	1670	
35	KHPP207A	39.7	129	42	106	11.5	4.6	78	38.9	9.5	M10	KH207AE	25900	15400	PP7	0.72	4900	1860	

Square Flange Units
UCF type
 With set screws
 Cylindrical bore
 Shaft dia.: 12~60mm

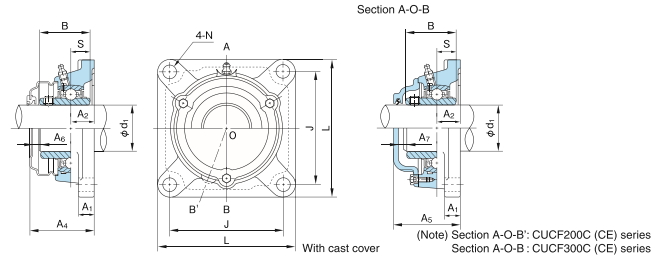
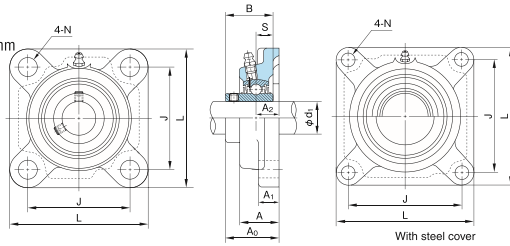

Shaft dia. d1 (mm)	Unit No.	Boundary dimensions (mm)													Bolt size	Bearings			Housing No.	Unit No. with steel cover Cover with rubber seal (End cover)	Unit No. with cast cover Cover with rubber seal (End cover)	Mass of Unit (kg)		
		L	A	J	N	A1	A2	A0	B	S	A4	A5	A6	A7		No.	Basic load rating (N) Cr	Cor				standard	with steel cover	with cast cover
12	UCF201	86	25.5	64	12	12	15	33.3	31	12.7	43	46	8	6	M10	UC201	12800	6600	F204	UCF201C(E)	CUCF201C(CE)	0.64	0.67	1.0
15	UCF202	86	25.5	64	12	12	15	33.3	31	12.7	43	46	8	6	M10	UC202	12800	6600	F204	UCF202C(E)	CUCF202C(CE)	0.62	0.65	1.0
17	UCF203	86	25.5	64	12	12	15	33.3	31	12.7	43	46	8	6	M10	UC203	12800	6600	F204	UCF203C(E)	CUCF203C(CE)	0.61	0.64	1.0
20	UCF204	86	25.5	64	12	12	15	33.3	31	12.7	43	46	8	6	M10	UC204	12800	6600	F204	UCF204C(E)	CUCF204C(CE)	0.59	0.62	1.0
25	UCF205	95	27	70	12	14	16	35.7	34	14.3	48	51	11	9	M10	UC205	14000	7900	F205	UCF205C(E)	CUCF205C(CE)	0.82	0.86	1.2
	UCF205	108	30	83	12	13	18	40.2	38.1	15.9	51	—	9	—	M10	UCX05	19600	11300	FX05	UCFX05C(E)	—	1.1	1.2	—
	UCF305	110	29	80	16	13	16	39	38	15	—	55	—	10	M14	UC305	21300	10900	F305	—	CUCF305C(CE)	1.2	—	1.6
30	UCF206	108	31	83	12	14	18	40.2	38.1	15.9	51	55	9	8	M10	UC206	19600	11300	F206	UCF206C(E)	CUCF206C(CE)	1.1	1.2	1.6
	UCFX06	117	34	92	16	14	19	44.4	42.9	17.5	54	—	8	—	M14	UCX06	25900	15400	FX06	UCFX06C(E)	—	1.3	1.3	—
	UCF306	125	32	95	16	15	18	44	43	17	—	60	—	10	M14	UC306	26800	15000	F306	—	CUCF306C(CE)	1.7	—	2.1
35	UCF207	117	34	92	14	16	19	44.4	42.9	17.5	54	59	8	8	M12	UC207	25900	15400	F207	UCF207C(E)	CUCF207C(CE)	1.5	1.6	2.1
	UCFX07	130	38	102	16	14	21	51.2	49.2	19	63	—	10	—	M14	UCX07	29300	17900	FX07	UCFX07C(E)	—	1.8	1.8	—
	UCF307	135	36	100	19	16	20	49	48	19	—	65	—	10	M16	UC307	33500	19200	F307	—	CUCF307C(CE)	2.1	—	2.6
40	UCF208	130	36	102	16	16	21	51.2	49.2	19	62	66	10	8	M14	UC208	29300	17900	F208	UCF208C(E)	CUCF208C(CE)	2.0	2.1	2.7
	UCFX08	137	40	105	19	14	22	52.2	49.2	19	63	—	10	—	M16	UCX08	33000	20500	FX08	UCFX08C(E)	—	1.8	1.8	—
	UCF308	150	40	112	19	17	23	56	52	19	—	73	—	11	M16	UC308	40500	23900	F308	—	CUCF308C(CE)	2.9	—	3.4
45	UCF209	137	38	105	16	18	22	52.2	49.2	19	63	67	10	8	M14	UC209	33000	20500	F209	UCF209C(E)	CUCF209C(CE)	2.4	2.5	3.1
	UCFX09	143	40	111	19	14	23	55.6	51.6	19	67	—	9	—	M16	UCX09	35500	23200	FX09	UCFX09C(E)	—	2.4	2.5	—
	UCF309	160	44	125	19	18	25	60	57	22	—	78	—	12	M16	UC309	51500	29500	F309	—	CUCF309C(CE)	3.6	—	4.3
50	UCF210	143	40	111	16	18	22	54.6	51.6	19	66	71	9	10	M14	UC210	35500	23200	F210	UCF210C(E)	CUCF210C(CE)	2.5	2.6	3.6
	UCFX10	162	44	130	19	20	26	59.4	55.6	22.2	70	—	9	—	M16	UCX10	43000	29400	FX10	UCFX10C(E)	—	3.6	3.7	—
	UCF310	175	48	132	23	19	28	67	61	22	—	85	—	12	M20	UC310	61500	38200	F310	—	CUCF310C(CE)	4.7	—	5.5
55	UCF211	162	43	130	19	20	25	58.4	55.6	22.2	69	75	9	10	M16	UC211	43000	29400	F211	UCF211C(E)	CUCF211C(CE)	3.4	3.6	4.6
	UCFX11	175	49	143	19	20	29	68.7	65.1	25.4	79	—	9	—	M16	UCX11	52500	36100	FX11	UCFX11C(E)	—	4.5	4.6	—
	UCF311	185	52	140	23	20	30	71	66	25	—	90	—	13	M20	UC311	71500	44800	F311	—	CUCF311C(CE)	5.7	—	6.7
60	UCF212	175	48	143	19	20	29	68.7	65.1	25.4	80	86	10	11	M16	UC212	52500	36100	F212	UCF212C(E)	CUCF212C(CE)	4.6	4.8	5.9
	UCFX12	187	59	149	19	21	34	73.7	65.1	25.4	86	—	11	—	M16	UCX12	57500	40000	FX12	UCFX12C(E)	—	5.3	5.5	—
	UCF312	195	56	150	23	22	33	78	71	26	—	98	—	14	M20	UC312	81500	52000	F312	—	CUCF312C(CE)	6.8	—	7.7

Remarks: 1. Grease nipple : 1/4-28UNF

Remarks: 2. Examples of unit numbers with cover:
 With steel cover { Cover with rubber seal :UCF210C
 End cover UCF210E
 With cast cover { Cover with rubber seal :CUCF210C
 End cover CUCF210CE

Square Flange Units
UCF type
 With set screws
 Cylindrical bore
 Shaft dia.:
 65~140mm

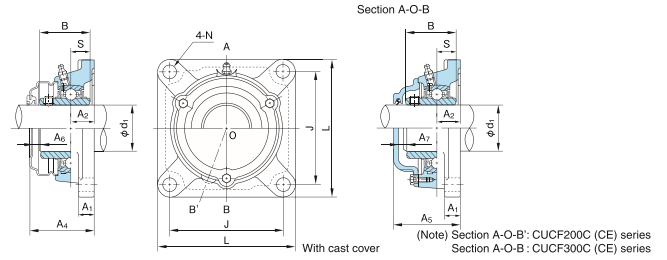
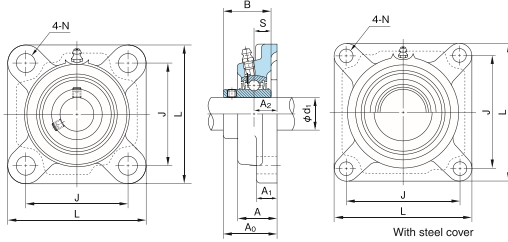

Shaft dia. d1 (mm)	Unit No.	Boundary dimensions (mm)													Bolt size	Bearings			Housing No.	Unit No. with steel cover Cover with rubber seal (End cover)	Unit No. with cast cover Cover with rubber seal (End cover)	Mass of Unit (kg)		
		L	A	J	N	A1	A2	A0	B	S	A4	A5	A6	A7		No.	Basic load rating (N) Cr	Cor				standard	With steel cover	With cast cover
65	UCF213	187	50	149	19	20	30	69.7	65.1	25.4	81	89	10	13	M16	UC213	57500	40000	F213	UCF213C(E)	CUCF213C(CE)	5.5	5.8	7.1
	UCFX13	187	59	149	19	21	34	78.4	74.6	30.2	—	—	—	—	M16	UCX13	62000	44000	FX13	—	—	5.5	—	—
	UCF313	208	58	166	23	22	33	78	75	30	—	103	—	17	M20	UC313	92500	59700	F313	—	CUCF313C(CE)	7.8	—	11.5
70	UCF214	193	54	152	19	24	31	75.4	74.6	30.2	—	98	—	16	M16	UC214	62000	44000	F214	—	CUCF214C(CE)	6.1	—	7.8
	UCFX14	197	60	152	23	24	37	81.5	77.8	33.3	—	—	—	—	M20	UCX14	66000	48200	FX14	—	—	7.7	—	—
	UCF314	226	61	178	25	25	36	81	78	33	—	106	—	17	M22	UC314	104000	68000	F314	—	CUCF314C(CE)	9.6	—	12.1
75	UCF215	200	56	159	19	24	34	78.5	77.8	33.3	—	102	—	17	M16	UC215	66000	48200	F215	—	CUCF215C(CE)	6.9	—	8.6
	UCFX15	197	68	152	23	24	40	89.3	82.6	33.3	—	—	—	—	M20	UCX15	72500	53000	FX15	—	—	7.7	—	—
	UCF315	236	66	184	25	25	39	89	82	32	—	114	—	17	M22	UC315	114000	76900	F315	—	CUCF315C(CE)	11.7	—	13.6
80	UCF216	208	58	165	23	24	34	83.3	82.6	33.3	—	107	—	15	M20	UC216	72500	53000	F216	—	CUCF216C(CE)	7.8	—	10.0
	UCFX16	214	70	171	23	24	40	91.6	85.7	34.1	—	—	—	—	M20	UCX16	83500	61800	FX16	—	—	10.2	—	—
	UCF316	250	68	196	31	27	38	90	86	34	—	115	—	17	M27	UC316	123000	86400	F316	—	CUCF316C(CE)	13.7	—	15.9
85	UCF217	220	63	175	23	26	36	87.6	85.7	34.1	—	111	—	15	M20	UC217	83500	61800	F217	—	CUCF217C(CE)	9.3	—	11.8
	UCFX17	214	70	171	23	24	40	96.3	96	39.7	—	—	—	—	M20	UCX17	95500	71400	FX17	—	—	10.2	—	—
	UCF317	260	74	204	31	27	44	100	96	40	—	126	—	18	M27	UC317	132000	96500	F317	—	CUCF317C(CE)	15.2	—	18.4
90	UCF218	235	68	187	23	26	40	96.3	96	39.7	—	122	—	17	M20	UC218	95500	71400	F218	—	CUCF218C(CE)	11.3	—	14.9
	UCFX18	214	76	171	23	24	45	106.1	104	42.9	—	—	—	—	M20	UCX18	109000	81600	FX18	—	—	10.6	—	—
	UCF318	280	76	216	35	30	44	100	96	40	—	128	—	20	M30	UC318	143000	107200	F318	—	CUCF318C(CE)	18.8	—	21.5
95	UCF319	290	94	228	35	30	59	121	103	41	—	149	—	20	M30	UC319	153000	118400	F319	—	CUCF319C(CE)	20.7	—	24.2
100	UCFX20	268	97	211	31	31	59	127.3	117.5	49.2	—	—	—	—	M27	UCX20	134000	104700	FX20	—	—	16.8	—	—
	UCF320	310	94	242	38	32	59	125	108	42	—	154	—	21	M33	UC320	173000	140400	F320	—	CUCF320C(CE)	24.8	—	29.6
105	UCF321	310	94	242	38	32	59	127	112	44	—	156	—	21	M33	UC321	183000	153100	F321	—	CUCF321C(CE)	25.6	—	32.2
110	UCF322	340	96	266	41	35	60	131	117	46	—	165	—	26	M36	UC322	205000	178800	F322	—	CUCF322C(CE)	34.7	—	38.7
120	UCF324	370	110	290	41	40	65	140	126	51	—	175	—	25	M36	UC324	207000	184800	F324	—	CUCF324C(CE)	47.2	—	52.3
130	UCF326	410	115	320	41	45	65	146	135	54	—	180	—	24	M36	UC326	229000	214300	F326	—	CUCF326C(CE)	62.7	—	67.3
140	UCF328	450	125	350	41	55	75	161	145	59	—	195	—	24	M36	UC328	255000	246000	F328	—	CUCF328C(CE)	87.0	—	89.4

Remarks: 1. Grease nipple: 1/4-28UNF for bore number 13 and under
 PF1/8 for bore number 14 and over

Remarks: 2. Examples of unit numbers with cover:
 With steel cover { Cover with rubber seal :UCF213C
 End cover :UCF213E
 With cast cover { Cover with rubber seal :CUCF213C
 End cover :CUCF213CE

Square Flange Units
UKF+H type
 With adapter assembly
 Tapered bore
 Shaft dia.:
 20~60mm

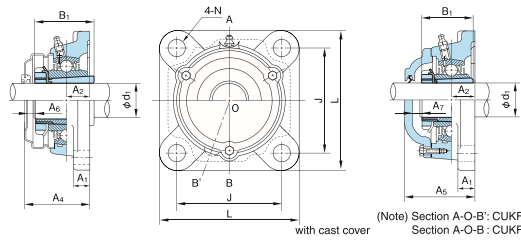
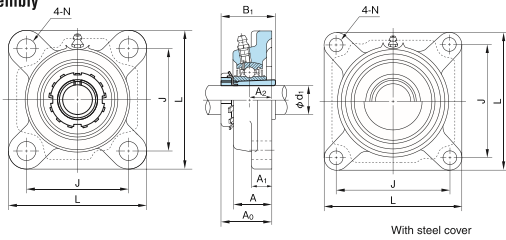

(Note) Section A-O-B: CUKF200C (CE) series+H series
 Section A-O-B: CUKF300C (CE) series+H series

Shaft dia. d ₁ (mm)	Unit No.	Boundary dimensions (mm)											Bolt size	Bearings			Housing No.	Unit No. with steel cover		Unit No. with cast cover		Mass of Unit (kg)		
		L	A	J	N	A ₁	A ₂	A ₃	B ₁	A ₄	A ₅	A ₆		A ₇	No.	Basic load rating (N) Cr		Cor	with rubber seal (End cover)	Cover with rubber seal (End cover)	standard	With steel cover	with cast cover	
20	UKF205+H2305	95	27	70	12	14	16	35.5	35	48	51	11	9	M10	UK205+H2305	14000	7900	F205	UKF205C(E)+H2305	CUKF205C(CE)+H2305	0.87	0.91	1.3	
	UKFX05+H2305	108	30	83	12	13	18	39	35	51	—	10	—	M10	UKX05+H2305	19600	11300	FX05	UKFX05C(E)+H2305	—	—	—	—	—
	UKF305+H2305	110	29	80	16	13	16	37	35	—	55	—	12	M14	UK305+H2305	21300	10900	F305	—	CUKF305C(CE)+H2305	1.2	—	1.7	
25	UKF206+H2306	108	31	83	12	14	18	39	38	51	55	10	10	M10	UK206+H2306	19600	11300	F206	UKF206C(E)+H2306	CUKF206C(CE)+H2306	1.2	1.3	1.7	
	UKFX06+H2306	117	34	92	16	14	19	40.5	38	54	—	12	—	M14	UKX06+H2306	25900	15400	FX06	UKFX06C(E)+H2306	—	—	—	—	—
	UKF306+H2306	125	32	95	16	15	18	40.5	38	—	60	—	13	M14	UK306+H2306	26800	15000	F306	—	CUKF306C(CE)+H2306	1.7	—	2.2	
30	UKF207+H2307	117	34	92	14	16	19	41.5	43	54	59	11	11	M12	UK207+H2307	25900	15400	F207	UKF207C(E)+H2307	CUKF207C(CE)+H2307	1.5	1.7	2.2	
	UKFX07+H2307	130	38	102	16	14	21	44.5	43	63	—	17	—	M14	UKX07+H2307	29300	17900	FX07	UKFX07C(E)+H2307	—	—	—	—	—
	UKF307+H2307	135	36	100	19	16	20	44.5	43	—	65	—	14	M16	UK307+H2307	33500	19200	F307	—	CUKF307C(CE)+H2307	2.1	—	2.7	
35	UKF208+H2308	130	36	102	16	16	21	45.5	46	62	66	15	14	M14	UK208+H2308	29300	17900	F208	UKF208C(E)+H2308	CUKF208C(CE)+H2308	2.1	2.2	2.8	
	UKFX08+H2308	137	40	105	19	14	22	47	46	63	—	15	—	M16	UKX08+H2308	33000	20500	FX08	UKFX08C(E)+H2308	—	—	—	—	—
	UKF308+H2308	150	40	112	19	17	23	50	46	—	73	—	17	M16	UK308+H2308	40500	23900	F308	—	CUKF308C(CE)+H2308	3.0	—	3.5	
40	UKF209+H2309	137	38	105	16	18	22	48	50	63	67	14	13	M14	UK209+H2309	33000	20500	F209	UKF209C(E)+H2309	CUKF209C(CE)+H2309	2.5	2.6	3.2	
	UKFX09+H2309	143	40	111	19	14	23	49.5	50	67	—	16	—	M16	UKX09+H2309	35500	23200	FX09	UKFX09C(E)+H2309	—	—	—	—	—
	UKF309+H2309	160	44	125	19	18	25	54.5	50	—	78	—	17	M16	UK309+H2309	51500	29500	F309	—	CUKF309C(CE)+H2309	3.6	—	4.4	
45	UKF210+H2310	143	40	111	16	18	22	49.5	55	66	71	15	15	M14	UK210+H2310	35500	23200	F210	UKF210C(E)+H2310	CUKF210C(CE)+H2310	2.7	2.8	3.8	
	UKFX10+H2310	162	44	130	19	20	26	54.5	55	70	—	14	—	M16	UKX10+H2310	43000	29400	FX10	UKFX10C(E)+H2310	—	—	—	—	—
	UKF310+H2310	175	48	132	23	19	28	60	55	—	85	—	19	M20	UK310+H2310	61500	38200	F310	—	CUKF310C(CE)+H2310	4.8	—	5.8	
50	UKF211+H2311	162	43	130	19	20	25	53.5	59	69	75	14	15	M16	UK211+H2311	43000	29400	F211	UKF211C(E)+H2311	CUKF211C(CE)+H2311	3.6	3.8	4.8	
	UKFX11+H2311	175	49	143	19	20	29	59	59	79	—	19	—	M16	UKX11+H2311	52500	36100	FX11	UKFX11C(E)+H2311	—	—	—	—	—
	UKF311+H2311	185	52	140	23	20	30	63.5	59	—	90	—	20	M20	UK311+H2311	71500	44800	F311	—	CUKF311C(CE)+H2311	5.7	—	6.8	
55	UKF212+H2312	175	48	143	19	20	29	60	62	80	86	19	20	M16	UK212+H2312	52500	36100	F212	UKF212C(E)+H2312	CUKF212C(CE)+H2312	4.6	4.9	6.0	
	UKFX12+H2312	187	59	149	19	21	34	66	62	86	—	19	—	M16	UKX12+H2312	57500	40000	FX12	UKFX12C(E)+H2312	—	—	—	—	—
	UKF312+H2312	195	56	150	23	22	33	69	62	—	98	—	23	M20	UK312+H2312	81500	52000	F312	—	CUKF312C(CE)+H2312	6.7	—	7.8	
60	UKF213+H2313	187	50	149	19	20	30	63	65	81	89	17	20	M16	UK213+H2313	57500	40000	F213	UKF213C(E)+H2313	CUKF213C(CE)+H2313	5.7	6.0	7.2	
	UKFX13+H2313	187	59	149	19	21	34	68	65	—	—	—	—	M16	UKX13+H2313	62000	44000	FX13	—	—	—	—	—	
	UKF313+H2313	208	58	166	23	22	33	71	65	—	103	—	24	M20	UK313+H2313	92500	59700	F313	—	CUKF313C(CE)+H2313	7.7	—	11.5	

Remarks: 1. Grease nipple: 1/4-28UNF

Remarks: 2. Examples of unit numbers with cover:

- With steel cover { Cover with rubber seal: UKF210C+H2310
- { End cover: UKF210E+H2310
- with cast cover { Cover with rubber seal: CUKF210C+H2310
- { End cover: CUKF210CE+H2310

Square Flange Units
UKF+H type
With adapter assembly
Tapered bore
 Shaft dia.:
 65~125mm

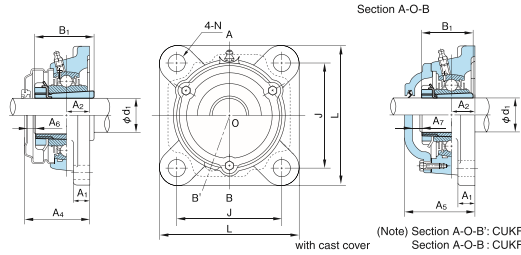
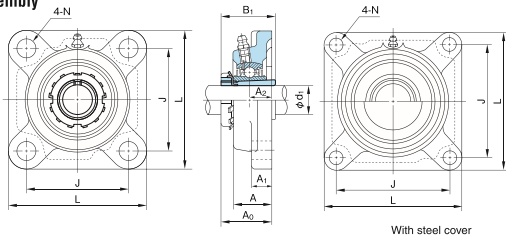

(Note) Section A-O-B: CUKF200C (CE) series+H series
 Section A-O-B: CUKF300C (CE) series+H series

Shaft dia. d ₁ (mm)	Unit No.	Boundary dimensions (mm)											Bolt size	Bearings			Housing No.	Unit No. with steel cover Cover with rubber seal (End cover)	Unit No. with cast cover Cover with rubber seal (End cover)	Mass of Unit (kg)			
		L	A	J	N	A ₁	A ₂	A ₃	B ₁	A ₄	A ₅	A ₆		A ₇	No.	Basic load rating (N) Cr				Cor	standard	With steel cover	with cast cover
65	UKF215+H2315	200	56	159	19	24	34	69.5	73	—	102	—	26	M16	UK215+H2315	66000	48200	F215	—	CUKF215C(CE)+H2315	7.3	—	9.0
	UKFX15+H2315	197	68	152	23	24	40	77	73	—	—	—	M20	UKX15+H2315	72500	53000	FX15	—	—	7.7	—	—	
	UKF315+H2315	236	66	184	25	25	39	81	73	—	114	—	M22	UK315+H2315	114000	76900	F315	—	CUKF315C(CE)+H2315	11.8	—	14.0	
70	UKF216+H2316	208	58	165	23	24	34	73	78	—	107	—	M20	UK216+H2316	72500	53000	F216	—	CUKF216C(CE)+H2316	8.2	—	10.4	
	UKFX16+H2316	214	70	171	23	24	40	80	78	—	—	—	M20	UKX16+H2316	83500	61800	FX16	—	—	10.2	—	—	
	UKF316+H2316	250	68	196	31	27	38	83.5	78	—	115	—	M27	UK316+H2316	123000	86400	F316	—	CUKF316C(CE)+H2316	13.9	—	16.3	
75	UKF217+H2317	220	63	175	23	26	36	77	82	—	111	—	M20	UK217+H2317	83500	61800	F217	—	CUKF217C(CE)+H2317	9.8	—	12.4	
	UKFX17+H2317	214	70	171	23	24	40	82.5	82	—	—	—	M20	UKX17+H2317	95500	71400	FX17	—	—	10.1	—	—	
	UKF317+H2317	260	74	204	31	27	44	92	82	—	126	—	M27	UK317+H2317	132000	96500	F317	—	CUKF317C(CE)+H2317	15.1	—	18.6	
80	UKF218+H2318	235	68	187	23	26	40	82.5	86	—	122	—	M20	UK218+H2318	95500	71400	F218	—	CUKF218C(CE)+H2318	11.7	—	15.3	
	UKFX18+H2318	214	76	171	23	24	45	89	86	—	—	—	M20	UKX18+H2318	109000	81600	FX18	—	—	10.2	—	—	
	UKF318+H2318	280	76	216	35	30	44	93.5	86	—	128	—	M30	UK318+H2318	143000	107200	F318	—	CUKF318C(CE)+H2318	19.0	—	22.5	
85	UKF319+H2319	290	94	228	35	30	59	111	90	—	149	—	M30	UK319+H2319	153000	118400	F319	—	CUKF319C(CE)+H2319	20.8	—	24.4	
	UKFX20+H2320	268	97	211	31	31	59	108	97	—	—	—	M27	UKX20+H2320	134000	104700	FX20	—	—	15.9	—	—	
90	UKF320+H2320	310	94	242	38	32	59	115	97	—	154	—	M33	UK320+H2320	173000	140400	F320	—	CUKF320C(CE)+H2320	24.8	—	30.2	
	UKFX22+H2322	340	96	266	41	35	60	121	105	—	165	—	M36	UK322+H2322	205000	178800	F322	—	CUKF322C(CE)+H2322	34.8	—	39.4	
110	UKF324+H2324	370	110	290	41	40	65	130	112	—	175	—	M36	UK324+H2324	207000	184800	F324	—	CUKF324C(CE)+H2324	46.7	—	52.5	
	UKF326+H2326	410	115	320	41	45	65	134	121	—	180	—	M36	UK326+H2326	229000	214300	F326	—	CUKF326C(CE)+H2326	63.0	—	68.8	
125	UKF328+H2328	450	125	350	41	55	75	148	131	—	195	—	M36	UK328+H2328	255000	246000	F328	—	CUKF328C(CE)+H2328	87.3	—	90.9	

Remarks: 1. Grease nipple: PF1/B

Remarks: 2. Examples of unit numbers with cover:
 With cast cover { Cover with rubber seal: CUKF215C+H2315
 End cover :CUKF215CE+H2315

Square Flange Units
BF type
 With set screws
 Cylindrical bore
 Shaft dia.: 20~35mm

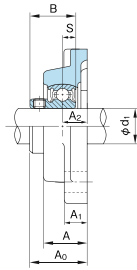
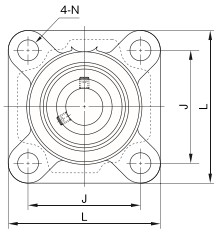

1N=0.102kgf

Shaft dia. d ₁ (mm)	Unit No.	Boundary dimensions (mm)										Bolt size	Bearings			Housing No.	Mass of Unit (kg)
		L	A	J	N	A ₁	A ₂	A ₀	B	S	No.		Basic load rating (N)				
													C _r	C _{0r}			
20	BF204	86	25.5	64	12	12	15	32.7	24.7	7	M10	B4	12800	6600	F204 G00	0.55	
25	BF205	95	27	70	12	14	16	36.2	27	7.5	M10	B5	14000	7900	F205 G00	0.79	
30	BF206	108	31	83	12	14	18	40.3	30.3	8	M10	B6	19600	11300	F206 G00	1.1	
35	BF207	117	34	92	14	16	19	43.4	32.9	8.5	M12	B7	25900	15400	F207 G00	1.5	

Square Flange Units
UGF type
With eccentric collar
Cylindrical bore
 Shaft dia.: 20~60mm

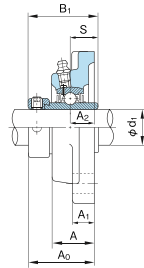
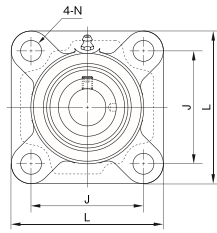

Shaft dia. d ₁ (mm)	Unit No.	Boundary dimensions (mm)										Bolt size	Bearings			Housing No.	Mass of Unit (kg)
		L	A	J	N	A ₁	A ₂	A ₀	B ₁	S	No.		Basic load rating (N)				
													Cr	Cor			
20	UGF204	86	25.5	64	12	12	15	41.6	43.7	17.1	M10	UG204+ER	12800	6600	F204	0.63	
25	UGF205	95	27	70	12	14	16	42.9	44.4	17.5	M10	UG205+ER	14000	7900	F205	0.76	
30	UGF206	108	31	83	12	14	18	48.1	48.4	18.3	M10	UG206+ER	19600	11300	F206	1.1	
35	UGF207	117	34	92	14	16	19	51.3	51.1	18.8	M12	UG207+ER	25900	15400	F207	1.5	
40	UGF208	130	36	102	16	16	21	55.9	56.3	21.4	M14	UG208+ER	29300	17900	F208	1.9	
45	UGF209	137	38	105	16	18	22	56.9	56.3	21.4	M14	UG209+ER	33000	20500	F209	2.9	
50	UGF210	143	40	111	16	18	22	60.1	62.7	24.6	M14	UG210+ER	35500	23200	F210	2.5	
55	UGF211	162	43	130	19	20	25	68.6	71.4	27.8	M16	UG211+ER	43000	29400	F211	3.6	
60	UGF212	175	48	143	19	20	29	75.8	77.8	31	M16	UG212+ER	52500	36100	F212	4.3	

1N=0.102kgf

Remark: Grease nipple: 1/4-28UNF

Square Flange Units with spigot joint
UCFS type
With set screws
Cylindrical bore
 Shaft dia.: 25~140mm

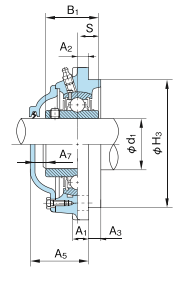
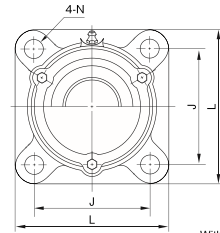
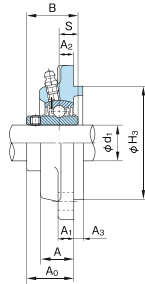
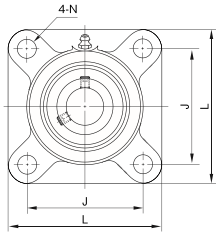

With cast covers

1N=0.102kgf

Shaft dia. d ₁ (mm)	Unit No.	Boundary dimensions (mm)													Bolt size	Bearings			Housing No.	Unit No. with cast cover		Mass of Unit (kg)	
		L	A	J	N	A ₁	A ₂	A ₃	H ₃	A ₀	B	S	A ₅	A ₇		No.	Basic load rating (N)			Cover with rubber seal (End cover)	standard	With cast cover	
																	Cr	Cor					
25	UCFS305	110	22	80	16	13	9	7	80	32	38	15	48	10	M14	UC305	21300	10900	FS305	CUCFS305C(CE)	1.4	1.7	
30	UCFS306	125	24	95	16	15	10	8	90	36	43	17	52	10	M14	UC306	26800	15000	FS306	CUCFS306C(CE)	1.9	2.3	
35	UCFS307	135	27	100	19	16	11	9	100	40	48	19	56	10	M16	UC307	33500	19200	FS307	CUCFS307C(CE)	2.4	2.8	
40	UCFS308	150	30	112	19	17	13	10	115	46	52	19	63	11	M16	UC308	40500	23900	FS308	CUCFS308C(CE)	3.3	3.8	
45	UCFS309	160	33	125	19	18	14	11	125	49	57	22	67	12	M16	UC309	51500	29500	FS309	CUCFS309C(CE)	4.0	4.8	
50	UCFS310	175	36	132	23	19	16	12	140	55	61	22	73	12	M20	UC310	61500	38200	FS310	CUCFS310C(CE)	5.3	6.1	
55	UCFS311	185	39	140	23	20	17	13	150	58	66	25	77	13	M20	UC311	71500	44800	FS311	CUCFS311C(CE)	6.2	8.2	
60	UCFS312	195	42	150	23	22	19	14	160	64	71	26	84	14	M20	UC312	81500	52000	FS312	CUCFS312C(CE)	7.4	8.5	
65	UCFS313	208	40	166	23	22	15	18	175	60	75	30	85	17	M20	UC313	92500	59700	FS313	CUCFS313C(CE)	8.6	10.6	
70	UCFS314	226	43	178	25	25	18	18	185	63	78	33	88	17	M22	UC314	104000	68000	FS314	CUCFS314C(CE)	11.2	13.0	
75	UCFS315	236	48	184	25	25	21	18	200	71	82	32	96	17	M22	UC315	114000	76900	FS315	CUCFS315C(CE)	12.7	15.5	
80	UCFS316	250	48	196	31	27	18	20	210	70	86	34	95	17	M27	UC316	123000	86400	FS316	CUCFS316C(CE)	14.3	17.6	
85	UCFS317	260	54	204	31	27	24	20	220	80	96	40	106	18	M27	UC317	132000	96500	FS317	CUCFS317C(CE)	17.2	20.7	
90	UCFS318	280	56	216	35	30	24	20	240	80	96	40	108	20	M30	UC318	143000	107200	FS318	CUCFS318C(CE)	20.4	24.9	
95	UCFS319	290	74	228	35	30	39	20	250	101	103	41	129	20	M30	UC319	153000	118400	FS319	CUCFS319C(CE)	23.9	27.4	
100	UCFS320	310	74	242	38	32	39	20	260	105	108	42	134	21	M33	UC320	173000	140400	FS320	CUCFS320C(CE)	27.1	33.9	
105	UCFS321	310	74	242	38	32	39	20	260	107	112	44	136	21	M33	UC321	183000	153100	FS321	CUCFS321C(CE)	28.5	35.7	
110	UCFS322	340	71	266	41	35	35	25	300	106	117	46	140	26	M36	UC322	205000	178800	FS322	CUCFS322C(CE)	36.8	43.6	
120	UCFS324	370	80	290	41	40	35	30	330	110	126	51	145	25	M36	UC324	207000	184800	FS324	CUCFS324C(CE)	50.6	58.6	
130	UCFS326	410	85	320	41	45	35	30	360	116	135	54	150	24	M36	UC326	229000	214300	FS326	CUCFS326C(CE)	67.8	75.7	
140	UCFS328	450	95	350	41	55	45	30	400	131	145	59	165	24	M36	UC328	255000	246000	FS328	CUCFS328C(CE)	96.3	100	

Remarks: 1. Grease nipple: 1/4-29UNF for bore number 13 and under
 FF1/8 for bore number 14 and over

Remarks: 2. Examples of unit numbers with cover:
 With cast cover { Cover with rubber seal :CUCFS310C
 End cover :CUCFS310CE

Square Flange Units with spigot joint
UKFS+H type
 With adapter assembly
 Tapered bore
 Shaft dia. : 20~125mm

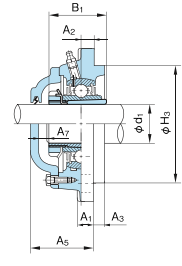
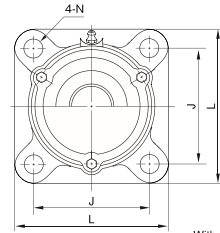
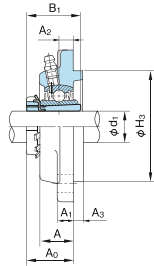
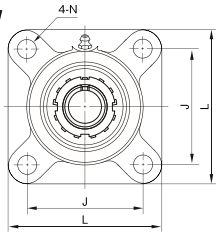

With cast covers

1N=0.102kgf

Shaft dia. d ₁ (mm)	Unit No.	Boundary dimensions (mm)												Bolt size	Bearings			Housing No.	Unit No. with cast cover		Mass of Unit (kg)	
		L	A	J	N	A ₁	A ₂	A ₃	H ₃	A ₄	B ₁	A ₅	A ₇		No.	Basic load rating (N) Cr Cor	Cover with rubber seal (End cover)		standard	With cast cover		
20	UKFS305+H2305	110	22	80	16	13	9	7	80	30	35	48	12	M14	UK305+H2305	21300	10900	FS305	CUKFS305C(CE)+H2305	1.4	1.8	
25	UKFS306+H2306	125	24	95	16	15	10	8	90	32.5	38	52	13	M14	UK306+H2306	26800	15000	FS306	CUKFS306C(CE)+H2306	1.9	2.4	
30	UKFS307+H2307	135	27	100	19	16	11	9	100	35.5	43	56	14	M16	UK307+H2307	33500	19200	FS307	CUKFS307C(CE)+H2307	2.4	2.9	
35	UKFS308+H2308	150	30	112	19	17	13	10	115	40	46	63	17	M16	UK308+H2308	40500	23900	FS308	CUKFS308C(CE)+H2308	3.3	3.9	
40	UKFS309+H2309	160	33	125	19	18	14	11	125	43.5	50	67	17	M16	UK309+H2309	51500	29500	FS309	CUKFS309C(CE)+H2309	4.0	4.9	
45	UKFS310+H2310	175	36	132	23	19	16	12	140	48	55	73	19	M20	UK310+H2310	61500	38200	FS310	CUKFS310C(CE)+H2310	5.3	6.4	
50	UKFS311+H2311	185	39	140	23	20	17	13	150	50.5	59	77	20	M20	UK311+H2311	71500	44800	FS311	CUKFS311C(CE)+H2311	6.2	8.3	
55	UKFS312+H2312	195	42	150	23	22	19	14	160	55	62	84	23	M20	UK312+H2312	81500	52000	FS312	CUKFS312C(CE)+H2312	7.4	8.6	
60	UKFS313+H2313	208	40	166	23	22	15	18	175	53	65	85	24	M20	UK313+H2313	92500	59700	FS313	CUKFS313C(CE)+H2313	8.5	10.6	
65	UKFS315+H2315	236	48	184	25	25	21	18	200	63	73	96	25	M22	UK315+H2315	114000	76900	FS315	CUKFS315C(CE)+H2315	12.8	15.9	
70	UKFS316+H2316	250	48	196	31	27	18	20	210	63.5	78	95	23	M27	UK316+H2316	123000	86400	FS316	CUKFS316C(CE)+H2316	14.5	18.0	
75	UKFS317+H2317	260	54	204	31	27	24	20	220	72	82	106	26	M27	UK317+H2317	132000	96500	FS317	CUKFS317C(CE)+H2317	17.2	20.9	
80	UKFS318+H2318	280	56	216	35	30	24	20	240	73.5	86	108	26	M30	UK318+H2318	143000	107200	FS318	CUKFS318C(CE)+H2318	20.6	25.9	
85	UKFS319+H2319	290	74	228	35	30	39	20	250	91	90	129	30	M30	UK319+H2319	153000	118400	FS319	CUKFS319C(CE)+H2319	23.9	27.6	
90	UKFS320+H2320	310	74	242	38	32	39	20	260	95	97	134	31	M33	UK320+H2320	173000	140400	FS320	CUKFS320C(CE)+H2320	27.1	34.5	
100	UKFS322+H2322	340	71	266	41	35	35	25	300	96	105	140	36	M36	UK322+H2322	205000	178800	FS322	CUKFS322C(CE)+H2322	36.7	44.3	
110	UKFS324+H2324	370	80	290	41	40	35	30	330	100	112	145	35	M36	UK324+H2324	207000	184800	FS324	CUKFS324C(CE)+H2324	50.1	58.8	
115	UKFS326+H2326	410	85	320	41	45	35	30	360	104	121	150	36	M36	UK326+H2326	229000	214300	FS326	CUKFS326C(CE)+H2326	68.1	77.2	
125	UKFS328+H2328	450	95	350	41	55	45	30	400	118	131	165	37	M36	UK238+H2328	255000	246000	FS328	CUKFS328C(CE)+H2328	96.6	102.0	

Remarks: 1. Grease nipple: 1/4-28UNF for bore number 13 and under
 PF1/8 for bore number 14 and over

Remarks: 2. Examples of unit numbers with cover:
 With cast cover { Cover with rubber seal :CUKFS310C+H2310
 End cover :CUKFS310CE+H2310

Round Flange Units with spigot joint
UCFC type
 With set screws
 Cylindrical bore
 Shaft dia.: 12~70mm

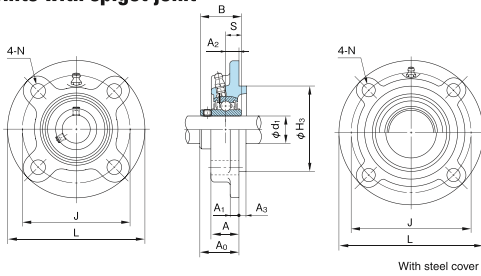

With steel cover

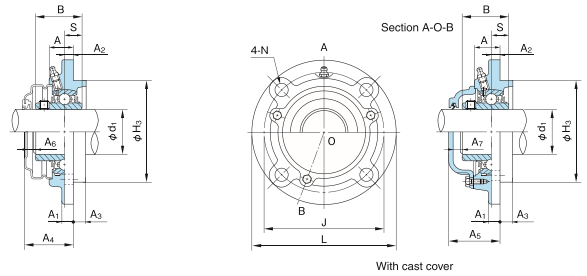

With cast cover

1N=0.102kgf

Shaft dia. d1 (mm)	Unit No.	Boundary dimensions (mm)															Bolt size	Bearings			Housing No.	Unit No. with steel cover		Unit No. with cast cover		Mass of Unit (kg)		
		L	A	J	N	A1	A2	A3	H3	A9	B	S	A4	A5	A6	A7		No.	Basic load rating (N)	Cor		Cover with rubber seal (End cover)	Cover with rubber seal (End cover)	standard	With steel cover	With cast cover		
		Cr	Cor																									
12	UCFC201	100	20.5	78	12	7	10	5	62	28.3	31	12.7	38	41	8	6	M10	UC201	12800	6600	FC204	UCFC201C(E)	CUCFC201C(CE)	0.89	0.92	1.2		
15	UCFC202	100	20.5	78	12	7	10	5	62	28.3	31	12.7	38	41	8	6	M10	UC202	12800	6600	FC204	UCFC202C(E)	CUCFC202C(CE)	0.87	0.90	1.2		
17	UCFC203	100	20.5	78	12	7	10	5	62	28.3	31	12.7	38	41	8	6	M10	UC203	12800	6600	FC204	UCFC203C(E)	CUCFC203C(CE)	0.86	0.89	1.2		
20	UCFC204	100	20.5	78	12	7	10	5	62	28.3	31	12.7	38	41	8	6	M10	UC204	12800	6600	FC204	UCFC204C(E)	CUCFC204C(CE)	0.84	0.87	1.2		
25	UCFC205	115	21	90	12	7	10	6	70	29.7	34	14.3	42	45	11	9	M10	UC205	14000	7900	FC205	UCFC205C(E)	CUCFC205C(CE)	1.1	1.1	1.5		
	UCFC205	111	24	92	9.5	9.5	10	6	76	32.2	38.1	15.9	43	—	9	—	M 8	UCX05	19600	11300	FCX05	UCFC205C(E)	—	1.1	1.1	—		
30	UCFC206	125	23	100	12	8	10	8	80	32.2	38.1	15.9	43	47	9	8	M10	UC206	19600	11300	FC206	UCFC206C(E)	CUCFC206C(CE)	1.5	1.5	2.0		
	UCFC206	127	22.5	105	12	9.5	8	9.5	85	33.4	42.9	17.5	43	—	8	—	M10	UCX06	25900	15400	FCX06	UCFC206C(E)	—	1.4	1.4	—		
35	UCFC207	135	26	110	14	9	11	8	90	36.4	42.9	17.5	46	51	8	8	M12	UC207	25900	15400	FC207	UCFC207C(E)	CUCFC207C(CE)	1.7	1.8	2.4		
	UCFC207	133	26	111	12	11	9	11	92	39.2	49.2	19	48	—	7	—	M10	UCX07	29300	17900	FCX07	UCFC207C(E)	—	1.8	1.8	—		
40	UCFC208	145	26	120	14	9	11	10	100	41.2	49.2	19	52	56	10	8	M12	UC208	29300	17900	FC208	UCFC208C(E)	CUCFC208C(CE)	2.1	2.1	2.8		
	UCFC208	133	26	111	12	11	9	11	92	39.2	49.2	19	50	—	10	—	M10	UCX08	33000	20500	FCX08	UCFC208C(E)	—	1.8	1.8	—		
45	UCFC209	160	26	132	16	14	10	12	105	40.2	49.2	19	51	55	10	8	M14	UC209	33000	20500	FC309	UCFC209C(E)	CUCFC209C(CE)	3.0	3.1	3.7		
	UCFC209	155	25	130	14	11	8	12	108	40.6	51.6	19	52	—	10	—	M12	UCX09	35500	23200	FCX09	UCFC209C(E)	—	2.5	2.6	—		
50	UCFC210	165	28	138	16	14	10	12	110	42.6	51.6	19	54	59	9	10	M14	UC210	35500	23200	FC210	UCFC210C(E)	CUCFC210C(CE)	3.1	3.3	4.2		
	UCFC210	162	25	136	14	11	7	16	118	40.4	55.6	22.2	51	—	9	—	M12	UCX10	43000	29400	FCX10	UCFC210C(E)	—	2.9	3.0	—		
55	UCFC211	185	31	150	19	15	13	12	125	46.4	55.6	22.2	57	63	9	10	M16	UC211	43000	29400	FC211	UCFC211C(E)	CUCFC211C(CE)	3.9	4.0	5.0		
	UCFC211	180	26	152	16	13	4	22	127	43.7	65.1	25.4	54	—	9	—	M14	UCX11	52500	36100	FCX11	UCFC211C(E)	—	4.0	4.2	—		
60	UCFC212	195	36	160	19	15	17	12	135	56.7	65.1	25.4	68	74	10	11	M16	UC212	52500	36100	FC212	UCFC212C(E)	CUCFC212C(CE)	4.4	4.6	6.0		
	UCFC212	194	33	165	16	14	11	20	140	50.7	65.1	25.4	63	—	11	—	M14	UCX12	57500	40000	FCX12	UCFC212C(E)	—	4.6	4.8	—		
65	UCFC213	205	36	170	19	15	16	14	145	55.7	65.1	25.4	67	75	10	13	M16	UC213	57500	40000	FC213	UCFC213C(E)	CUCFC213C(CE)	5.3	5.5	7.0		
	UCFC213	194	33	165	16	14	11	20	140	55.4	74.6	30.2	—	—	—	—	M14	UCX13	62000	44000	FCX13	—	—	4.9	—	—		
70	UCFC214	215	40	177	19	18	17	14	150	61.4	74.6	30.2	—	84	—	16	M16	UC214	62000	44000	FC214	—	CUCFC214C(CE)	6.8	—	8.2		
	UCFC214	222	36	190	19	14	14	20	164	58.5	77.8	33.3	—	—	—	—	M16	UCX14	66000	48200	FCX14	—	—	7.4	—	—		

Remarks: 1. Grease nipple: 1/4-28UNF for bore number 13 and under
 PF1/8 for bore number 14 and over

Remarks: 2. Examples of unit numbers with cover:
 With steel cover { Cover with rubber seal :UCFC210C
 End cover :UCFC210E
 With cast cover { Cover with rubber seal :CUCFC210C
 End cover :CUCFC210CE

Round Flange Units with spigot joint
UCFC type
With set screws
Cylindrical bore
 Shaft dia.: 75~100mm

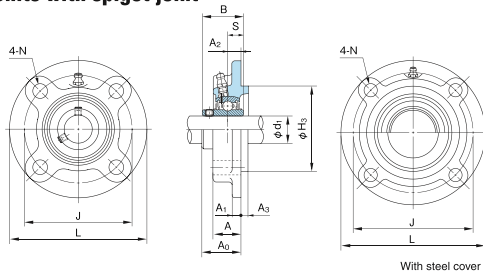

With steel cover

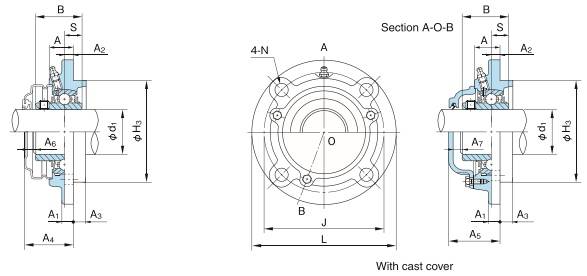

With cast cover

1N=0.102kgf

Shaft dia. d ₁ (mm)	Unit No.	Boundary dimensions (mm)															Bolt size	Bearings			Housing No.	Unit No. with steel cover		Unit No. with cast cover		Mass of Unit (kg)		
		L	A	J	N	A ₁	A ₂	A ₃	H _s	A ₆	B	S	A ₄	A ₅	A ₆	A ₇		No.	Basic load rating (N)	Cor		Cover with rubber seal (End cover)	Cover with rubber seal (End cover)	standard	With steel cover	With cast cover		
		Cr	Cor																									
75	UCFC215	220	40	184	19	18	18	16	160	62.5	77.8	33.3	—	86	—	17	M16	UC215	66000	48200	FC215	—	CUCFC215C(CE)	7.4	—	8.8		
	UCFCX15	222	35	190	19	16	12	22	164	61.3	82.6	33.3	—	—	—	—	M16	UCX15	72500	53000	FCX15	—	—	7.4	—	—		
80	UCFC216	240	42	200	23	18	18	16	170	67.3	82.6	33.3	—	91	—	15	M20	UC216	72500	53000	FC216	—	CUCFC216C(CE)	9.2	—	11.3		
	UCFCX16	260	36	219	23	19	10	25	186	61.6	85.7	34.1	—	—	—	—	M20	UCX16	83500	61800	FCX16	—	—	11.5	—	—		
85	UCFC217	250	45	208	23	20	18	18	180	69.6	85.7	34.1	—	93	—	15	M20	UC217	83500	61800	FC217	—	CUCFC217C(CE)	10.6	—	12.8		
	UCFCX17	260	36	219	23	19	10	25	186	66.3	96	39.7	—	—	—	—	M20	UCX17	95500	71400	FCX17	—	—	11.1	—	—		
90	UCFC218	265	50	220	23	20	22	18	190	78.3	96	39.7	—	104	—	17	M20	UC218	95500	71400	FC218	—	CUCFC218C(CE)	12.7	—	15.9		
	UCFCX18	260	43	219	23	19	12	28	186	73.1	104	42.9	—	—	—	—	M20	UCX18	109000	81600	FCX18	—	—	11.3	—	—		
100	UCFCX20	276	66	238	23	22	22	28	206	90.3	117.5	49.2	—	—	—	—	M20	UCX20	134000	104700	FCX20	—	—	15.9	—	—		

Remarks: 1. Grease nipple: PF1/8

Remarks: 2. Examples of unit numbers with cover:
 Cover with rubber seal: CUCFC215C
 With cast cover: End cover CUCFC215CE

Round Flange Units with spigot joint
UKFC+H type
 With adapter assembly
 Tapered bore
 Shaft dia.:
 20~90mm

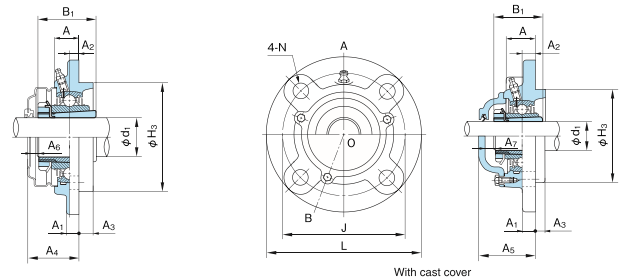
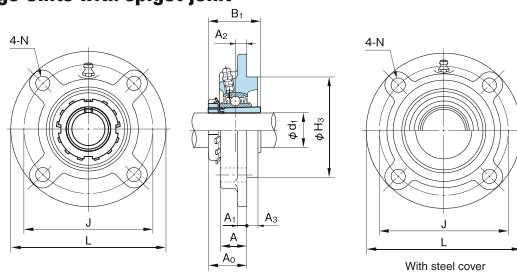

Shaft dia. d ₁ (mm)	Unit No.	Boundary dimensions (mm)													Bolt size	Bearings			Housing No.	Unit No. with steel cover		Unit No. with cast cover		Mass of Unit (kg)		
		L	A	J	N	A ₁	A ₂	A ₃	H ₃	A ₈	B ₁	A ₄	A ₅	A ₆		A ₇	No.	Basic load rating (N)		Cover with rubber seal (End cover)	Cover with rubber seal (End cover)	standard	With steel cover	With cast cover		
																		Cr							Cor	
20	UKFC205+H2305	115	21	90	12	7	10	6	70	29.5	35	42	45	11	9	M10	UK205+H2305	14000	7900	FC205	UKFC205C(E)+H2305	CUKFC205C(CE)+H2305	1.1	1.2	1.6	
	UKFCX05+H2305	111	24	92	9.5	9.5	10	6	76	31	35	43	—	10	—	M 8		UKX05+H2305	19600		11300	FCX05	—	—	1.1	1.1
25	UKFC206+H2306	125	23	100	12	8	10	8	80	31	38	43	47	10	10	M10	UK206+H2306	19600	11300	FC206	UKFC206C(E)+H2306	CUKFC206C(CE)+H2306	1.6	1.6	2.1	
	UKFCX06+H2306	127	22.5	105	12	9.5	8	9.5	85	29.5	38	43	—	12	—	M10		UKX06+H2306	25900		15400	FCX06	—	—	1.5	1.5
30	UKFC207+H2307	135	26	110	14	9	11	8	90	33.5	43	46	51	11	11	M12	UK207+H2307	25900	15400	FC207	UKFC207C(E)+H2307	CUKFC207C(CE)+H2307	1.8	1.9	2.5	
	UKFCX07+H2307	133	26	111	12	11	9	11	92	32.5	43	48	—	14	—	M10		UKX07+H2307	29300		17900	FCX07	—	—	1.8	1.8
35	UKFC208+H2308	145	26	120	14	9	11	10	100	35.5	46	52	56	15	14	M12	UK208+H2308	29300	17900	FC208	UKFC208C(E)+H2308	CUKFC208C(CE)+H2308	2.2	2.2	2.9	
	UKFCX08+H2308	133	26	111	12	11	9	11	92	34	46	50	—	15	—	M10		UKX08+H2308	33000		20500	FCX08	—	—	1.8	1.8
40	UKFC209+H2309	160	26	132	16	14	10	12	105	36	50	51	55	14	13	M14	UK209+H2309	33000	20500	FC209	UKFC209C(E)+H2309	CUKFC209C(CE)+H2309	3.1	3.2	3.8	
	UKFCX09+H2309	155	25	130	14	11	8	12	108	34.5	50	52	—	16	—	M12		UKX09+H2309	35500		23200	FCX09	—	—	2.5	2.6
45	UKFC210+H2310	165	28	138	16	14	10	12	110	37.5	55	54	59	15	15	M14	UK210+H2310	35500	23200	FC210	UKFC210C(E)+H2310	CUKFC210C(CE)+H2310	3.3	3.5	4.4	
	UKFCX10+H2310	162	25	136	14	11	7	16	118	35.5	55	51	—	14	—	M12		UKX10+H2310	43000		29400	FCX10	—	—	2.9	3.0
50	UKFC211+H2311	185	31	150	19	15	13	12	125	41.5	59	57	63	14	15	M16	UK211+H2311	43000	29400	FC211	UKFC211C(E)+H2311	CUKFC211C(CE)+H2311	4.0	4.2	5.2	
	UKFCX11+H2311	180	26	152	16	13	4	22	127	34	59	54	—	19	—	M14		UKX11+H2311	52500		36100	FCX11	—	—	3.9	4.0
55	UKFC212+H2312	195	36	160	19	15	17	12	135	48	62	68	74	19	20	M16	UK212+H2312	52500	36100	FC212	UKFC212C(E)+H2312	CUKFC212C(CE)+H2312	4.4	4.7	6.1	
	UKFCX12+H2312	194	33	165	16	14	11	20	140	43	62	63	—	19	—	M14		UKX12+H2312	57500		40000	FCX12	—	—	4.6	4.7
60	UKFC213+H2313	205	36	170	19	15	16	14	145	49	65	67	75	17	20	M16	UK213+H2313	57500	40000	FC213	UKFC213C(E)+H2313	CUKFC213C(CE)+H2313	5.4	5.7	7.2	
	UKFCX13+H2313	194	33	165	16	14	11	20	140	45	65	—	—	—	—	M14		UKX13+H2313	62000		44000	FCX13	—	—	4.7	—
65	UKFC215+H2315	220	40	184	19	18	18	16	160	53.5	73	—	—	—	—	M16	UK215+H2315	66000	48200	FC215	—	CUKFC215C(CE)+H2315	7.8	—	9.2	
	UKFCX15+H2315	222	35	190	19	16	12	22	164	49	73	—	—	—	—	M16		UKX15+H2315	72500		53000	FCX15	—	—	7.4	—
70	UKFC216+H2316	240	42	200	23	18	18	16	170	57	78	—	91	—	26	M20	UK216+H2316	72500	53000	FC216	—	CUKFC216C(CE)+H2316	9.6	—	11.7	
	UKFCX16+H2316	260	36	219	23	19	10	25	186	50	78	—	—	—	—	M20		UKX16+H2316	83500		61800	FCX16	—	—	11.6	—
75	UKFC217+H2317	250	45	208	23	20	18	18	180	59	82	—	93	—	26	M20	UK217+H2317	83500	61800	FC217	—	CUKFC217C(CE)+H2317	11.1	—	13.4	
	UKFCX17+H2317	260	36	219	23	19	10	25	186	52.5	82	—	—	—	—	M20		UKX17+H2317	95500		71400	FCX17	—	—	11.0	—
80	UKFC218+H2318	265	50	220	23	20	22	18	190	64.5	86	—	104	—	31	M20	UK218+H2318	95500	71400	FC218	—	CUKFC218C(CE)+H2318	13.1	—	16.3	
	UKFCX18+H2318	260	43	219	23	19	12	28	186	56	86	—	—	—	—	M20		UKX18+H2318	109000		81600	FCX18	—	—	11.0	—
90	UKFCX20+H2320	276	66	238	23	22	22	28	206	71	97	—	—	—	—	M20	UKX20+H2320	134000	104700	FCX20	—	—	14.9	—	—	

Remarks: 1. Grease nipple: 1/4-28UNF for bore number 13 and under
 PF1/8 for bore number 14 and over

Remarks: 2. Examples of unit numbers with cover:
 With steel cover: { Cover with rubber seal: UKFC210C+H2310
 { End cover: UKFC210E+H2310
 With cast cover: { Cover with rubber seal: CUKFC210C+H2310
 { End cover: CUKFC210CE+H2310

■ Round Flange Units with spigot joint

BFC type
With set screws
Cylindrical bore
Shaft dia.: 20~35mm

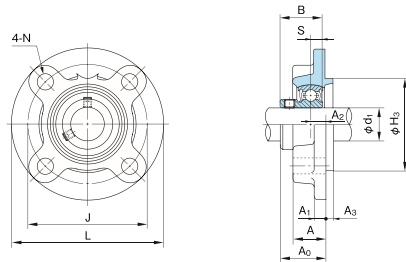

1N=0.102kgf

Shaft dia. d1 (mm)	Unit No.	Boundary dimensions (mm)											Bolt size	Bearings			Housing No.	Mass of Unit (kg)
		L	A	J	N	A1	A2	A3	H3	A0	B	S		No.	Basic load rating (N)			
															Cr	Cor		
20	BFC204	100	20.5	78	12	7	10	5	62	27.7	24.7	7	M10	B4	12800	6600	FC204 G00	0.8
25	BFC205	115	21	90	12	7	10	6	70	30.2	27	7.5	M10	B5	14000	7900	FC205 G00	1.0
30	BFC206	125	23	100	12	8	10	8	80	32.3	30.3	8	M10	B6	19600	11300	FC206 G00	1.4
35	BFC207	135	26	110	14	9	11	8	90	35.4	32.9	8.5	M12	B7	25900	15400	FC207 G00	1.7

Round Flange Units with spigot joint
UGF type
With eccentric collar
Cylindrical bore
 Shaft dia.: 20~60mm

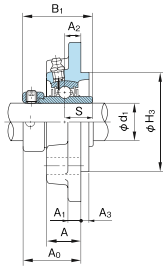
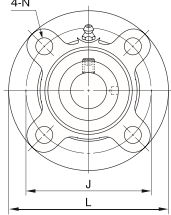

1N=0.102kgf

Shaft dia. d_1 (mm)	Unit No.	Boundary dimensions (mm)											Bolt size	Bearings			Housing No.	Mass of Unit (kg)
		L	A	J	N	A ₁	A ₂	A ₃	H ₃	A ₀	B ₁	S		No.	Basic load rating (N)			
															Cr	Cor		
20	UGFC204	100	20.5	78	12	7	10	5	62	36.6	43.7	17.1	M10	UG204+ER	12800	6600	FC204	0.89
25	UGFC205	115	21	90	12	7	10	6	70	36.9	44.4	17.5	M10	UG205+ER	14000	7900	FC205	1.0
30	UGFC206	125	23	100	12	8	10	8	80	40.1	48.4	18.3	M10	UG206+ER	19600	11300	FC206	1.2
35	UGFC207	135	26	110	14	9	11	8	90	43.3	51.1	18.8	M12	UG207+ER	25900	15400	FC207	1.7
40	UGFC208	145	26	120	14	9	11	10	100	45.9	56.3	21.4	M12	UG208+ER	29300	17900	FC208	2.0
45	UGFC209	160	26	132	16	14	10	12	105	44.9	56.3	21.4	M14	UG209+ER	39000	20500	FC209	2.5
50	UGFC210	165	28	138	16	14	10	12	110	48.1	62.7	24.6	M14	UG210+ER	35500	23200	FC210	2.8
55	UGFC211	185	31	150	19	15	13	12	125	56.6	71.4	27.8	M16	UG211+ER	43000	29400	FC211	4.1
60	UGFC212	195	36	160	19	15	17	12	135	63.8	77.8	31	M16	UG212+ER	52500	36100	FC212	4.8

Remark: Grease nipple:1/4-28UNF

Rhombic Flange Units
UCFL type
 With set screws
 Cylindrical bore
 Shaft dia.: 12~60mm

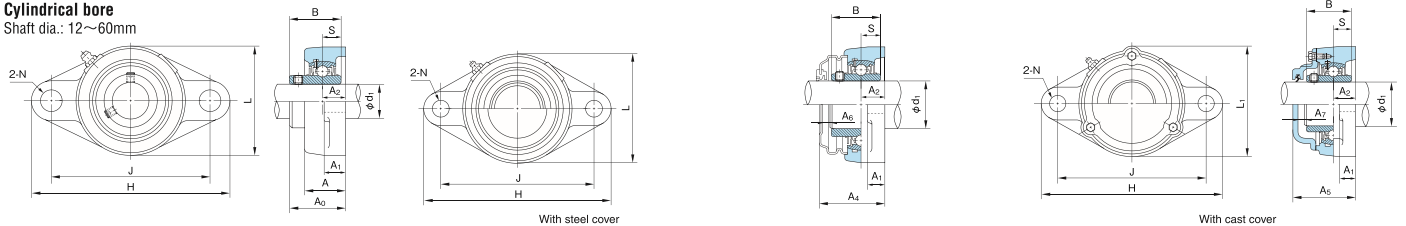

Shaft dia. d ₁ (mm)	Unit No.	Boundary dimensions (mm)															Bolt size	Bearings			Housing No.	Unit No. with steel cover		Mass of Unit (kg)		
		H	L	L ₁	A	J	N	A ₁	A ₂	A ₀	B	S	A ₄	A ₅	A ₆	A ₇		No.	Basic load rating (N)			Cover with rubber seal (End cover)	Cover with rubber seal (End cover)	standard	With steel cover	With cast cover
																			Cr	Cor						
12	UCFL201	113	60	66	25.5	90	12	12	15	33.3	31	12.7	43	46	8	6	M10	UC201	12800	6600	FL204	UCFL201C(E)	CUCFL201C(CE)	0.50	0.53	0.8
15	UCFL202	113	60	66	25.5	90	12	12	15	33.3	31	12.7	43	46	8	6	M10	UC202	12800	6600	FL204	UCFL202C(E)	CUCFL202C(CE)	0.48	0.51	0.8
17	UCFL203	113	60	66	25.5	90	12	12	15	33.3	31	12.7	43	46	8	6	M10	UC203	12800	6600	FL204	UCFL203C(E)	CUCFL203C(CE)	0.47	0.50	0.8
20	UCFL204	113	60	66	25.5	90	12	12	15	33.3	31	12.7	43	46	8	6	M10	UC204	12800	6600	FL204	UCFL204C(E)	CUCFL204C(CE)	0.45	0.48	0.8
25	UCFL205	130	68	73	27	99	16	14	16	35.7	34	14.3	47	51	10	9	M14	UC205	14000	7900	FL205	UCFL205C(E)	CUCFL205C(CE)	0.63	0.67	1.0
	UCFL206	148	80	84	31	117	12	13	18	40.2	38.1	15.9	51	—	8	—	M10	UCX05	19600	11300	FLX05	UCFLX05C(E)	—	1.0	1.0	—
	UCFL305	150	80	84	29	113	19	13	16	39	38	15	—	55	—	10	M16	UC305	21300	10900	FL305	—	CUCFL305C(CE)	1.1	—	1.4
30	UCFL206	148	80	84	31	117	16	14	18	40.2	38.1	15.9	49	55	8	8	M14	UC206	19600	11300	FL206	UCFL206C(E)	CUCFL206C(CE)	0.96	1.0	1.5
	UCFLX06	156	95	—	34	130	16	14	19	44.4	42.9	17.5	54	—	8	—	M14	UCX06	25900	15400	FLX06	UCFLX06C(E)	—	1.4	1.4	—
	UCFL306	180	90	94	32	134	23	15	18	44	43	17	—	60	—	10	M20	UC306	26800	15000	FL306	—	CUCFL306C(CE)	1.5	—	1.9
35	UCFL207	161	90	94	34	130	16	16	19	44.4	42.9	17.5	54	59	8	8	M14	UC207	25900	15400	FL207	UCFL207C(E)	CUCFL207C(CE)	1.2	1.3	1.9
	UCFLX07	171	105	—	38	144	16	14	21	51.2	49.2	19	63	—	10	—	M14	UCX07	29300	17900	FLX07	UCFLX07C(E)	—	1.9	2.0	—
	UCFL307	185	100	104	36	141	23	16	20	49	48	19	—	65	—	10	M20	UC307	33500	19200	FL307	—	CUCFL307C(CE)	1.8	—	2.3
40	UCFL208	175	100	104	36	144	16	16	21	51.2	49.2	19	61	66	9	8	M14	UC208	29300	17900	FL208	UCFL208C(E)	CUCFL208C(CE)	1.6	1.7	2.3
	UCFLX08	179	111	—	40	148	16	14	22	52.2	49.2	19	63	—	10	—	M14	UCX08	33000	20500	FLX08	UCFLX08C(E)	—	2.0	2.1	—
	UCFL308	200	112	118	40	158	23	17	23	56	52	19	—	73	—	11	M20	UC308	40500	23900	FL308	—	CUCFL308C(CE)	2.4	—	2.9
45	UCFL209	188	108	113	38	148	19	18	22	52.2	49.2	19	63	67	10	8	M16	UC209	33000	20500	FL209	UCFL209C(E)	CUCFL209C(CE)	1.9	2.0	2.7
	UCFLX09	189	116	—	40	157	16	14	23	55.6	51.6	19	67	—	9	—	M14	UCX09	35500	23200	FLX09	UCFLX09C(E)	—	2.4	2.5	—
	UCFL309	230	125	132	44	177	25	18	25	60	57	22	—	78	—	12	M22	UC309	51500	29500	FL309	—	CUCFL309C(CE)	3.4	—	4.2
50	UCFL210	197	115	120	40	157	19	18	22	54.6	51.6	19	66	71	9	10	M16	UC210	35500	23200	FL210	UCFL210C(E)	CUCFL210C(CE)	2.2	2.3	3.2
	UCFLX10	216	133	—	44	184	19	20	26	59.4	55.6	22.2	70	—	9	—	M16	UCX10	43000	29400	FLX10	UCFLX10C(E)	—	3.6	3.7	—
	UCFL310	240	140	144	48	187	25	19	28	67	61	22	—	85	—	12	M22	UC310	61500	38200	FL310	—	CUCFL310C(CE)	4.3	—	5.2
55	UCFL211	224	130	134	43	184	19	20	25	58.4	55.6	22.2	69	75	9	10	M16	UC211	43000	29400	FL211	UCFL211C(E)	CUCFL211C(CE)	3.2	3.3	4.3
	UCFL311	250	150	154	52	198	25	20	30	71	66	25	—	90	—	13	M22	UC311	71500	44800	FL311	—	CUCFL311C(CE)	5.1	—	6.0
	UCFL212	250	140	144	48	202	23	20	29	68.7	65.1	25.4	80	86	10	11	M20	UC212	52500	36100	FL212	UCFL212C(E)	CUCFL212C(CE)	4.1	4.3	5.4
60	UCFL312	270	160	164	56	212	31	22	33	78	71	26	—	98	—	14	M27	UC312	81500	52000	FL312	—	CUCFL312C(CE)	6.2	—	7.3

Remarks: 1. Grease nipple: 1/4-28UNF

Remarks: 2. Examples of unit numbers with cover:
 With steel cover { Cover with rubber seal : UCFL210C
 End cover : UCFL210E
 With cast cover { Cover with rubber seal : CUCFL210C
 End cover : CUCFL210CE

Rhombic Flange Units
UCFL type
With set screws
Cylindrical bore
 Shaft dia.: 65~140mm

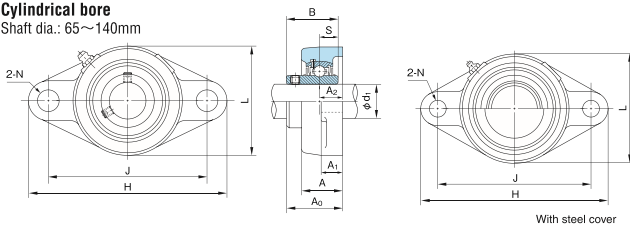

With steel cover

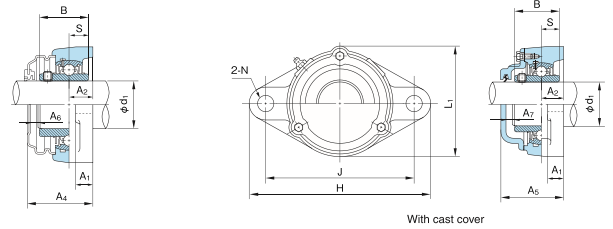

With cast cover

Shaft dia. d ₁ (mm)	Unit No.	Boundary dimensions (mm)															Bolt size	Bearings			Housing No.	Unit No. with steel cover		Mass of Unit (kg)		
		H	L	L ₁	A	J	N	A ₁	A ₂	A ₀	B	S	A ₄	A ₅	A ₆	A ₇		No.	Basic load rating (N)			Unit No. with rubber seal (End cover)	Unit No. with rubber seal (End cover)	standard	With steel cover	With cast cover
		Cr	Cor	Cover with rubber seal (End cover)	Cover with rubber seal (End cover)	standard	With steel cover	With cast cover																		
65	UCFL213	258	155	157	50	210	23	24	30	69.7	65.1	25.4	81	89	10	13	M20	UC213	57500	40000	FL213	UCFL213C(E)	CUCFL213C(CE)	5.1	5.3	6.7
	UCFL313	295	175	186	58	240	31	25	33	78	75	30	—	103	—	17	M27	UC313	92500	59700	FL313	—	—	7.4	—	9.4
70	UCFL214	265	160	163	54	216	23	24	31	75.4	74.6	30.2	—	98	—	16	M20	UC214	62000	44000	FL214	—	—	6.0	—	7.4
	UCFL314	315	185	196	61	250	35	28	36	81	78	33	—	106	—	17	M30	UC314	104000	68000	FL314	—	—	9.0	—	11.8
75	UCFL215	275	165	168	56	225	23	24	34	78.5	77.8	33.3	—	102	—	17	M20	UC215	66000	48200	FL215	—	—	6.5	—	7.9
	UCFL315	320	195	206	66	260	35	30	39	89	82	32	—	114	—	17	M30	UC315	114000	76900	FL315	—	—	10.0	—	12.2
80	UCFL216	290	180	188	58	233	25	24	34	83.3	82.6	33.3	—	107	—	15	M22	UC216	72500	53000	FL216	—	—	8.0	—	10.2
	UCFL316	355	210	218	68	285	38	32	38	90	86	34	—	115	—	17	M33	UC316	123000	86400	FL316	—	—	12.6	—	15.5
85	UCFL217	305	190	198	63	248	25	26	36	87.6	85.7	34.1	—	111	—	15	M22	UC217	83500	61800	FL217	—	—	9.5	—	11.8
	UCFL317	370	220	232	74	300	38	32	44	100	96	40	—	126	—	18	M33	UC317	132000	96500	FL317	—	—	14.5	—	18.2
90	UCFL218	320	205	211	68	265	25	26	40	96.3	96	39.7	—	122	—	17	M22	UC218	95500	71400	FL218	—	—	11.9	—	15.0
	UCFL318	385	235	245	76	315	38	36	44	100	96	40	—	128	—	20	M33	UC318	143000	107200	FL318	—	—	17.1	—	20.7
95	UCFL319	405	250	257	94	330	41	40	59	121	103	41	—	149	—	20	M36	UC319	153000	118400	FL319	—	—	21.8	—	25.8
100	UCFL320	440	270	277	94	360	44	40	59	125	108	42	—	154	—	21	M39	UC320	173000	140400	FL320	—	—	26.5	—	30.6
105	UCFL321	440	270	282	94	360	44	40	59	127	112	44	—	156	—	21	M39	UC321	183000	153100	FL321	—	—	28.2	—	31.9
110	UCFL322	470	300	305	96	390	44	42	60	131	117	46	—	165	—	26	M39	UC322	205000	178800	FL322	—	—	33.1	—	38.7
120	UCFL324	520	330	333	110	430	47	48	65	140	126	51	—	175	—	25	M42	UC324	207000	184800	FL324	—	—	45.7	—	52.4
130	UCFL326	550	360	360	115	460	47	50	65	146	135	54	—	180	—	24	M42	UC326	229000	214300	FL326	—	—	57.5	—	64.4
140	UCFL328	600	400	400	125	500	51	60	75	161	145	59	—	195	—	24	M45	UC328	255000	246000	FL328	—	—	79.7	—	86.3

Remarks: 1. Grease nipple: 1/4-28UNF for bore number 13 and under
 PF1/8 for bore number 14 and over

Remarks: 2. Examples of unit numbers with cover:
 With steel cover { Cover with rubber seal :UCFL213C
 End cover :UCFL213E
 With cast cover { Cover with rubber seal :CUCFL213C
 End cover :CUCFL213CE

■ Rhombic Flange Units
UKFL+H type
 With adapter assembly
 Tapered bore
 Shaft dia.: 20~65mm

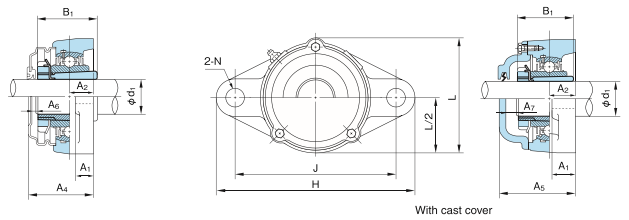
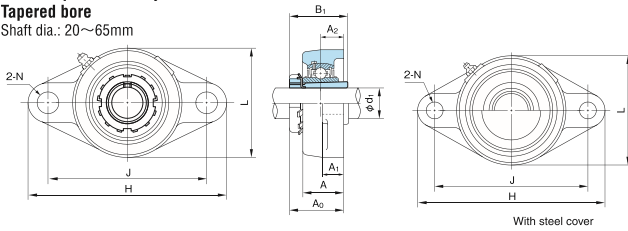

Shaft dia. d1 (mm)	Unit No.	Boundary dimensions (mm)															Bolt size	Bearings			Housing No.	Unit No. with steel cover Cover with rubber seal (End cover)	Unit No. with cast cover Cover with rubber seal (End cover)	Mass of Unit (kg)		
		H	L	L1	A	J	N	A1	A2	A3	B1	A4	A5	A6	A7	No.		Basic load rating (N)	Cr	Cor				standard	With steel cover	With cast cover
		Basic load rating (N)			Cr			Cor																		
20	UKFL205+H2305	130	68	73	27	99	16	14	16	35.5	35	47	51	10	9	M14	UK205+H2305	14000	7900	FL205	UKFL205C(E)+H2305	CUKFL205C(CE)+H2305	0.68	0.72	1.1	
	UKFLX05+H2305	141	83	-	30	117	12	13	18	39	35	51	-	9	-	M10	UKX05+H2305	19600	11300	FLX05	UKFLX05C(E)+H2305	-	1.0	1.0	-	
	UKFL305+H2305	150	80	84	29	113	19	13	16	37	35	-	55	-	12	M16	UK305+H2305	21300	10900	FL305	-	CUKFL305C(CE)+H2305	1.1	-	1.5	
25	UKFL206+H2306	148	80	84	31	117	16	14	18	39	38	49	55	9	10	M14	UK206+H2306	19600	11300	FL206	UKFL206C(E)+H2306	CUKFL206C(CE)+H2306	1.0	1.1	1.6	
	UKFLX06+H2306	156	95	-	34	130	16	14	19	40.5	38	54	-	12	-	M14	UKX06+H2306	25900	15400	FLX06	UKFLX06C(E)+H2306	-	1.5	1.5	-	
	UKFL306+H2306	180	90	94	32	134	23	15	18	40.5	38	-	60	-	13	M20	UK306+H2306	26800	15000	FL306	-	CUKFL306C(CE)+H2306	1.5	-	2.0	
30	UKFL207+H2307	161	90	94	34	130	16	16	19	41.5	43	54	59	11	11	M14	UK207+H2307	25900	15400	FL207	UKFL207C(E)+H2307	CUKFL207C(CE)+H2307	1.3	1.4	2.0	
	UKFLX07+H2307	171	105	-	38	144	16	14	21	44.5	43	63	-	17	-	M14	UKX07+H2307	29300	17900	FLX07	UKFLX07C(E)+H2307	-	1.9	2.0	-	
	UKFL307+H2307	185	100	104	36	141	23	16	20	44.5	43	-	65	-	14	M20	UK307+H2307	33500	19200	FL307	-	CUKFL307C(CE)+H2307	1.9	-	2.4	
35	UKFL208+H2308	175	100	104	36	144	16	16	21	45.5	46	61	66	14	14	M14	UK208+H2308	29300	17900	FL208	UKFL208C(E)+H2308	CUKFL208C(CE)+H2308	1.7	1.8	2.4	
	UKFLX08+H2308	179	111	-	40	148	16	14	22	47	46	63	-	15	-	M14	UKX08+H2308	33000	20500	FLX08	UKFLX08C(E)+H2308	-	2.1	2.1	-	
	UKFL308+H2308	200	112	118	40	158	23	17	23	50	46	-	73	-	17	M20	UK308+H2308	40500	23900	FL308	-	CUKFL308C(CE)+H2308	2.5	-	3.0	
40	UKFL209+H2309	188	108	113	38	148	19	18	22	48	50	63	67	14	13	M16	UK209+H2309	33000	20500	FL209	UKFL209C(E)+H2309	CUKFL209C(CE)+H2309	2.0	2.1	2.8	
	UKFLX09+H2309	189	116	-	40	157	16	14	23	49.5	50	67	-	16	-	M14	UKX09+H2309	35500	23200	FLX09	UKFLX09C(E)+H2309	-	2.4	2.5	-	
	UKFL309+H2309	230	125	132	44	177	25	18	25	54.5	50	-	78	-	17	M22	UK309+H2309	51500	29500	FL309	-	CUKFL309C(CE)+H2309	3.4	-	4.3	
45	UKFL210+H2310	197	115	120	40	157	19	18	22	49.5	55	66	71	15	15	M16	UK210+H2310	35500	23200	FL210	UKFL210C(E)+H2310	CUKFL210C(CE)+H2310	2.3	2.5	3.4	
	UKFLX10+H2310	216	133	-	44	184	19	20	26	54.5	55	70	-	14	-	M16	UKX10+H2310	43000	29400	FLX10	UKFLX10C(E)+H2310	-	3.6	3.7	-	
	UKFL310+H2310	240	140	144	48	187	25	19	28	60	55	-	85	-	19	M22	UK310+H2310	61500	38200	FL310	-	CUKFL310C(CE)+H2310	4.4	-	5.5	
50	UKFL211+H2311	224	130	134	43	184	19	20	25	53.5	59	69	75	14	15	M16	UK211+H2311	43000	29400	FL211	UKFL211C(E)+H2311	CUKFL211C(CE)+H2311	3.3	3.5	4.5	
	UKFLX11+H2311	250	150	154	52	198	25	20	30	63.5	59	-	90	-	20	M22	UK311+H2311	71500	44800	FL311	-	CUKFL311C(CE)+H2311	5.1	-	6.1	
	UKFL311+H2311	250	140	144	48	202	23	20	29	60	62	80	86	19	20	M20	UK311+H2311	71500	44800	FL311	-	CUKFL311C(CE)+H2311	5.1	-	6.1	
55	UKFL212+H2312	250	140	144	48	202	23	20	29	60	62	80	86	19	20	M20	UK212+H2312	52500	36100	FL212	UKFL212C(E)+H2312	CUKFL212C(CE)+H2312	4.1	4.4	5.5	
	UKFLX12+H2312	270	160	164	56	212	31	22	33	69	62	-	98	-	23	M27	UK312+H2312	81500	52000	FL312	-	CUKFL312C(CE)+H2312	6.1	-	7.4	
	UKFL312+H2312	258	155	157	50	210	23	24	30	63	65	81	89	17	20	M20	UK312+H2312	57500	40000	FL213	UKFL213C(E)+H2313	CUKFL213C(CE)+H2313	5.2	5.5	6.9	
60	UKFL213+H2313	258	155	157	50	210	23	24	30	63	65	81	89	17	20	M20	UK213+H2313	57500	40000	FL213	UKFL213C(E)+H2313	CUKFL213C(CE)+H2313	5.2	5.5	6.9	
	UKFLX13+H2313	295	175	186	58	240	31	25	33	71	65	-	103	-	24	M27	UK313+H2313	92500	59700	FL313	-	CUKFL313C(CE)+H2313	7.4	-	9.4	
	UKFL313+H2313	295	175	186	58	240	31	25	33	71	65	-	103	-	24	M27	UK313+H2313	92500	59700	FL313	-	CUKFL313C(CE)+H2313	7.4	-	9.4	
65	UKFL215+H2315	275	165	168	56	225	23	24	34	69.5	73	-	102	-	26	M20	UK215+H2315	66000	48200	FL215	-	CUKFL215C(CE)+H2315	6.8	-	8.3	
	UKFL315+H2315	320	195	206	66	260	35	30	39	81	73	-	114	-	25	M30	UK315+H2315	114000	76900	FL315	-	CUKFL315C(CE)+H2315	10.2	-	12.6	

Remarks: 1. Grease nipple: 1/4-28UNF for bore number 13 and under
 PF1/8 for bore number 14 and over

Remarks: 2. Examples of unit numbers with cover:

- With steel cover { Cover with rubber seal : UKFL210C+H2310
- { End cover : UKFL210E+H2310
- With cast cover { Cover with rubber seal : CUKFL210C+H2310
- { End cover : CUKFL210CE+H2310

Rhombic Flange Units
UKFL+H type
 With adapter assembly
 Tapered bore
 Shaft dia.: 70~125mm

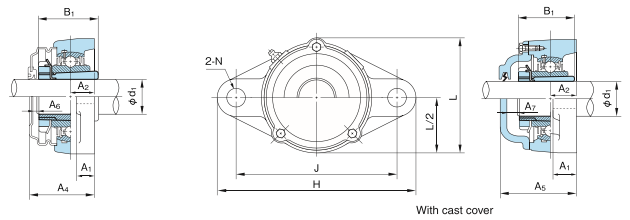
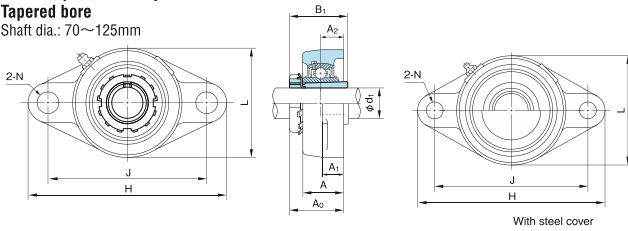

Shaft dia. d_1 (mm)	Unit No.	Boundary dimensions (mm)															Bolt size	Bearings			Housing No.	Unit No. with steel cover Cover with rubber seal (End cover)	Unit No. with cast cover Cover with rubber seal (End cover)	Mass of Unit (kg)		
		H	L	L ₁	A	J	N	A ₁	A ₂	A ₆	B ₁	A ₄	A ₅	A ₆	A ₇	No.		Basic load rating (N)		standard				With steel cover	With cast cover	
		Cr	Cor	Cor	Cor	Cor																				
70	UKFL216+H2316	290	180	188	58	233	25	24	34	73	78	—	107	—	26	M22	UK216+H2316	72500	53000	FL216	—	CUKFL216C(CE)+H2316	8.4	—	10.6	
	UKFL316+H2316	355	210	218	68	285	38	32	38	83.5	78	—	115	—	23	M33	UK316+H2316	123000	86400	FL316	—	CUKFL316C(CE)+H2316	12.8	—	15.9	
75	UKFL217+H2317	305	190	198	63	248	25	26	36	77	82	—	111	—	26	M22	UK217+H2317	83500	61800	FL217	—	CUKFL217C(CE)+H2317	10.0	—	12.4	
	UKFL317+H2317	370	220	232	74	300	38	32	44	92	82	—	126	—	26	M33	UK317+H2317	132000	96500	FL317	—	CUKFL317C(CE)+H2317	14.5	—	18.4	
80	UKFL218+H2318	320	205	211	68	265	25	26	40	82.5	86	—	122	—	31	M22	UK218+H2318	95500	71400	FL218	—	CUKFL218C(CE)+H2318	12.3	—	15.4	
	UKFL318+H2318	385	235	245	76	315	38	36	44	93.5	86	—	128	—	26	M33	UK318+H2318	149000	107200	FL318	—	CUKFL318C(CE)+H2318	17.2	—	21.7	
85	UKFL319+H2319	405	250	257	94	330	41	40	59	111	90	—	149	—	30	M36	UK319+H2319	153000	118400	FL319	—	CUKFL319C(CE)+H2319	21.8	—	26.0	
90	UKFL320+H2320	440	270	277	94	360	44	40	59	115	97	—	154	—	31	M39	UK320+H2320	173000	140400	FL320	—	CUKFL320C(CE)+H2320	26.5	—	31.2	
100	UKFL322+H2322	470	300	305	96	390	44	42	60	121	105	—	165	—	36	M39	UK322+H2322	205000	178800	FL322	—	CUKFL322C(CE)+H2322	33.2	—	39.4	
110	UKFL324+H2324	520	330	333	110	430	47	48	65	130	112	—	175	—	35	M42	UK324+H2324	207000	184800	FL324	—	CUKFL324C(CE)+H2324	45.2	—	52.6	
115	UKFL326+H2326	550	360	360	115	460	47	50	65	134	121	—	180	—	36	M42	UK326+H2326	229000	214300	FL326	—	CUKFL326C(CE)+H2326	57.8	—	65.9	
125	UKFL328+H2328	600	400	400	125	500	51	60	75	148	131	—	195	—	37	M45	UK328+H2328	255000	246000	FL328	—	CUKFL328C(CE)+H2328	80.0	—	87.8	

Remarks: 1. Grease nipple: PF1/8

Remarks: 2. Examples of unit numbers with cover:
 With cast cover { Cover with rubber seal :CUKFL320C+H2320
 End cover :CUKFL320CE+H2320

Rhombic Flange Units

BFL type

With set screws

Cylindrical bore

Shaft dia.: 20~35mm

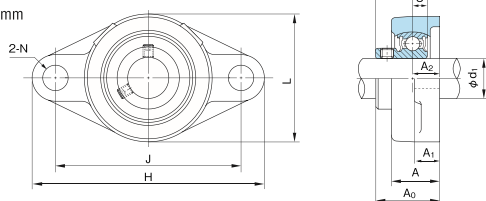

1N=0.102kgf

Shaft dia. d ₁ (mm)	Unit No.	Boundary dimensions (mm)											Bolt size	Bearings			Housing No.	Mass of Unit (kg)
		H	L	A	J	N	A ₁	A ₂	A ₀	B	S	No.		Basic lead rating (N)				
														Cr	Cor			
20	BFL204	113	60	25.5	90	12	12	15	32.7	24.7	7	M10	B4	12800	6600	FL204 G00	0.41	
25	BFL205	130	68	27	99	16	14	16	36.2	27	7.5	M14	B5	14000	7900	FL205 G00	0.60	
30	BFL206	148	80	31	117	16	14	18	40.3	30.3	8	M14	B6	19600	11300	FL206 G00	0.88	
35	BFL207	161	90	34	130	16	16	19	43.4	32.9	8.5	M14	B7	25900	15400	FL207 G00	1.2	

Rhombic Flange Units
UGFL type
 With eccentric collar
 Cylindrical bore
 Shaft dia.: 20~60mm

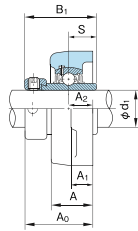
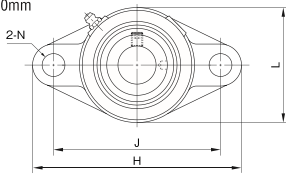

1N=0.102kgf

Shaft dia. d ₁ (mm)	Unit No.	Boundary dimensions (mm)										Bolt size	Bearings			Housing No.	Mass of Unit (kg)
		H	L	A	J	N	A ₁	A ₂	A ₀	B ₁	S		No.	Basic load rating (N)			
														C _r	C _{or}		
20	UGFL204	113	60	25.5	90	12	12	15	41.6	43.7	17.1	M10	UG204+ER	12800	6600	FL204	0.47
25	UGFL205	130	68	27	99	16	14	16	42.9	44.4	17.5	M14	UG205+ER	14000	7900	FL205	0.63
30	UGFL206	148	80	31	117	16	14	18	48.1	48.4	18.3	M14	UG206+ER	19600	11300	FL206	0.96
35	UGFL207	161	90	34	130	16	16	19	51.3	51.1	18.8	M14	UG207+ER	25900	15400	FL207	1.3
40	UGFL208	175	100	36	144	16	16	21	55.9	56.3	21.4	M14	UG208+ER	29300	17900	FL208	1.7
45	UGFL209	188	108	38	148	19	18	22	56.9	56.3	21.4	M16	UG209+ER	39000	20500	FL209	2.0
50	UGFL210	197	115	40	157	19	18	22	60.1	62.7	24.6	M16	UG210+ER	35500	23200	FL210	2.3
55	UGFL211	224	130	43	184	19	20	25	68.6	71.4	27.8	M16	UG211+ER	43000	29400	FL211	3.4
60	UGFL212	250	140	48	202	23	20	29	75.8	77.8	31	M20	UG212+ER	52500	36100	FL212	4.4

Remark: Grease nipple: 1/4-28UNF

Rhombic Flange Units

BLFL type
With set screws
Cylindrical bore
Shaft dia.: 12~35mm

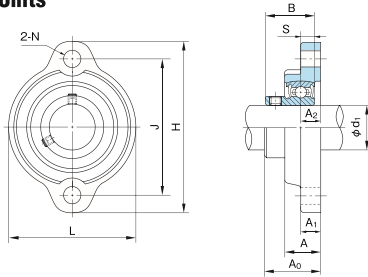

KHLFL type
With eccentric collar
Cylindrical bore
Shaft dia.: 12~35mm

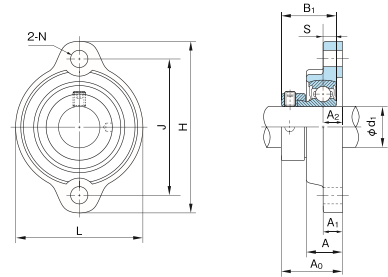

BLFL type

1N=0.102kgf

Shaft dia. d ₁ (mm)	Unit No.	Boundary dimensions (mm)											Bolt size	Bearings				Housing No.	Mass of Unit (kg)
		H	L	A	J	N	A ₁	A ₂	A ₀	B	S	No.		Basic load rating (N)					
		Cr	Cor																
12	BLFL1J	81	56	18	63.5	7	9.5	9.5	25.5	22	6	M 6	B1	9550	4800	LFL3J	0.28		
15	BLFL2J	81	56	18	63.5	7	9.5	9.5	25.5	22	6	M 6	B2	9550	4800	LFL3J	0.27		
17	BLFL3J	81	56	18	63.5	7	9.5	9.5	25.5	22	6	M 6	B3	9550	4800	LFL3J	0.25		
20	BLFL4J	90	63	20	71.5	10	11	11	28.7	24.7	7	M 8	B4	12800	6600	LFL4J	0.30		
25	BLFL5J	95	69	20	76	10	11	11	31.2	27	7.5	M 8	B5	14000	7900	LFL5J	0.40		
30	BLFL6J	113	79	22.5	90.5	12	12	12	34.3	30.3	8	M10	B6	19600	11300	LFL6J	0.58		
35	BLFL7J	122	89	24	100	12	13	13	37.4	32.9	8.5	M10	B7	25900	15400	LFL7J	0.81		

Remark: Spherical bearing seating diameter of housing is applied tolerance class J7.

KHLFL type

1N=0.102kgf

Shaft dia. d ₁ (mm)	Unit No.	Boundary dimensions (mm)											Bolt size	Bearings				Housing No.	Mass of Unit (kg)
		H	L	A	J	N	A ₁	A ₂	A ₀	B ₁	S	No.		Basic load rating (N)					
		Cr	Cor																
12	KHLFL201AJ	81	56	18	63.5	7	9.5	9.5	31.6	28.6	6.5	M 6	KH201AE	9550	4800	LFL3J	0.30		
15	KHLFL202AJ	81	56	18	63.5	7	9.5	9.5	31.6	28.6	6.5	M 6	KH202AE	9550	4800	LFL3J	0.29		
17	KHLFL203AJ	81	56	18	63.5	7	9.5	9.5	31.6	28.6	6.5	M 6	KH203AE	9550	4800	LFL3J	0.28		
20	KHLFL204AJ	90	63	20	71.5	10	11	11	34.5	31	7.5	M 8	KH204AE	12800	6600	LFL4J	0.34		
25	KHLFL205AJ	95	69	20	76	10	11	11	34.5	31	7.5	M 8	KH205AE	14000	7900	LFL5J	0.44		
30	KHLFL206AJ	113	79	22.5	90.5	12	12	12	38.7	35.7	9	M10	KH206AE	19600	11300	LFL6J	0.64		
35	KHLFL207AJ	122	89	24	100	12	13	13	42.4	38.9	9.5	M10	KH207AE	25900	15400	LFL7J	0.92		

Remark: Spherical bearing seating diameter of housing is applied tolerance class J7.

Rhombic Flange Units
Cast Stainless Steel
MUCFL type
With set screws
Cylindrical bore
 Shaft dia.: 20~50mm

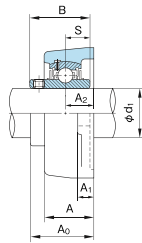
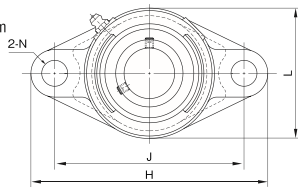

1N=0.102kgf

Shaft dia. d ₁ (mm)	Unit No.	Boundary dimensions (mm)											Bolt size	Bearings			Housing No.	Mass of Unit (kg)
		H	L	A	J	N	A ₁	A ₂	A ₀	B	S	No.		Basic load rating (N)				
														C _r	C _{0r}			
20	MUCFL204	113	60	25.5	90	12	10	15	33.3	31	12.7	M10	MUC204	10900	5300	MFL204	0.35	
25	MUCFL205	130	68	27	99	16	10	16	35.7	34	14.3	M14	MUC205	11900	6300	MFL205	0.50	
30	MUCFL206	148	80	31	117	16	10	18	40.2	38.1	15.9	M14	MUC206	16700	9050	MFL206	0.80	
35	MUCFL207	161	90	34	130	16	11	19	44.4	42.9	17.5	M14	MUC207	22000	12300	MFL207	1.05	
40	MUCFL208	175	100	36	144	16	11	21	51.2	49.2	19	M14	MUC208	24900	14300	MFL208	1.35	
45	MUCFL209	188	108	38	148	19	13	22	52.2	49.2	19	M16	MUC204	28100	16400	MFL209	1.65	
50	MUCFL210	197	115	40	157	19	13	22	54.6	51.6	19	M16	MUC210	30200	18600	MFL210	1.90	

Remark: Grease nipple: 1/4-28UNF

Silver series
Rhombic Flange Units
 UFL type
 With eccentric collar
 Cylindrical bore
 Shaft dia.: 8~30mm

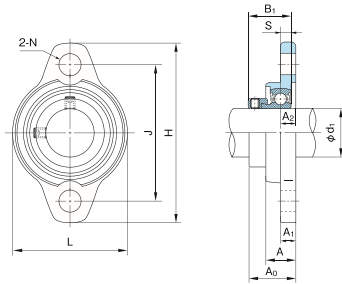

UFL type

Shaft dia. d ₁ (mm)	Unit No.	Boundary dimensions (mm)												Bolt size
		H	L	A	J	N	A ₁	A ₂	A ₀	B ₁	S	A ₄	A ₅	
10	UFL000	60	36	11.5	45	7	5.5	5.5	19	17.5	4	22	2	M 6
12	UFL001	63	38	11.5	48	7	5.5	5.5	19	17.5	4	22	2	M 6
15	UFL002	67	42	13	53	7	6.5	6.5	20.5	18.5	4.5	24	2	M 6
17	UFL003	71	46	14	56	7	7	7	22.5	20.5	5	26	2	M 6
20	UFL004	90	55	16	71	10	8	8	26.5	24.5	6	31	3	M 8
25	UFL005	95	60	16	75	10	8	8	27.5	25.5	6	32	3	M 8
30	UFL006	112	70	18	85	13	9	9	29	26.5	6.5	34	4	M10

Note: (*) Set screw type U08X is also available. Inner ring width B of U08X is 12mm. Dimension A₀ with U08X is 13mm.

MUFL type (Stainless Silver Series)
 With eccentric collar
 Cylindrical bore
 Shaft dia.: 10~30mm

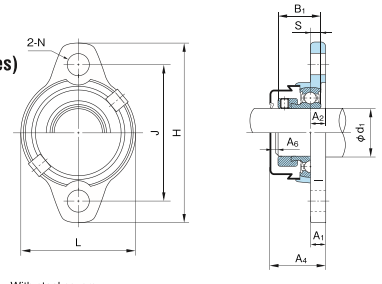

With steel covers

Shaft dia. d ₁ (mm)	Unit No.	Boundary dimensions (mm)												Bolt size	Bearings			Housing No.	Unit No. with covers			Cover No. (Reference)		Mass of Unit (kg)	
															No.	Basic load rating (N)			Cover with rubber seal (End cover)	Cover with rubber seal	Side end cover	standard	with cover		
		Cr	Cor	Cr	Cor																				
10	U000+ER	60	36	11.5	45	7	5.5	5.5	19	17.5	4	22	2	M 6	U000+ER	4600	2000	FL000	UFL000C(E)	000CP10	000CPE	60	65		
12	U001+ER	63	38	11.5	48	7	5.5	5.5	19	17.5	4	22	2	M 6	U001+ER	5100	2400	FL001	UFL001C(E)	001CP12	001CPE	76	80		
15	U002+ER	67	42	13	53	7	6.5	6.5	20.5	18.5	4.5	24	2	M 6	U002+ER	5600	2800	FL002	UFL002C(E)	002CP15	002CPE	100	105		
17	U003+ER	71	46	14	56	7	7	7	22.5	20.5	5	26	2	M 6	U003+ER	6000	3300	FL003	UFL003C(E)	003CP17	003CPE	129	135		
20	U004+ER	90	55	16	71	10	8	8	26.5	24.5	6	31	3	M 8	U004+ER	9350	5100	FL04-5	UFL004C(E)	04-5CP20	04-5CPE	205	215		
25	U005+ER	95	60	16	75	10	8	8	27.5	25.5	6	32	3	M 8	U005+ER	10100	5800	FL05-6	UFL005C(E)	05-6CP25	05-6CPE	244	255		
30	U006+ER	112	70	18	85	13	9	9	29	26.5	6.5	34	4	M10	U006+ER	13200	8300	FL06-7	UFL006C(E)	06-7CP30	06-7CPE	354	370		

Remark: Examples of unit numbers with cover: Both covers with rubber seal : UFL005C
 One side end cover : UFL005E

MUFL type (Stainless Silver Series)

Shaft dia. d ₁ (mm)	Unit No.	Boundary dimensions (mm)												Bolt size
		H	L	A	J	N	A ₁	A ₂	A ₀	B ₁	S	A ₄	A ₅	
10	MUFL000	60	36	11.5	45	7	5.5	5.5	19	17.5	4	22	2	M 6
12	MUFL001	63	38	11.5	48	7	5.5	5.5	19	17.5	4	22	2	M 6
15	MUFL002	67	42	13	53	7	6.5	6.5	20.5	18.5	4.5	24	2	M 6
17	MUFL003	71	46	14	56	7	7	7	22.5	20.5	5	26	2	M 6
20	MUFL004	90	55	16	71	10	8	8	26.5	24.5	6	31	3	M 8
25	MUFL005	95	60	16	75	10	8	8	27.5	25.5	6	32	3	M 8
30	MUFL006	112	70	18	85	13	9	9	29	26.5	6.5	34	4	M10

Shaft dia. d ₁ (mm)	Unit No.	Boundary dimensions (mm)												Bolt size	Bearings			Housing No.	Unit No. with covers			Cover No. (Reference)		Mass of Unit (kg)	
															No.	Basic load rating (N)			Cover with rubber seal (End cover)	Cover with rubber seal	Side end cover	standard	with cover		
		Cr	Cor	Cr	Cor																				
10	MU000+ER	60	36	11.5	45	7	5.5	5.5	19	17.5	4	22	2	M 6	MU000+ER	3900	1550	FL000Z3	MUFL000C(E)	000CP10	000CPE	60	65		
12	MU001+ER	63	38	11.5	48	7	5.5	5.5	19	17.5	4	22	2	M 6	MU001+ER	4300	1900	FL001Z3	MUFL001C(E)	001CP12	001CPE	76	80		
15	MU002+ER	67	42	13	53	7	6.5	6.5	20.5	18.5	4.5	24	2	M 6	MU002+ER	4750	2250	FL002Z3	MUFL002C(E)	002CP15	002CPE	100	105		
17	MU003+ER	71	46	14	56	7	7	7	22.5	20.5	5	26	2	M 6	MU003+ER	5100	2650	FL003Z3	MUFL003C(E)	003CP17	003CPE	129	135		
20	MU004+ER	90	55	16	71	10	8	8	26.5	24.5	6	31	3	M 8	MU004+ER	7900	4000	FL04-5Z3	MUFL004C(E)	04-5CP20	04-5CPE	205	215		
25	MU005+ER	95	60	16	75	10	8	8	27.5	25.5	6	32	3	M 8	MU005+ER	8600	4650	FL05-6Z3	MUFL005C(E)	05-6CP25	05-6CPE	244	255		
30	MU006+ER	112	70	18	85	13	9	9	29	26.5	6.5	34	4	M10	MU006+ER	11300	6600	FL06-7Z3	MUFL006C(E)	06-7CP30	06-7CPE	354	370		

Remark: Examples of unit numbers with cover: Cover with rubber seal : MUFL005C
 One side end cover : MUFL005E

Pressed Steel Round Flange Units

BPF type
With set screws
Cylindrical bore
Shaft dia.: 12~35mm

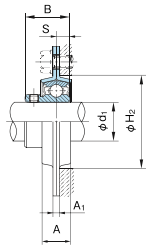
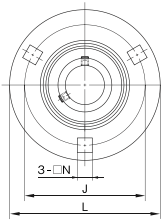

KHPF type
With eccentric collar
Cylindrical bore
Shaft dia.: 12~35mm

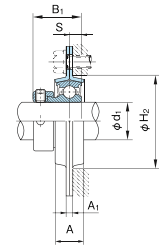
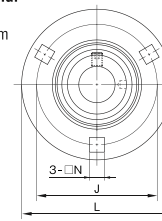

BPF type

1N=0.102kgf

Shaft dia. d ₁ (mm)	Unit No.	Boundary dimensions (mm)									Bolt size	Bearings			Housing No.	Mass of Unit (kg)	Limiting load (N)	
		L	A	J	N	A ₁	H ₂ (Min)	B	S	No.		Basic load rating (N)		Radial			Axial	
												Cr	Cor					
12	BPF1	81	14	63.5	7	4	49	22	6	M 6	B1	9550	4800	PF3	0.21	2650	1320	
15	BPF2	81	14	63.5	7	4	49	22	6	M 6	B2	9550	4800	PF3	0.20	2650	1320	
17	BPF3	81	14	63.5	7	4	49	22	6	M 6	B3	9550	4800	PF3	0.18	2650	1320	
20	BPF4	90	16	71.5	9	4	56	24.7	7	M 8	B4	12800	6600	PF4	0.25	3100	1520	
25	BPF5	95	18	76	9	4	60	27	7.5	M 8	B5	14000	7900	PF5	0.35	3550	1750	
30	BPF6	113	18	90.5	11	5.2	71	30.3	8	M10	B6	19600	11300	PF6	0.54	4900	2450	
35	BPF7	122	20	100	11	5.2	81	32.9	8.5	M10	B7	25900	15400	PF7	0.71	6200	3100	

KHPF type

1N=0.102kgf

Shaft dia. d ₁ (mm)	Unit No.	Boundary dimensions (mm)									Bolt size	Bearings			Housing No.	Mass of Unit (kg)	Limiting load (N)	
		L	A	J	N	A ₁	H ₂ (Min)	B ₁	S	No.		Basic load rating (N)		Radial			Axial	
												Cr	Cor					
12	KHPF201A	81	14	63.5	7	4	49	28.6	6.5	M 6	KH201AE	9550	4800	PF3	0.23	2650	1320	
15	KHPF202A	81	14	63.5	7	4	49	28.6	6.5	M 6	KH202AE	9550	4800	PF3	0.22	2650	1320	
17	KHPF203A	81	14	63.5	7	4	49	28.6	6.5	M 6	KH203AE	9550	4800	PF3	0.21	2650	1320	
20	KHPF204A	90	16	71.5	9	4	56	31	7.5	M 8	KH204AE	12800	6600	PF4	0.29	3100	1520	
25	KHPF205A	95	18	76	9	4	60	31	7.5	M 8	KH205AE	14000	7900	PF5	0.39	3550	1750	
30	KHPF206A	113	18	90.5	11	5.2	71	35.7	9	M10	KH206AE	19600	11300	PF6	0.60	4900	2450	
35	KHPF207A	122	20	100	11	5.2	81	38.9	9.5	M10	KH207AE	25900	15400	PF7	0.82	6200	3100	

Pressed Steel Rhombic Flange Units

BPFL type
With set screws
Cylindrical bore
Shaft dia.: 12~35mm

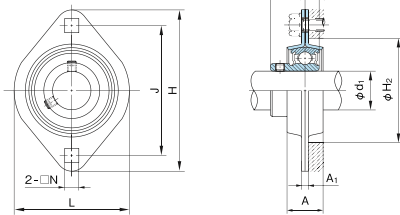

BPFL type

KHPFL type
With eccentric collar
Cylindrical bore
Shaft dia.: 12~35mm

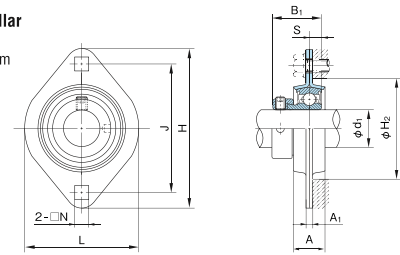

1N=0.102kgf

Shaft dia. d ₁ (mm)	Unit No.	Boundary dimensions (mm)										Bolt size	Bearings			Housing No.	Mass of Unit (kg)	Limiting load (N)	
		H	L	A	J	N	A ₁	H ₂	B	S	No.		Basic load rating (N)		Radial			Axial	
		Cr	Cor																
12	BPFL1	81	59	14	63.5	7	4	49	22	6	M 6	B1	9550	4800	PFL3	0.25	2650	640	
15	BPFL2	81	59	14	63.5	7	4	49	22	6	M 6	B2	9550	4800	PFL3	0.24	2650	640	
17	BPFL3	81	59	14	63.5	7	4	49	22	6	M 6	B3	9550	4800	PFL3	0.22	2650	640	
20	BPFL4	90	67	16	71.5	9	4	56	24.7	7	M 8	B4	12800	6600	PFL4	0.29	3100	740	
25	BPFL5	95	71	18	76	9	4	60	27	7.5	M 8	B5	14000	7900	PFL5	0.36	3550	900	
30	BPFL6	113	84	18	90.5	11	5.2	71	30.3	8	M10	B6	19600	11300	PFL6	0.56	4900	1200	
35	BPFL7	125	94	20	100	11	5.2	81	32.9	8.5	M10	B7	25900	15400	PFL7	0.70	6200	1500	

KHPFL type

1N=0.102kgf

Shaft dia. d ₁ (mm)	Unit No.	Boundary dimensions (mm)										Bolt size	Bearings			Housing No.	Mass of Unit (kg)	Limiting load (N)	
		H	L	A	J	N	A ₁	H ₂	B ₁	S	No.		Basic load rating (N)		Radial			Axial	
		Cr	Cor																
12	KHPFL201A	81	59	14	63.5	7	4	49	28.6	6.5	M 6	KH201AE	9550	4800	PFL3	0.27	2650	640	
15	KHPFL202A	81	59	14	63.5	7	4	49	28.6	6.5	M 6	KH202AE	9550	4800	PFL3	0.26	2650	640	
17	KHPFL203A	81	59	14	63.5	7	4	49	28.6	6.5	M 6	KH203AE	9550	4800	PFL3	0.25	2650	640	
20	KHPFL204A	90	67	16	71.5	9	4	56	31	7.5	M 8	KH204AE	12800	6600	PFL4	0.33	3100	740	
25	KHPFL205A	95	71	18	76	9	4	60	31	7.5	M 8	KH205AE	14000	7900	PFL5	0.40	3550	900	
30	KHPFL206A	113	84	18	90.5	11	5.2	71	35.7	9	M10	KH206AE	19600	11300	PFL6	0.62	4900	1200	
35	KHPFL207A	125	94	20	100	11	5.2	81	38.9	9.5	M10	KH207AE	25900	15400	PFL7	0.81	6200	1500	

Transformed Rhombic Flange Units

UCFA type
With set screws
Cylindrical bore
Shaft dia.:
12~55mm

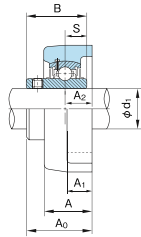
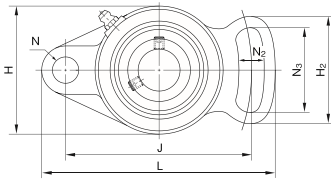

1N=0.102kgf

Shaft dia. d ₁ (mm)	Unit No.	Boundary dimensions (mm)														Bolt size	Bearings			Housing No.	Mass of Unit (kg)
		H	H ₂	L	A	J	N	N ₂	N ₃	A ₁	A ₂	A ₀	B	S	No.		Basic load rating (N)				
																	C _r	C _{0r}			
12	UCFA201	60	54	102	25.5	78	10	10	40	12	15	33.3	31	12.7	M 8	UC201	12800	6600	FA204	0.50	
15	UCFA202	60	54	102	25.5	78	10	10	40	12	15	33.3	31	12.7	M 8	UC202	12800	6600	FA204	0.49	
17	UCFA203	60	54	102	25.5	78	10	10	40	12	15	33.3	31	12.7	M 8	UC203	12800	6600	FA204	0.48	
20	UCFA204	60	54	102	25.5	78	10	10	40	12	15	33.3	31	12.7	M 8	UC204	12800	6600	FA204	0.46	
25	UCFA205	68	65	125	27	98	12	13	51	14	16	35.7	34	14.3	M10	UC205	14000	7900	FA205	0.66	
30	UCFA206	80	72	144	31	117	12	13	58	14	18	40.2	38.1	15.9	M10	UC206	19600	11300	FA206	1.0	
35	UCFA207	90	82	161	34	130	14	15	66	16	19	44.4	42.9	17.5	M12	UC207	25900	15400	FA207	1.4	
40	UCFA208	100	87	175	36	144	14	15	71	16	21	51.2	49.2	19	M12	UC208	29300	17900	FA208	1.7	
45	UCFA209	108	90	181	38	148	16	17	72	18	22	52.2	49.2	19	M14	UC209	33000	20500	FA209	2.0	
50	UCFA210	115	94	190	40	157	16	17	76	18	22	54.6	51.6	19	M14	UC210	35500	23200	FA210	2.4	
55	UCFA211	130	104	219	43	184	16	17	86	20	25	58.4	55.6	22.2	M14	UC211	43000	29400	FA211	3.4	

Remark: Grease nipple: 1/4-28UNF

Flange Units
UCFK type
With set screws
Cylindrical bore
 Shaft dia.: 12~50mm

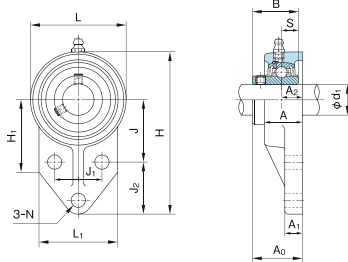

1N=0.102kgf

Shaft dia. d1 (mm)	Unit No.	Boundary dimensions (mm)															Bolt size	Bearings			Housing No.	Mass of Unit (kg)
		H	H1	L	L1	A	J	J1	J2	N	A1	A2	A0	B	S	No.		Basic load rating (N)				
		Cr	Cor																			
12	UCFK201	110	52	62	52	25.5	42	32	27	10	13	15	33.3	31	12.7	M 8	UC201	12800	6600	FK204	0.60	
15	UCFK202	110	52	62	52	25.5	42	32	27	10	13	15	33.3	31	12.7	M 8	UC202	12800	6600	FK204	0.58	
17	UCFK203	110	52	62	52	25.5	42	32	27	10	13	15	33.3	31	12.7	M 8	UC203	12800	6600	FK204	0.57	
20	UCFK204	110	52	62	52	25.5	42	32	27	10	13	15	33.3	31	12.7	M 8	UC204	12800	6600	FK204	0.55	
25	UCFK205	116	52	68	56	27	45	34	27	10	13	16	35.7	34	14.3	M 8	UC205	14000	7900	FK205	0.66	
30	UCFK206	130	55	78	65	31	50	40	29	10	13	18	40.2	38.1	15.9	M 8	UC206	19600	11300	FK206	0.93	
35	UCFK207	144	62	90	70	34	55	46	32	10	15	19	44.4	42.9	17.5	M 8	UC207	25900	15400	FK207	1.3	
40	UCFK208	164	72	100	78	36	60	50	41	12	16	21	51.2	49.2	19	M10	UC208	29300	17900	FK208	1.7	
45	UCFK209	174	76	106	80	38	65	54	43	12	18	22	52.2	49.2	19	M10	UC209	33000	20500	FK209	1.9	
50	UCFK210	184	82	112	86	40	68	58	46	12	18	22	54.6	51.6	19	M10	UC210	35500	23200	FK210	2.2	

Remark: Grease nipple: 1/4-28UNF

Take-up Units
UCT type With set screws Cylindrical bore
 Shaft dia.: 12~60mm

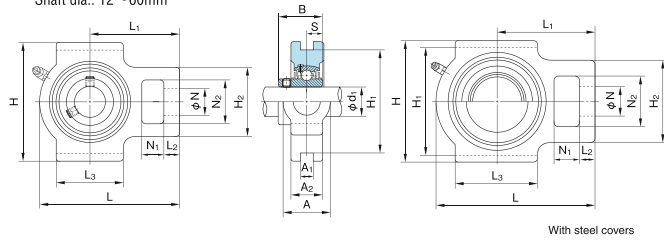

With steel covers

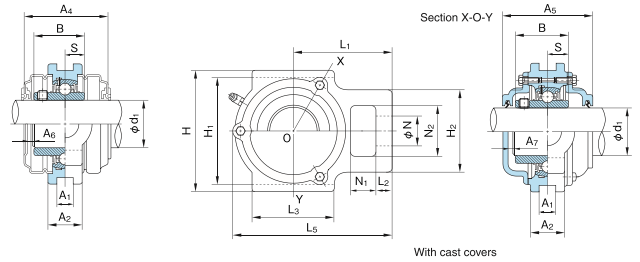

With cast covers

Shaft dia. d ₁ (mm)	Unit No.	Boundary dimensions (mm)																	Bearings			Housing No.	Unit No. with steel covers		Unit No. with cast covers		Mass of Unit (kg)			
		A	A ₁	A ₂	H	H ₁	H ₂	L	L ₅	L ₁	L ₂	L ₃	N	N ₁	N ₂	B	S	A ₄	A ₅	A ₆	A ₇		No.	Basic load rating (N)		Covers with rubber seal (End cover on one side)	Covers with rubber seal (End cover on one side)	standard	With steel cover	With cast cover
		Cr		Cor		No.			No.			No.			No.															
12	UCT201	32	12	21	89	76	51	94	96	61	10	51	19	16	32	31	12.7	56	62	8	6	UC201	12800	6600	T204	UCT201C(E)	CUCT201C(CE)	0.79	0.85	1.2
15	UCT202	32	12	21	89	76	51	94	96	61	10	51	19	16	32	31	12.7	56	62	8	6	UC202	12800	6600	T204	UCT202C(E)	CUCT202C(CE)	0.77	0.83	1.2
17	UCT203	32	12	21	89	76	51	94	96	61	10	51	19	16	32	31	12.7	56	62	8	6	UC203	12800	6600	T204	UCT203C(E)	CUCT203C(CE)	0.76	0.82	1.2
20	UCT204	32	12	21	89	76	51	94	96	61	10	51	19	16	32	31	12.7	56	62	8	6	UC204	12800	6600	T204	UCT204C(E)	CUCT204C(CE)	0.74	0.80	1.2
25	UCT205	32	12	24	89	76	51	97	100	62	10	51	19	16	32	34	14.3	63	70	11	9	UC205	14000	7900	T205	UCT205C(E)	CUCT205C(CE)	0.82	0.89	1.5
	UCTX05	37	12	28	102	89	56	113	—	70	10	57	22	16	37	38.1	15.9	65	—	9	—	UCX05	19600	11300	TX05	UCTX05C(E)	—	1.3	1.3	—
	UCT305	36	12	26	89	80	62	122	122	76	12	65	26	16	36	38	15	—	78	—	10	UC305	21300	10900	T305	—	CUCT305C(CE)	1.4	—	2.0
30	UCT206	37	12	28	102	89	56	113	113	70	10	57	22	16	37	38.1	15.9	65	74	9	8	UC206	19600	11300	T206	UCT206C(E)	CUCT206C(CE)	1.3	1.4	2.0
	UCTX06	37	12	30	102	89	64	129	—	78	13	64	22	16	37	42.9	17.5	70	—	8	—	UCX06	25900	15400	TX06	UCTX06C(E)	—	1.6	1.6	—
	UCT306	41	16	28	100	90	70	137	137	85	14	74	28	18	41	43	17	—	84	—	10	UC306	26800	15000	T306	—	CUCT306C(CE)	1.8	—	2.5
35	UCT207	37	12	30	102	89	64	129	129	78	13	64	22	16	37	42.9	17.5	70	80	8	8	UC207	25900	15400	T207	UCT207C(E)	CUCT207C(CE)	1.6	1.8	2.6
	UCTX07	49	16	36	114	102	83	144	—	88	15	83	29	19	49	49.2	19	83	—	10	—	UCX07	29300	17900	TX07	UCTX07C(E)	—	2.6	2.6	—
	UCT307	45	16	32	111	100	75	150	150	94	15	80	30	20	45	48	19	—	90	—	10	UC307	33500	19200	T307	—	CUCT307C(CE)	2.4	—	3.3
40	UCT208	49	16	33	114	102	83	144	144	88	16	83	29	19	49	49.2	19	82	90	10	8	UC208	29300	17900	T208	UCT208C(E)	CUCT208C(CE)	2.4	2.5	3.4
	UCTX08	49	16	36	117	102	83	144	—	87	15	83	29	19	49	49.2	19	82	—	10	—	UCX08	33000	20500	TX08	UCTX08C(E)	—	2.6	2.6	—
	UCT308	50	18	34	124	112	83	162	162	100	17	89	32	22	50	52	19	—	100	—	11	UC308	40500	23900	T308	—	CUCT308C(CE)	3.0	—	4.0
45	UCT209	49	16	35	117	102	83	144	145	87	16	83	29	19	49	49.2	19	82	90	10	8	UC209	33000	20500	T209	UCT209C(E)	CUCT209C(CE)	2.4	2.6	3.6
	UCTX09	49	16	38	117	102	83	149	—	90	16	86	29	19	49	51.6	19	87	—	9	—	UCX09	35500	23200	TX09	UCTX09C(E)	—	2.8	3.0	—
	UCT309	55	18	38	138	125	90	178	178	110	18	97	34	24	55	57	22	—	106	—	12	UC309	51500	29500	T309	—	CUCT309C(CE)	4.1	—	5.5
50	UCT210	49	16	37	117	102	83	149	151	90	16	86	29	19	49	51.6	19	87	98	9	10	UC210	35500	23200	T210	UCT210C(E)	CUCT210C(CE)	2.5	2.8	4.1
	UCTX10	64	22	42	146	130	102	171	—	106	19	95	35	25	64	55.6	22.2	88	—	9	—	UCX10	43000	29400	TX10	UCTX10C(E)	—	4.4	4.6	—
	UCT310	61	20	40	151	140	98	191	191	117	20	106	37	27	61	61	22	—	114	—	12	UC310	61500	38200	T310	—	CUCT310C(CE)	5.2	—	6.8
55	UCT211	64	22	38	146	130	102	171	174	106	19	95	35	25	64	55.6	22.2	88	100	9	10	UC211	43000	29400	T211	UCT211C(E)	CUCT211C(CE)	4.0	4.3	5.6
	UCTX11	64	22	44	146	130	102	194	—	119	19	102	35	32	64	65.1	25.4	100	—	9	—	UCX11	52500	36100	TX11	UCTX11C(E)	—	5.2	5.5	—
	UCT311	66	22	44	163	150	105	207	207	127	21	115	39	29	66	66	25	—	120	—	13	UC311	71500	44800	T311	—	CUCT311C(CE)	6.4	—	8.3
60	UCT212	64	22	42	146	130	102	194	194	119	19	102	35	32	64	65.1	25.4	102	114	10	11	UC212	52500	36100	T212	UCT212C(E)	CUCT212C(CE)	5.1	5.5	7.0
	UCTX12	70	26	48	167	151	111	224	—	137	21	121	41	32	70	65.1	25.4	104	—	11	—	UCX12	57500	40000	TX12	UCTX12C(E)	—	7.2	7.4	—
	UCT312	71	22	46	178	160	113	220	220	135	23	123	41	31	71	71	26	—	130	—	14	UC312	81500	52000	T312	—	CUCT312C(CE)	7.6	—	10.7

Remarks: 1. Grease nipple: 1/4-28UNF

Remarks: 2. Examples of unit numbers with covers:

- With steel cover { Covers with rubber seal on both sides :UCT210C
- { An end cover and a cover with rubber seal :UCT210E
- { Covers with rubber seal on both sides :CUCT210C
- With cast cover { An end cover and a cover with rubber seal :CUCT210CE

Take-up Units

UCT type With set screws Cylindrical bore
Shaft dia.: 65~140mm

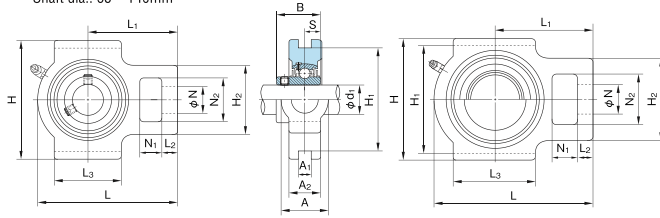

With steel covers

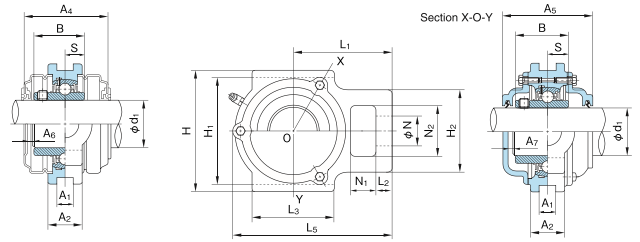

With cast covers

Shaft dia. d1 (mm)	Unit No.	Boundary dimensions (mm)																	Bearings			Housing No.	Unit No. with steel covers		Mass of Unit (kg)					
		A	A1	A2	H	H1	H2	L	L3	L1	L2	L3	N	N1	N2	B	S	A4	A5	A6	A7		No.	Basic load rating (N)		Covers with rubber seal (End cover on one side)	Covers with rubber seal (End cover on one side)	standard	With steel cover	With cast cover
		Cr	Cor																											
65	UCT213	70	26	44	167	151	111	224	224	137	21	121	41	32	70	65.1	25.4	102	118	10	13	UC213	57500	40000	T213	UCT213C(E)	UCT213C(CE)	7.0	7.5	9.2
	UCTX13	70	26	48	167	151	111	224	—	137	21	121	41	32	70	74.6	30.2	—	—	—	—	UCX13	62000	44000	TX13	—	—	7.4	—	—
	UCT313	80	26	50	190	170	116	238	242	146	25	134	43	32	70	75	30	—	140	—	17	UC313	92500	59700	T313	—	UCT313C(CE)	9.2	—	12.9
70	UCT214	70	26	46	167	151	111	224	224	137	21	121	41	32	70	74.6	30.2	—	134	—	16	UC214	62000	44000	T214	—	UCT214C(CE)	7.1	—	9.8
	UCTX14	70	26	48	167	151	111	232	—	140	21	121	41	32	70	77.8	33.3	—	—	—	—	UCX14	66000	48200	TX14	—	—	7.7	—	—
	UCT314	90	26	52	202	180	130	252	256	155	25	140	46	36	85	78	33	—	140	—	17	UC314	104000	68000	T314	—	UCT314C(CE)	11.2	—	15.0
75	UCT215	70	26	48	167	151	111	232	232	140	21	121	41	32	70	77.8	33.3	—	136	—	17	UC215	66000	48200	T215	—	UCT215C(CE)	7.5	—	10.2
	UCTX15	70	28	48	184	165	111	235	—	140	21	121	41	32	70	82.6	33.3	—	—	—	—	UCX15	72500	53000	TX15	—	—	8.4	—	—
	UCT315	90	26	55	216	192	132	262	266	160	25	150	46	36	85	82	32	—	150	—	17	UC315	114000	76900	T315	—	UCT315C(CE)	13.0	—	17.2
80	UCT216	70	26	51	184	165	111	235	236	140	21	121	41	32	70	82.6	33.3	—	146	—	15	UC216	72500	53000	T216	—	UCT216C(CE)	8.5	—	12.4
	UCTX16	73	28	54	198	173	124	260	—	162	28	157	48	38	73	85.7	34.1	—	—	—	—	UCX16	83500	61800	TX16	—	—	11.3	—	—
	UCT316	102	30	60	230	204	150	282	285	174	28	160	53	42	98	86	34	—	154	—	17	UC316	123000	86400	T316	—	UCT316C(CE)	15.6	—	20.7
85	UCT217	73	30	54	198	173	124	260	264	162	29	157	48	38	73	85.7	34.1	—	150	—	15	UC217	83500	61800	T217	—	UCT217C(CE)	11.2	—	15.4
	UCTX17	73	28	54	198	173	124	260	—	162	28	157	48	38	73	96	39.7	—	—	—	—	UCX17	95500	71400	TX17	—	—	11.0	—	—
	UCT317	102	32	64	240	214	152	298	302	183	30	170	53	42	98	96	40	—	164	—	18	UC317	132000	96500	T317	—	UCT317C(CE)	19.3	—	24.4
90	UCT318	110	32	66	255	228	160	312	316	192	30	175	57	46	106	96	40	—	168	—	20	UC318	143000	107200	T318	—	UCT318C(CE)	21.2	—	27.4
	UCT319	110	35	72	270	240	165	322	326	197	31	180	57	46	106	103	41	—	180	—	20	UC319	153000	118400	T319	—	UCT319C(CE)	24.4	—	31.3
	UCT320	120	35	75	290	260	175	345	349	210	32	200	59	48	115	108	42	—	190	—	21	UC320	173000	140400	T320	—	UCT320C(CE)	30.6	—	37.9
105	UCT321	120	35	75	290	260	175	345	354	210	32	200	59	48	115	112	44	—	194	—	21	UC321	183000	153100	T321	—	UCT321C(CE)	30.2	—	38.2
	UCT322	130	38	80	320	285	185	385	387	235	38	215	65	52	125	117	46	—	210	—	26	UC322	205000	178800	T322	—	UCT322C(CE)	38.8	—	48.2
	UCT324	140	45	90	355	320	210	432	432	267	42	230	70	60	140	126	51	—	220	—	25	UC324	207000	184800	T324	—	UCT324C(CE)	54.6	—	67.3
130	UCT326	150	50	100	385	350	220	465	465	285	45	240	75	65	150	135	54	—	230	—	24	UC326	229000	214300	T326	—	UCT326C(CE)	68.4	—	83.5
	UCT328	155	50	100	415	380	230	515	515	315	50	255	80	70	160	145	59	—	240	—	24	UC328	255000	246000	T328	—	UCT328C(CE)	83.2	—	101

Remarks: 1. Grease nipple: 1/4-28UNF for bore number 13 and under
PF1/8 for bore number 14 and over

Remarks: 2. Examples of unit numbers with covers:
With steel cover { Covers with rubber seal on both sides :UCT213C
An end cover and a cover with rubber seal :UCT213E
With cast cover { Covers with rubber seal on both sides :UCT213C
An end cover and a cover with rubber seal :UCT213CE

Take-up Units
UKT+H type With adapter assembly Tapered bore
 Shaft dia.: 20~60mm

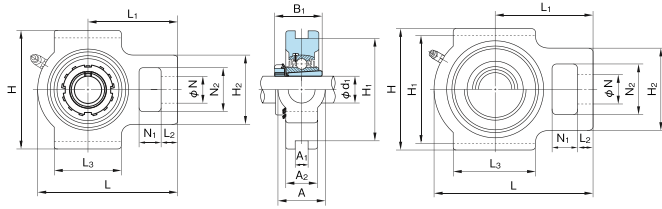

With steel covers

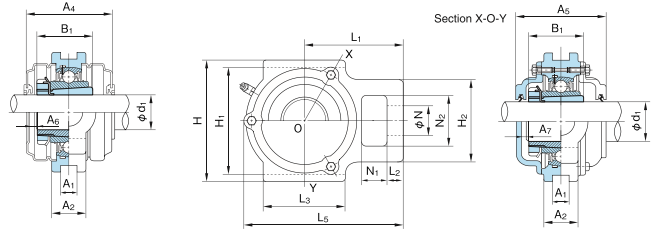

With cast covers

Shaft dia. d ₁ (mm)	Unit No.	Boundary dimensions (mm)																	Bearings			Housing No.	Unit No. with steel covers		Unit No. with cast covers		Mass of Unit (kg)			
		A	A ₁	A ₂	H	H ₁	H ₂	L	L ₃	L ₁	L ₂	L ₃	N	N ₁	N ₂	B ₁	A ₄	A ₅	A ₆	A ₇	No.		Basic load rating (N)	Cr	Cor	Covers with rubber seal (End cover on one side)	Covers with rubber seal (End cover on one side)	standard	With steel cover	With cast cover
																			1N=0.102kgf											
20	UKT205+H2305	32	12	24	89	76	51	97	100	62	10	51	19	16	32	35	63	70	11	9	UK205+H2305	14000	7900	T205	UKT205(E)+H2305	CUKT205(CE)+H2305	0.83	0.94	1.6	
	UKTX05+H2305	37	12	28	102	89	56	113	—	70	10	57	22	16	37	35	65	—	10	—	UKX05+H2305	19600	11300	TX05	UKTX05(E)+H2305	—	1.3	1.3	—	
	UKT305+H2305	36	12	26	89	80	62	122	122	76	12	65	26	16	36	35	—	78	—	12	UK305+H2305	21300	10900	T305	—	CUKT305(CE)+H2305	1.4	—	2.1	
25	UKT206+H2306	37	12	28	102	89	56	113	113	70	10	57	22	16	37	38	65	74	10	10	UK206+H2306	19600	11300	T206	UKT206(E)+H2306	CUKT206(CE)+H2306	1.4	1.5	2.1	
	UKTX06+H2306	37	12	30	102	89	64	129	—	78	13	64	22	16	37	38	70	—	12	—	UKX06+H2306	25900	15400	TX06	UKTX06(E)+H2306	—	1.7	1.7	—	
	UKT306+H2306	41	16	28	100	90	70	137	137	85	14	74	28	18	41	38	—	84	—	13	UK306+H2306	26800	15000	T306	—	CUKT306(CE)+H2306	1.8	—	2.6	
30	UKT207+H2307	37	12	30	102	89	64	129	129	78	13	64	22	16	37	43	70	80	11	11	UK207+H2307	25900	15400	T207	UKT207(E)+H2307	CUKT207(CE)+H2307	1.7	1.9	2.7	
	UKTX07+H2307	49	16	36	114	102	83	144	—	88	15	83	29	19	49	43	83	—	17	—	UKX07+H2307	29300	17900	TX07	UKTX07(E)+H2307	—	2.6	2.6	—	
	UKT307+H2307	45	16	32	111	100	75	150	150	94	15	80	30	20	45	43	—	90	—	14	UK307+H2307	33500	19200	T307	—	CUKT307(CE)+H2307	2.5	—	3.4	
35	UKT208+H2308	49	16	33	114	102	83	144	144	88	16	83	29	19	49	46	82	90	15	14	UK208+H2308	29300	17900	T208	UKT208(E)+H2308	CUKT208(CE)+H2308	2.5	2.6	3.5	
	UKTX08+H2308	49	16	36	117	102	83	144	—	87	15	83	29	19	49	46	82	—	15	—	UKX08+H2308	33000	20500	TX08	UKTX08(E)+H2308	—	2.6	2.6	—	
	UKT308+H2308	50	18	34	124	112	83	162	162	100	17	89	32	22	50	46	—	100	—	17	UK308+H2308	40500	23900	T308	—	CUKT308(CE)+H2308	3.1	—	4.1	
40	UKT209+H2309	49	16	35	117	102	83	144	145	87	16	83	29	19	49	50	82	90	14	13	UK209+H2309	33000	20500	T209	UKT209(E)+H2309	CUKT209(CE)+H2309	2.5	2.7	3.8	
	UKTX09+H2309	49	16	38	117	102	83	149	—	90	16	86	29	19	49	50	87	—	16	—	UKX09+H2309	35500	23200	TX09	UKTX09(E)+H2309	—	2.8	3.0	—	
	UKT309+H2309	55	18	38	138	125	90	178	178	110	18	97	34	24	55	50	—	106	—	17	UK309+H2309	51500	29500	T309	—	CUKT309(CE)+H2309	4.1	—	5.6	
45	UKT210+H2310	49	16	37	117	102	83	149	151	90	16	86	29	19	49	55	87	98	15	15	UK210+H2310	35500	23200	T210	UKT210(E)+H2310	CUKT210(CE)+H2310	2.7	3.0	4.3	
	UKTX10+H2310	64	22	42	146	130	102	171	—	106	19	95	35	25	64	55	88	—	14	—	UKX10+H2310	43000	29400	TX10	UKTX10(E)+H2310	—	4.4	4.6	—	
	UKT310+H2310	61	20	40	151	140	98	191	191	117	20	106	37	27	61	55	—	114	—	19	UK310+H2310	61500	38200	T310	—	CUKT310(CE)+H2310	5.3	—	7.1	
50	UKT211+H2311	64	22	38	146	130	102	171	174	106	19	95	35	25	64	59	88	100	14	15	UK211+H2311	43000	29400	T211	UKT211(E)+H2311	CUKT211(CE)+H2311	4.1	4.5	5.8	
	UKTX11+H2311	64	22	44	146	130	102	194	—	119	19	102	35	32	64	59	100	—	19	—	UKX11+H2311	52500	36100	TX11	UKTX11(E)+H2311	—	5.1	5.3	—	
	UKT311+H2311	66	22	44	163	150	105	207	207	127	21	115	39	29	66	59	—	120	—	20	UK311+H2311	71500	44800	T311	—	CUKT311(CE)+H2311	6.4	—	8.4	
55	UKT212+H2312	64	22	42	146	130	102	194	194	119	19	102	35	32	64	62	102	114	19	20	UK212+H2312	52500	36100	T212	UKT212(E)+H2312	CUKT212(CE)+H2312	5.1	5.6	7.2	
	UKTX12+H2312	70	26	48	167	151	111	224	—	137	21	121	41	32	70	62	104	—	19	—	UKX12+H2312	57500	40000	TX12	UKTX12(E)+H2312	—	7.1	7.3	—	
	UKT312+H2312	71	22	46	178	160	113	220	220	135	23	123	41	31	71	62	—	130	—	23	UK312+H2312	81500	52000	T312	—	CUKT312(CE)+H2312	7.6	—	10.8	
60	UKT213+H2313	70	26	44	167	151	111	224	224	137	21	121	41	32	70	65	102	118	17	20	UK213+H2313	57500	40000	T213	UKT213(E)+H2313	CUKT213(CE)+H2313	7.1	7.6	9.5	
	UKTX13+H2313	70	26	48	167	151	111	224	—	137	21	121	41	32	70	65	—	—	—	—	UKX13+H2313	62000	44000	TX13	—	—	7.2	—	—	
	UKT313+H2313	80	26	50	190	170	116	238	242	146	25	134	43	32	70	65	—	140	—	24	UK313+H2313	92500	59700	T313	—	CUKT313(CE)+H2313	9.1	—	12.9	

Remarks: 1. Grease nipple: 1/4-28UNF

Remarks: 2. Examples of unit numbers with covers:

- With steel cover: { Covers with rubber seal on both sides :UKP210C+H2310
- { An end cover and a cover with rubber seal :UKT210E+H2310
- { Covers with rubber seal on both sides :LKP210C+H2310
- With cast cover: { An end cover and a cover with rubber seal :CUKT210CE+H2310

Take-up Units
UKT+H type With adapter assembly Tapered bore
 Shaft dia.: 65~125mm

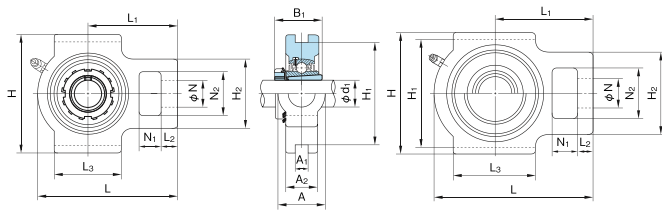

With steel covers

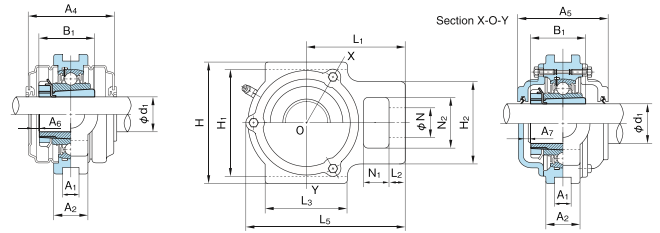

With cast covers

1N=0.102kgf

Shaft dia. d ₁ (mm)	Unit No.	Boundary dimensions (mm)																	Bearings			Housing No.	Unit No. with steel covers		Unit No. with cast covers		Mass of Unit (kg)		
		A	A ₁	A ₂	H	H ₁	H ₂	L	L ₃	L ₁	L ₂	L ₃	N	N ₁	N ₂	B ₁	A ₄	A ₅	A ₆	A ₇	No.		Basic load rating (N)	Cr	Cor	Covers with rubber seal (End cover on one side)	Covers with rubber seal (End cover on one side)	standard	With steel cover
65	UKT215+H2315	70	26	48	167	151	111	232	232	140	21	121	41	32	70	73	—	136	—	26	UK215+H2315	66000	48200	T215	—	CUKT215C(CE)+H2315	7.9	—	10.7
	UKTX15+H2315	70	28	48	184	165	111	235	—	140	21	121	41	32	70	73	—	—	—	—	UKX15+H2315	72500	53000	TX15	—	—	8.4	—	—
	UKT315+H2315	90	26	55	216	192	132	262	266	160	25	150	46	36	85	73	—	150	—	25	UK315+H2315	114000	76900	T315	—	CUKT315C(CE)+H2315	13.1	—	17.6
70	UKT216+H2316	70	26	51	184	165	111	235	236	140	21	121	41	32	70	78	—	146	—	26	UK216+H2316	72500	53000	T216	—	CUKT216C(CE)+H2316	8.9	—	12.9
	UKTX16+H2316	73	28	54	198	173	124	260	—	162	28	157	48	38	73	78	—	—	—	—	UKX16+H2316	83500	61800	TX16	—	—	11.4	—	—
	UKT316+H2316	102	30	60	230	204	150	282	285	174	28	160	53	42	98	78	—	154	—	23	UK316+H2316	123000	86400	T316	—	CUKT316C(CE)+H2316	15.9	—	21.1
75	UKT217+H2317	73	30	54	198	173	124	260	264	162	29	157	48	38	73	82	—	150	—	26	UK217+H2317	83500	61800	T217	—	CUKT217C(CE)+H2317	11.7	—	16.1
	UKTX17+H2317	73	28	54	198	173	124	260	—	162	28	157	48	38	73	82	—	—	—	—	UKX17+H2317	95500	71400	TX17	—	—	10.9	—	—
	UKT317+H2317	102	32	64	240	214	152	298	302	183	30	170	53	42	98	82	—	164	—	28	UK317+H2317	132000	96500	T317	—	CUKT317C(CE)+H2317	19.3	—	24.6
80	UKT318+H2318	110	32	66	255	228	160	312	316	192	30	175	57	46	106	86	—	168	—	26	UK318+H2318	143000	107200	T318	—	CUKT318C(CE)+H2318	21.4	—	28.4
	UKT319+H2319	110	35	72	270	240	165	322	326	197	31	180	57	46	106	90	—	180	—	30	UK319+H2319	153000	118400	T319	—	CUKT319C(CE)+H2319	24.4	—	31.5
	UKT320+H2320	120	35	75	290	260	175	345	349	210	32	200	59	48	115	97	—	190	—	31	UK320+H2320	173000	140400	T320	—	CUKT320C(CE)+H2320	30.6	—	38.5
100	UKT322+H2322	130	38	80	320	285	185	385	387	235	38	215	65	52	125	105	—	210	—	36	UK322+H2322	205000	178800	T322	—	CUKT322C(CE)+H2322	38.9	—	48.9
	UKT324+H2324	140	45	90	355	320	210	432	432	267	42	230	70	60	140	112	—	220	—	35	UK324+H2324	207000	184800	T324	—	CUKT324C(CE)+H2324	54.1	—	67.5
	UKT326+H2326	150	50	100	385	350	220	465	465	285	45	240	75	65	150	121	—	230	—	36	UK326+H2326	229000	214300	T326	—	CUKT326C(CE)+H2326	68.7	—	85.0
125	UKT328+H2328	155	50	100	415	380	230	515	515	315	50	255	80	70	160	131	—	240	—	37	UK328+H2328	255000	246000	T328	—	CUKT328C(CE)+H2328	83.5	—	103

Remarks: 1. Grease nipple: PF1/8

Remarks: 2. Examples of unit numbers with covers:

With cast cover { Covers with rubber seal on both sides :CUKT315C+H2315
 An end cover and a cover with rubber seal :CUKT315CE+H2315

Take-up Units
BT200 type
 With set screws
 Cylindrical bore
 Shaft dia.: 20~35mm

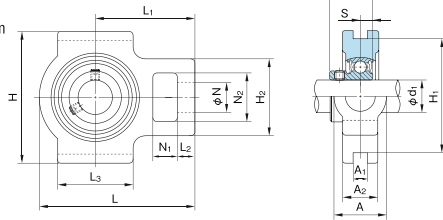

1N=0.102kgf

Shaft dia. d1 (mm)	Unit No.	Boundary dimensions (mm)															Bearings			Housing No.	Mass of Unit (kg)
		A	A1	A2	H	H1	H2	L	L1	L2	L3	N	N1	N2	B	S	No.	Basic load rating (N)			
		Cr		Cor																	
20	BT204	32	12	21	89	76	51	94	61	10	51	19	16	32	24.7	7	B4	12800	6600	T204 G00	0.70
25	BT205	32	12	24	89	76	51	97	62	10	51	19	16	32	27	7.5	B5	14000	7900	T205 G00	0.79
30	BT206	37	12	28	102	89	56	113	70	10	57	22	16	37	30.3	8	B6	19600	11300	T206 G00	1.2
35	BT207	37	12	30	102	89	64	129	78	13	64	22	16	37	32.9	8.5	B7	25900	15400	T207 G00	1.6

Take-up Units
UCT200+WB type
 With pressed steel frame
 With set screws
 Cylindrical bore
 Shaft dia.: 12~65mm

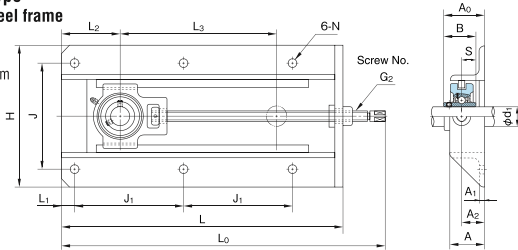

Shaft dia. d ₁ (mm)	Unit No.	Boundary dimensions (mm)															Bolt size	Frame No.	Bearings			Mass of Unit (kg)	
		H	L	J	J ₁	N	L ₁	L ₂	L ₃	G ₂	L ₄	A	A ₁	A ₂	A ₀	B			S	No.	Basic load rating (N)		
		Cr	Cor																				
12	UCT201+WB	199	317	154	117	12	19	83	150	Tr16	367	50	29	6	47.3	31	12.7	M10	WB205	UC201	12800	6600	5.0
15	UCT202+WB	199	317	154	117	12	19	83	150	Tr16	367	50	29	6	47.3	31	12.7	M10	WB205	UC202	12800	6600	5.0
17	UCT203+WB	199	317	154	117	12	19	83	150	Tr16	367	50	29	6	47.3	31	12.7	M10	WB205	UC203	12800	6600	5.0
20	UCT204+WB	199	317	154	117	12	19	83	150	Tr16	367	50	29	6	47.3	31	12.7	M10	WB205	UC204	12800	6600	5.0
25	UCT205+WB	199	317	154	117	12	19	83	150	Tr16	368	50	29	6	48.7	34	14.3	M10	WB205	UC205	14000	7900	5.0
30	UCT206+WB	212	337	166	127	12	19	95	150	Tr18	396	50	30	6	52.2	38.1	15.9	M10	WB206	UC206	19600	11300	5.9
35	UCT207+WB	212	429	166	173	12	19	99	230	Tr18	490	50	30	6	55.4	42.9	17.5	M10	WB207	UC207	25900	15400	7.9
40	UCT208+WB	233	520	192	219	15	22	108	300	Tr26	591	50	30	6	60.2	49.2	19	M12	WB210	UC208	29300	17900	11.1
45	UCT209+WB	233	520	192	219	15	22	108	300	Tr26	590	50	30	6	60.2	49.2	19	M12	WB210	UC209	33000	20500	11.1
50	UCT210+WB	233	520	192	219	15	22	108	300	Tr26	593	50	30	6	62.6	51.6	19	M12	WB210	UC210	35500	23200	11.2
55	UCT211+WB	301	542	240	230	15	22	114	300	Tr30	631	65	38	6	71.4	55.6	22.2	M12	WB211	UC211	43000	29400	17.3
60	UCT212+WB	301	568	240	243	15	22	127	300	Tr30	657	65	38	6	77.7	65.1	25.4	M12	WB212	UC212	52500	36100	18.7
65	UCT213+WB	322	606	260	260	15	22	144	300	Tr36	699	65	38	6	77.7	65.1	25.4	M12	WB213	UC213	57500	40000	23.4

Remark: Grease nipple: 1/4-28UNF

Take-up Units

UCTL200+WL type With frame With set screws Cylindrical bore

Shaft dia.: 20~45mm

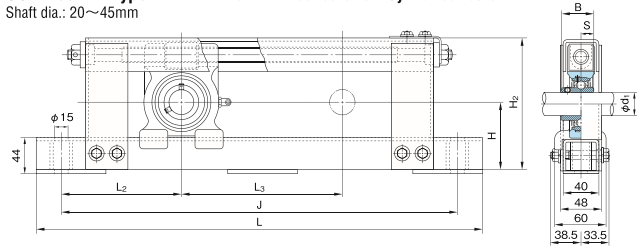

1N=0.102kgf

Shaft dia. d ₁ (mm)	Unit No.	Boundary dimensions (mm)									Bolt size	Bearings			Housing No.	Frame No.	Mass of Unit (kg)
		H	H ₂	L	J	L ₂	L ₃	B	S	No.		Basic load rating (N)					
												Cr	Cor				
20	<i>UCTL204+WL100</i>	77	146	430	370	135	100	31	12.7	M12	UC204	12800	6600	TL204	<i>WL204-100</i>	5.6	
	530			470	200		<i>WL204-200</i>								6.3		
	630			570	300		<i>WL204-300</i>								7.0		
	730			670	400		<i>WL204-400</i>								7.7		
25	<i>UCTL205+WL100</i>	82	156	440	380	140	100	34	14.3	M12	UC205	14000	7900	TL205	<i>WL205-100</i>	6.0	
	540			480	200		<i>WL205-200</i>								6.7		
	640			580	300		<i>WL205-300</i>								7.4		
	740			680	400		<i>WL205-400</i>								8.1		
30	<i>UCTL206+WL100</i>	87	166	450	390	145	100	38.1	15.9	M12	UC206	19600	11300	TL206	<i>WL206-100</i>	6.5	
	550			490	200		<i>WL206-200</i>								7.2		
	650			590	300		<i>WL206-300</i>								7.9		
	750			690	400		<i>WL206-400</i>								8.6		
35	<i>UCTL207+WL100</i>	92	176	460	400	150	100	42.9	17.5	M12	UC207	25900	15400	TL207	<i>WL207-100</i>	7.1	
	560			500	200		<i>WL207-200</i>								7.8		
	660			600	300		<i>WL207-300</i>								8.5		
	760			700	400		<i>WL207-400</i>								9.2		
40	<i>UCTL208+WL100</i>	97	186	470	410	155	100	49.2	19	M12	UC208	29300	17900	TL208	<i>WL208-100</i>	7.8	
	570			510	200		<i>WL208-200</i>								8.5		
	670			610	300		<i>WL208-300</i>								9.2		
	770			710	400		<i>WL208-400</i>								9.9		
45	<i>UCTL209+WL100</i>	100	192	480	420	160	100	49.2	19	M12	UC209	33000	20500	TL209	<i>WL209-100</i>	8.2	
	580			520	200		<i>WL209-200</i>								8.9		
	680			620	300		<i>WL209-300</i>								9.6		
	780			720	400		<i>WL209-400</i>								10.3		

Remarks: 1. Please contact NACHI for unit numbers appearing in italic.
2. Grease nipple: PF1/8

Take-up Units
UCTU200+WU type
 With frame
 With set screws
 Cylindrical bore
 Shaft dia.:
 40~60mm

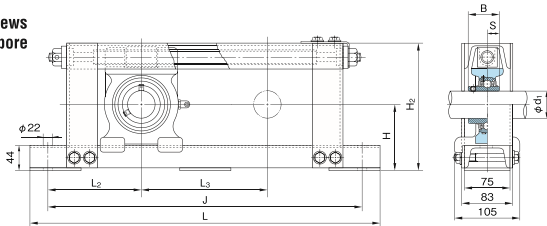

1N=0.102kgf

Shaft dia. d ₁ (mm)	Unit No.	Boundary dimensions (mm)									Bolt size	Bearings			Housing No.	Frame No.	Mass of Unit (kg)
		H	H ₂	L	J	L ₂	L ₃	B	S	No.		Basic load rating (N)					
												Cr	Cor				
40	UCTU208+WU500			870	810		500									WU208-500	19.0
	UCTU208+WU600			970	910		600									WU208-600	20.6
	UCTU208+WU700	97	190	1070	1010	155	700	49.2	19	M18	UC208	29300	17900	TC208	WU208-700	22.2	
	UCTU208+WU800			1170	1110		800									WU208-800	23.8
	UCTU208+WU900			1270	1210		900									WU208-900	25.3
45	UCTU209+WU500			880	820		500									WU209-500	19.7
	UCTU209+WU600			980	920		600									WU209-600	21.3
	UCTU209+WU700	102	200	1080	1020	160	700	19.2	19	M18	UC209	33000	20500	TC209	WU209-700	22.9	
	UCTU209+WU800			1180	1120		800									WU209-800	24.5
	UCTU209+WU900			1280	1220		900									WU209-900	26.1
50	UCTU210+WU500			890	830		500									WU210-500	20.5
	UCTU210+WU600			990	930		600									WU210-600	22.2
	UCTU210+WU700	107	210	1090	1030	165	700	51.6	19	M18	UC210	35500	23200	TC210	WU210-700	23.8	
	UCTU210+WU800			1190	1130		800									WU210-800	25.4
	UCTU210+WU900			1290	1230		900									WU210-900	27.0
55	UCTU211+WU500			910	850		500									WU211-500	22.4
	UCTU211+WU600			1010	950		600									WU211-600	23.7
	UCTU211+WU700	115	230	1110	1050	175	700	55.6	22.2	M18	UC211	43000	29400	TC211	WU211-700	25.8	
	UCTU211+WU800			1210	1150		800									WU211-800	27.4
	UCTU211+WU900			1310	1250		900									WU211-900	29.1
60	UCTU212+WU500			920	860		500									WU212-500	23.9
	UCTU212+WU600			1020	960		600									WU212-600	25.6
	UCTU212+WU700	120	240	1120	1060	180	700	65.1	25.4	M18	UC212	52500	36100	TC212	WU212-700	27.2	
	UCTU212+WU800			1220	1160		800									WU212-800	28.9
	UCTU212+WU900			1320	1260		900									WU212-900	30.6

Remarks: 1. Please contact NACHI for unit numbers appearing in italic.
 2. Grease nipple: PF1/8

Take-up Units
UCTU300+WU type
 With frame
 With set screws
 Cylindrical bore
 Shaft dia.:
 65~90mm

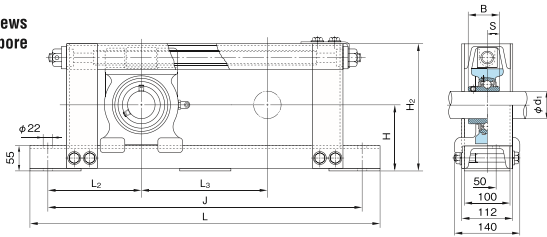

1N=0.102kgf

Shaft dia. d ₁ (mm)	Unit No.	Boundary dimensions (mm)									Bolt size	Bearings			Housing No.	Frame No.	Mass of Unit (kg)
		H	H ₂	L	J	L ₂	L ₃	B	S	No.		Basic load rating (N)					
												Cr	Cor				
65	UCTU313+WU500	145	285	940	880	190	500	75	30	M18	UC313	92500	59700	TU313	WU313-500	38.3	
	1040			980	600		WU313-600								40.6		
	1140			1080	700		WU313-700								42.9		
	1240			1180	800		WU313-800								45.3		
	1340			1280	900		WU313-900								47.6		
70	UCTU314+WU500	150	295	960	900	200	500	78	33	M18	UC314	104000	68000	TU314	WU314-500	40.8	
	1060			1000	600		WU314-600								43.1		
	1160			1100	700		WU314-700								45.4		
	1260			1200	800		WU314-800								47.8		
	1360			1300	900		WU314-900								50.1		
75	UCTU315+WU500	155	305	980	920	210	500	82	32	M18	UC315	114000	76900	TU315	WU315-500	43.6	
	1080			1020	600		WU315-600								45.9		
	1180			1120	700		WU315-700								48.3		
	1280			1220	800		WU315-800								50.6		
	1380			1320	900		WU315-900								52.9		
80	UCTU316+WU500	160	315	1000	940	220	500	86	34	M18	UC316	123000	86400	TU316	WU316-500	45.1	
	1100			1040	600		WU316-600								47.4		
	1200			1140	700		WU316-700								49.7		
	1300			1240	800		WU316-800								52.0		
	1400			1340	900		WU316-900								54.4		
85	UCTU317+WU500	165	325	1020	960	230	500	96	40	M18	UC317	132000	96500	TU317	WU317-500	49.8	
	1120			1060	600		WU317-600								52.1		
	1220			1160	700		WU317-700								54.4		
	1320			1260	800		WU317-800								56.7		
	1420			1360	900		WU317-900								59.0		
90	UCTU318+WU500	170	335	1050	990	245	500	96	40	M18	UC318	143000	107200	TU318	WU318-500	53.1	
	1150			1090	600		WU318-600								55.4		
	1250			1190	700		WU318-700								57.7		
	1350			1290	800		WU318-800								60.1		
	1450			1390	900		WU318-900								62.4		

Remarks: 1. Please contact NACHI for unit numbers appearing in italic.
 2. Grease nipple: PF1/8

Cylindrical Cartridge Units

UCC type
With set screws
Cylindrical bore
Shaft dia.: 12~140mm

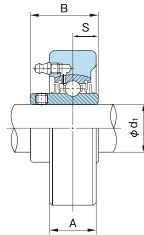
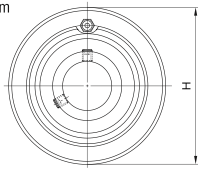

1N=0.102kgf

Shaft dia. d ₁ (mm)	Unit No.	Boundary dimensions (mm)				Bearings			Housing No.	Mass of Unit (kg)
		H	A	B	S	No.	Basic load rating (N)			
12	UCC201	72	20	31	12.7	UC201	12800	6600	C204	0.54
15	UCC202	72	20	31	12.7	UC202	12800	6600	C204	0.52
17	UCC203	72	20	31	12.7	UC203	12800	6600	C204	0.51
20	UCC204	72	20	31	12.7	UC204	12800	6600	C204	0.49
25	UCC205	80	22	34	14.3	UC205	14000	7900	C205	0.65
	UCCX05	90	27	38.1	15.9	UCX05	19600	11300	CX05	1.0
	UCC305	90	26	38	15	UC305	21300	10900	C305	1.1
30	UCC206	85	27	38.1	15.9	UC206	19600	11300	C206	0.82
	UCCX06	100	30	42.9	17.5	UCX06	25900	15400	CX06	1.3
	UCC306	100	28	43	17	UC306	26800	15000	C306	1.3
35	UCC207	90	28	42.9	17.5	UC207	25900	15400	C207	0.93
	UCCX07	110	34	49.2	19	UCX07	29300	17900	CX07	1.9
	UCC307	110	32	48	19	UC307	33500	19200	C307	1.8
40	UCC208	100	30	49.2	19	UC208	29300	17900	C208	1.2
	UCCX08	120	38	49.2	19	UCX08	33000	20500	CX08	2.3
	UCC308	120	34	52	19	UC308	40500	23900	C308	2.2
45	UCC209	110	31	49.2	19	UC209	33000	20500	C209	1.5
	UCCX09	120	38	51.6	19	UCX09	35500	23200	CX09	2.3
	UCC309	130	38	57	22	UC309	51500	29500	C309	2.7
50	UCC210	120	33	51.6	19	UC210	35500	23200	C210	1.9
	UCCX10	130	40	55.6	22.2	UCX10	43000	29400	CX10	2.8
	UCC310	140	40	61	22	UC310	61500	38200	C310	3.3
55	UCC211	125	35	55.6	22.2	UC211	43000	29400	C211	2.1
	UCCX11	150	42	65.1	25.4	UCX11	52500	36100	CX11	4.7
	UCC311	150	44	66	25	UC311	71500	44800	C311	3.9
60	UCC212	130	38	65.1	25.4	UC212	52500	36100	C212	2.5
	UCCX12	160	44	65.1	25.4	UCX12	57500	40000	CX12	5.1
	UCC312	160	46	71	26	UC312	81500	52000	C312	4.8
65	UCC213	140	40	65.1	25.4	UC213	57500	40000	C213	3.0
	UCC313	170	50	75	30	UC313	92500	59700	C313	5.7
70	UCC314	180	52	78	33	UC314	104000	68000	C314	6.6
75	UCC315	190	55	82	32	UC315	114000	76900	C315	7.7
80	UCC316	200	60	86	34	UC316	123000	86400	C316	8.9
85	UCC317	215	64	96	40	UC317	132000	96500	C317	11.2
90	UCC318	225	66	96	40	UC318	143000	107200	C318	12.3
95	UCC319	240	72	103	41	UC319	153000	118400	C319	15.2

1N=0.102kgf

Shaft dia. d ₁ (mm)	Unit No.	Boundary dimensions (mm)				Bearings			Housing No.	Mass of Unit (kg)
		H	A	B	S	No.	Basic load rating (N)			
100	UCC320	260	75	108	42	UC320	173000	140400	C320	19.2
105	UCC321	260	75	112	44	UC321	183000	153100	C321	18.9
110	UCC322	300	80	117	46	UC322	205000	178800	C322	28.1
120	UCC324	320	90	126	51	UC324	207000	184800	C324	35.0
130	UCC326	340	100	135	54	UC326	229000	214300	C326	42.2
140	UCC328	360	100	145	59	UC328	255000	246000	C328	48.9

Remark: Grease nipple: 1/4-28UNF for bore number 13 and under
PF1/8 for bore number 14 and over

Cylindrical Cartridge Units
UKC+H type
 With adapter assembly
 Tapered bore
 Shaft dia.: 20~125mm

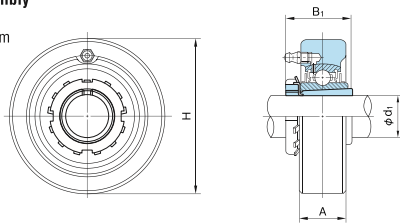

1N=0.102kgf

Shaft dia. d ₁ (mm)	Unit No.	Boundary dimensions (mm)			Bearings			Housing No.	Mass of Unit (kg)
		H	A	B ₁	No.	Basic load rating (N)			
						Cr	Cor		
20	UKC205+H2305	80	22	35	UK205+H2305	14000	7900	C205	0.70
	UKCX05+H2305	90	27	35	UKX05+H2305	19600	11300	CX05	1.0
	UKC305+H2305	90	26	35	UK305+H2305	21300	10900	C305	1.1
25	UKC206+H2306	85	27	38	UK206+H2306	19600	11300	C206	0.90
	UKCX06+H2306	100	30	38	UKX06+H2306	25900	15400	CX06	1.4
	UKC306+H2306	100	28	38	UK306+H2306	26800	15000	C306	1.4
30	UKC207+H2307	90	28	43	UK207+H2307	25900	15400	C207	0.99
	UKCX07+H2307	110	34	43	UKX07+H2307	29300	17900	CX07	1.8
	UKC307+H2307	110	32	43	UK307+H2307	33500	19200	C307	1.8
35	UKC208+H2308	100	30	46	UK208+H2308	29300	17900	C208	1.3
	UKCX08+H2308	120	38	46	UKX08+H2308	33000	20500	CX08	2.3
	UKC308+H2308	120	34	46	UK308+H2308	40500	23900	C308	2.2
40	UKC209+H2309	110	31	50	UK209+H2309	33000	20500	C209	1.7
	UKCX09+H2309	120	38	50	UKX09+H2309	35500	23200	CX09	2.3
	UKC309+H2309	130	38	50	UK309+H2309	51500	29500	C309	2.7
45	UKC210+H2310	120	33	55	UK210+H2310	35500	23200	C210	2.1
	UKCX10+H2310	130	40	55	UKX10+H2310	43000	29400	CX10	2.8
	UKC310+H2310	140	40	55	UK310+H2310	61500	38200	C310	3.3
50	UKC211+H2311	125	35	59	UK211+H2311	43000	29400	C211	2.3
	UKCX11+H2311	150	42	59	UKX11+H2311	52500	36100	CX11	4.6
	UKC311+H2311	150	44	59	UK311+H2311	71500	44800	C311	3.9
55	UKC212+H2312	130	38	62	UK212+H2312	52500	36100	C212	2.6
	UKCX12+H2312	160	44	62	UKX12+H2312	57500	40000	CX12	5.1
	UKC312+H2312	160	46	62	UK312+H2312	81500	52000	C312	4.7
60	UKC213+H2313	140	40	65	UK213+H2313	57500	40000	C213	3.1
	UKC313+H2313	170	50	65	UK313+H2313	92500	59700	C313	5.6
65	UKC315+H2315	190	55	73	UK315+H2315	114000	76900	C315	7.8
70	UKC316+H2316	200	60	78	UK316+H2316	123000	86400	C316	9.1
75	UKC317+H2317	215	64	82	UK317+H2317	132000	96500	C317	11.2
80	UKC318+H2318	225	66	86	UK318+H2318	143000	107200	C318	12.5
85	UKC319+H2319	240	72	90	UK319+H2319	153000	118400	C319	15.2
90	UKC320+H2320	260	75	97	UK320+H2320	173000	140400	C320	19.2

1N=0.102kgf

Shaft dia. d ₁ (mm)	Unit No.	Boundary dimensions (mm)			Bearings			Housing No.	Mass of Unit (kg)
		H	A	B ₁	No.	Basic load rating (N)			
						Cr	Cor		
100	UKC322+H2322	300	80	105	UK322+H2322	205000	178800	C322	28.2
110	UKC324+H2324	320	90	112	UK324+H2324	207000	184800	C324	34.5
115	UKC326+H2326	340	100	121	UK326+H2326	229000	214300	C326	42.5
125	UKC328+H2328	360	100	131	UK328+H2328	255000	246000	C328	49.2

Remark: Grease nipple: 1/4-28UNF for bore number 13 and under
 PF1/8 for bore number 14 and over

Hanger Units
UCECH type
With set screws
Cylindrical bore
 Shaft dia.: 12~60mm

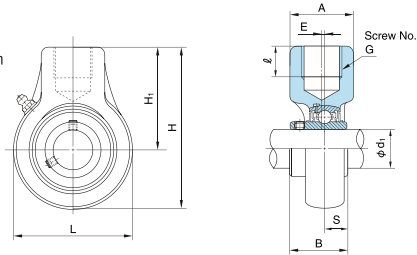

Shaft dia. d ₁ (mm)	Unit No.	Boundary dimensions (mm)										Bearings			Housing No.	Mass of Unit (kg)
		H	L	H ₁	A	G	ℓ	B	S	E	No.	Basic load rating (N)				
												Cr	Cor			
12	UCECH201	96	64	64	40	PF3/4	19	31	12.7	0	UC201	12800	6600	ECH204	0.85	
15	UCECH202	96	64	64	40	PF3/4	19	31	12.7	0	UC202	12800	6600	ECH204	0.83	
17	UCECH203	96	64	64	40	PF3/4	19	31	12.7	0	UC203	12800	6600	ECH204	0.82	
20	UCECH204	96	64	64	40	PF3/4	19	31	12.7	0	UC204	12800	6600	ECH204	0.80	
25	UCECH205	99	70	64	40	PF3/4	19	34	14.3	0	UC205	14000	7900	ECH205	0.74	
30	UCECH206	104	80	64	40	PF3/4	19	38.1	15.9	0	UC206	19600	11300	ECH206	0.91	
35	UCECH207	116	92	70	40	PF3/4	19	42.9	17.5	0	UC207	25900	15400	ECH207	1.2	
40	UCECH208	121	96	73	40	PF3/4	19	49.2	19	2	UC208	29300	17900	ECH208	1.4	
45	UCECH209	136	108	82	48	PF1	21	49.2	19	4	UC209	33000	20500	ECH209	1.8	
50	UCECH210	140	114	83	48	PF1	21	51.6	19	5	UC210	35500	23200	ECH210	1.9	
55	UCECH211	160	126	97	60	PF1 1/4	28	55.6	22.2	6	UC211	43000	29400	ECH211	2.3	
60	UCECH212	173	142	102	60	PF1 1/4	28	65.1	25.4	9	UC212	52500	36100	ECH212	4.2	

1N=0.102kgf

Remark: Grease nipple: 1/4-28UNF

Ball Bearings for Units

UC type
With set screws
Cylindrical bore
Shaft dia.: 12~140mm

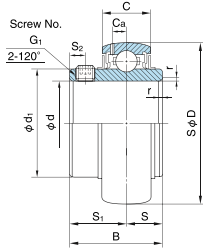

1N=0.102kgf

Shaft dia. (mm)	Ball Bearing No.	Boundary dimensions (mm)													Basic load rating (N)		Mass (kg)
		d	D	B	C	r	S	S ₁	S ₂	G ₁	Ca	d ₁	Cr	Cor			
12	UC201	12	47	31	17	1	12.7	18.3	4.5	M 6×0.75	4.5	29	12800	6600	0.21		
15	UC202	15	47	31	17	1	12.7	18.3	4.5	M 6×0.75	4.5	29	12800	6600	0.19		
17	UC203	17	47	31	17	1	12.7	18.3	4.5	M 6×0.75	4.5	29	12800	6600	0.18		
20	UC204	20	47	31	17	1.5	12.7	18.3	4.5	M 6×0.75	4.5	29	12800	6600	0.16		
25	UC205	25	52	34	17	1.5	14.3	19.7	5	M 6×0.75	4.5	34	14000	7900	0.19		
	UCX05	25	62	38.1	19	1.5	15.9	22.2	5	M 6×0.75	5.1	40.5	19600	11300	0.37		
	UC305	25	62	38	21	2	15	23	6	M 6×0.75	6.1	36.9	21300	10900	0.44		
30	UC206	30	62	38.1	19	1.5	15.9	22.2	5	M 6×0.75	5.1	40.5	19600	11300	0.31		
	UCX06	30	72	42.9	20	1.5	17.5	25.4	6	M 8×1	5.8	48	25900	15400	0.46		
	UC306	30	72	43	23	2	17	26	6	M 6×0.75	6.7	45	26800	15000	0.56		
35	UC207	35	72	42.9	20	2	17.5	25.4	6	M 8×1	5.8	48	25900	15400	0.48		
	UCX07	35	80	49.2	21	2	19	30.2	8	M 8×1	6.2	53	29300	17900	0.74		
	UC307	35	80	48	25	2.5	19	29	8	M 8×1	7.4	50.5	33500	19200	0.71		
40	UC208	40	80	49.2	21	2	19	30.2	8	M 8×1	6.2	53	29300	17900	0.62		
	UCX08	40	85	49.2	22	2	19	30.2	8	M 8×1	6.5	57.3	33000	20500	0.80		
	UC308	40	90	52	27	2.5	19	33	10	M10×1.25	8.2	56	40500	23900	1.00		
45	UC209	45	85	49.2	22	2	19	30.2	8	M 8×1	6.5	57.3	33000	20500	0.67		
	UCX09	45	90	51.6	23	2	19	32.6	9	M10×1.25	6.5	63	35500	23200	0.92		
	UC309	45	100	57	30	2.5	22	35	10	M10×1.25	9	63	51500	29500	1.28		
50	UC210	50	90	51.6	23	2	19	32.6	9	M10×1.25	6.5	63	35500	23200	0.78		
	UCX10	50	100	55.6	24	2	22.2	33.4	9	M10×1.25	7.3	70	43000	29400	1.21		
	UC310	50	110	61	32	3	22	39	12	M12×1.5	10	70.5	61500	38200	1.65		
55	UC211	55	100	55.6	24	2.5	22.2	33.4	9	M10×1.25	7.3	70	43000	29400	1.03		
	UCX11	55	110	65.1	26	2.5	25.4	39.7	10	M10×1.25	7.7	77	52500	36100	1.72		
	UC311	55	120	66	34	3	25	41	12	M12×1.5	10.7	76.5	71500	44800	2.07		
60	UC212	60	110	65.1	26	2.5	25.4	39.7	10	M10×1.25	7.7	77	52500	36100	1.45		
	UCX12	60	120	65.1	27	2.5	25.4	39.7	10	M10×1.25	8.3	82.1	57500	40000	1.97		
	UC312	60	130	71	36	3.5	26	45	12	M12×1.5	11.5	82.5	81500	52000	2.59		
65	UC213	65	120	65.1	27	2.5	25.4	39.7	10	M10×1.25	8.3	82.1	57500	40000	1.71		
	UCX13	65	125	74.6	29	2.5	30.2	44.4	12	M12×1.5	8.7	87	62000	44000	2.33		
	UC313	65	140	75	38	3.5	30	45	12	M12×1.5	12.2	88.5	92500	59700	3.15		
70	UC214	70	125	74.6	29	2.5	30.2	44.4	12	M12×1.5	8.7	87	62000	44000	2.06		
	UCX14	70	130	77.8	30	2.5	33.3	44.5	12	M12×1.5	9.2	91.5	66000	48200	2.57		
	UC314	70	150	78	40	3.5	33	45	12	M12×1.5	13	95.2	104000	68000	3.83		

1N=0.102kgf

Shaft dia. (mm)	Ball Bearing No.	Boundary dimensions (mm)													Basic load rating (N)		Mass (kg)
		d	D	B	C	r	S	S ₁	S ₂	G ₁	Ca	d ₁	Cr	Cor			
75	UC215	75	130	77.8	30	2.5	33.3	44.5	14	M12×1.5	9.2	91.5	66000	48200	2.22		
	UCX15	75	140	82.6	32	2.5	33.3	49.3	12	M12×1.5	9.6	98.5	72500	53000	3.22		
	UC315	75	160	82	42	3.5	32	50	14	M14×1.5	13.8	101.5	114000	76900	4.59		
80	UC216	80	140	82.6	32	3	33.3	49.3	14	M12×1.5	9.6	98.5	72500	53000	2.82		
	UCX16	80	150	85.7	34	3	34.1	51.6	12	M12×1.5	10.5	105	83500	61800	3.81		
	UC316	80	170	86	44	3.5	34	52	14	M14×1.5	14.5	108	123000	86400	5.40		
85	UC217	85	150	85.7	34	3	34.1	51.6	14	M12×1.5	10.5	105	83500	61800	3.38		
	UCX17	85	160	96	36	3	39.7	56.3	12	M12×1.5	11.1	111.5	95500	71400	4.83		
	UC317	85	180	96	46	4	40	56	16	M16×1.5	15	114.5	132000	96500	6.58		
90	UC218	90	160	96	36	3	39.7	56.3	15	M12×1.5	11.1	111.5	95500	71400	4.34		
	UCX18	90	170	104	38	3	42.9	61.1	14	M14×1.5	11.9	118	109000	81600	5.49		
	UC318	90	190	96	48	4	40	56	16	M16×1.5	15.9	121	143000	107200	7.34		
95	UC319	95	200	103	50	4	41	62	16	M16×1.5	16.7	127.5	153000	118400	8.70		
100	UCX20	100	190	117.5	42	3.5	49.2	68.3	16	M16×1.5	13	132.5	134000	104700	9.04		
	UC320	100	215	108	54	4	42	66	18	M18×1.5	18	135.5	173000	140400	10.8		
105	UC321	105	225	112	56	4	44	68	18	M18×1.5	19	142	183000	153100	12.2		
110	UC322	110	240	117	60	4	46	71	18	M18×1.5	21	152	205000	178800	14.3		
120	UC324	120	260	126	64	4	51	75	18	M18×1.5	22	165	207000	184800	18.5		
130	UC326	130	280	135	68	5	54	81	20	M20×1.5	23	178	229000	214300	23.0		
140	UC328	140	300	145	73	5	59	86	20	M20×1.5	25	191.5	255000	246000	28.5		

Remark: Chamfer dimensions "*" shown in the table are nominal dimension.

Ball Bearings for Units
UK+H type
 With adapter assembly
 Tapered bore
 Shaft dia.: 20~125mm

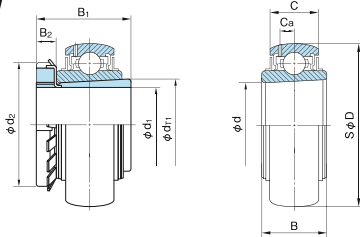

1N=0.102kgf

Shaft dia. (mm)	Ball Bearing No.	Boundary dimensions (mm)											Basic load rating (N)		Mass (kg)
		d1	D	B1	d	B	C	Ca	B2	d2	d1r	Cr	Cor		
20	UK205+H2305	20	52	35	25	23	17	4.5	8	38	27.5	14000	7900	0.24	
	UKX05+H2305	20	62	35	25	26	19	5.1	8	38	27.5	19600	11300	0.37	
	UK305+H2305	20	62	35	25	26	21	6.1	8	38	27.5	21300	10900	0.48	
25	UK206+H2306	25	62	38	30	26	19	5.1	8	45	32.5	19600	11300	0.40	
	UKX06+H2306	25	72	38	30	27	20	5.8	8	45	32.5	25900	15400	0.54	
	UK306+H2306	25	72	38	30	29	23	6.7	8	45	32.5	26800	15000	0.59	
30	UK207+H2307	30	72	43	35	27	20	5.8	9	52	38	25900	15400	0.53	
	UKX07+H2307	30	80	43	35	29	21	6.2	9	52	38	29300	17900	0.70	
	UK307+H2307	30	80	43	35	31	25	7.4	9	52	38	33500	19200	0.74	
35	UK208+H2308	35	80	46	40	29	21	6.2	10	58	43	29300	17900	0.69	
	UKX08+H2308	35	85	46	40	30	22	6.5	10	58	43	33000	20500	0.81	
	UK308+H2308	35	90	46	40	34	27	8.2	10	58	43	40500	23900	1.01	
40	UK209+H2309	40	85	50	45	30	22	6.5	11	65	48.5	33000	20500	0.77	
	UKX09+H2309	40	90	50	45	31	23	6.5	11	65	48.5	35500	23200	0.94	
	UK309+H2309	40	100	50	45	37	30	9	11	65	48.5	51500	29500	1.31	
45	UK210+H2310	45	90	55	50	31	23	6.5	12	70	54	35500	23200	0.93	
	UKX10+H2310	45	100	55	50	33	24	7.3	12	70	54	43000	29400	1.22	
	UK310+H2310	45	110	55	50	40	32	10	12	70	54	61500	38200	1.68	
50	UK211+H2311	50	100	59	55	33	24	7.3	12	75	59	43000	29400	1.16	
	UKX11+H2311	50	110	59	55	36	26	7.7	12	75	59	52500	36100	1.54	
	UK311+H2311	50	120	59	55	43	34	10.7	12	75	59	71500	44800	2.06	
55	UK212+H2312	55	110	62	60	36	26	7.7	13	80	64.5	52500	36100	1.47	
	UKX12+H2312	55	120	62	60	38	27	8.3	13	80	64.5	57500	40000	1.89	
	UK312+H2312	55	130	62	60	46	36	11.5	13	80	64.5	81500	52000	2.53	
60	UK213+H2313	60	120	65	65	38	27	8.3	14	85	69.5	57500	40000	1.82	
	UKX13+H2313	60	125	65	65	40	29	8.7	14	85	69.5	62000	44000	2.09	
	UK313+H2313	60	140	65	65	48	38	12.2	14	85	69.5	92500	59700	3.07	
65	UK215+H2315	65	130	73	75	41	30	9.2	15	98	80	66000	48200	2.59	
	UKX15+H2315	65	140	73	75	44	32	9.6	15	98	80	72500	53000	3.25	
	UK315+H2315	65	160	73	75	54	42	13.8	15	98	80	114000	76900	4.74	
70	UK216+H2316	70	140	78	80	44	32	9.6	17	105	85.5	72500	53000	3.27	
	UKX16+H2316	70	150	78	80	46	34	10.5	17	105	85.5	83500	61800	3.86	
	UK316+H2316	70	170	78	80	57	44	14.5	17	105	85.5	123000	86400	5.62	
75	UK217+H2317	75	150	82	85	46	34	10.5	18	110	90.5	83500	61800	3.92	
	UKX17+H2317	75	160	82	85	49	36	11.1	18	110	90.5	95500	71400	4.72	
	UK317+H2317	75	180	82	85	60	46	15	18	110	90.5	132000	96500	6.56	

1N=0.102kgf

Shaft dia. (mm)	Ball Bearing No.	Boundary dimensions (mm)											Basic load rating (N)		Mass (kg)
		d1	D	B1	d	B	C	Ca	B2	d2	d1r	Cr	Cor		
80	UK218+H2318	80	160	86	90	49	36	11.1	18	120	96	95500	71400	4.68	
	UKX18+H2318	80	170	86	90	52	38	11.9	18	120	96	109000	81600	5.11	
	UK318+H2318	80	190	86	90	63	48	15.9	18	120	96	143000	107200	7.52	
85	UK319+H2319	85	200	90	95	66	50	16.7	19	125	101	153000	118400	8.72	
	UKX20+H2320	90	190	97	100	58	42	13	20	130	106.5	134000	104700	8.10	
90	UK320+H2320	90	215	97	100	72	54	18	20	130	106.5	173000	140400	10.8	
	UK322+H2322	100	240	105	110	80	60	21	21	145	117	205000	178800	14.4	
100	UK324+H2324	110	260	112	120	86	64	22	22	155	127.5	207000	184800	18.0	
115	UK326+H2326	115	280	121	130	92	68	23	23	165	138.5	229000	214300	23.3	
125	UK328+H2328	125	300	131	140	98	73	25	24	180	149	255000	246000	28.8	

Ball Bearings for Units

B type
 With set screws
 Cylindrical bore
 Shaft dia.: 12~35mm

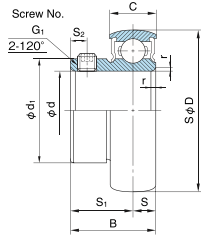

B type

Shaft dia. (mm)	Ball Bearing No.	Boundary dimensions (mm)										Basic load rating (N)		Mass (kg)
		d	D	B	C	r	S	S ₁	S ₂	G ₁	d ₁	Cr	Cor	
12	B1	12	40	22	12	1	6	16	4	M5×0.8	24.7	9550	4800	0.10
15	B2	15	40	22	12	1	6	16	4	M5×0.8	24.7	9550	4800	0.09
17	B3	17	40	22	12	1	6	16	4	M5×0.8	24.7	9550	4800	0.07
20	B4	20	47	24.7	14	1.5	7	17.7	4.5	M5×0.8	29	12800	6600	0.12
25	B5	25	52	27	15	1.5	7.5	19.5	5	M6×0.75	34	14000	7900	0.16
30	B6	30	62	30.3	16	1.5	8	22.3	5	M6×0.75	40.5	19600	11300	0.25
35	B7	35	72	32.9	17	2	8.5	24.4	6	M8×1	48	25900	15400	0.38

Remark: Chamfer dimensions "r" shown in the table are nominal dimension.

KHAE type
 With eccentric collar
 Cylindrical bore
 Shaft dia.: 12~35mm

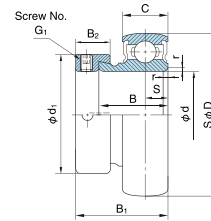

1N=0.102kgf

KHAE type

Shaft dia. (mm)	Ball Bearing No.	Boundary dimensions (mm)										Basic load rating (N)		Mass (kg)
		d	D	B ₁	B	C	r	S	d ₁	B ₂	G	Cr	Cor	
12	KH201AE	12	40	28.6	19.1	12	1	6.5	28.6	13.5	M 6×0.75	9550	4800	0.12
15	KH202AE	15	40	28.6	19.1	12	1	6.5	28.6	13.5	M 6×0.75	9550	4800	0.11
17	KH203AE	17	40	28.6	19.1	12	1	6.5	28.6	13.5	M 6×0.75	9550	4800	0.10
20	KH204AE	20	47	31	21.5	14	1.5	7.5	33.3	13.5	M 6×0.75	12800	6600	0.16
25	KH205AE	25	52	31	21.5	15	1.5	7.5	38.1	13.5	M 6×0.75	14000	7900	0.20
30	KH206AE	30	62	35.7	23.8	16	1.5	9	44.5	15.9	M 8×1	19600	11300	0.31
35	KH207AE	35	72	38.9	25.4	17	2	9.5	55.6	17.5	M10×1.25	25900	15400	0.49

Remark: Chamfer dimensions "r" shown in the table are nominal dimension.

Silver series

Ball Bearings for Units

With eccentric collar

Cylindrical bore

U+ER type

Shaft dia.: 8~30mm

MU+ER type (Stainless Silver Series)

Shaft dia.: 10~30mm

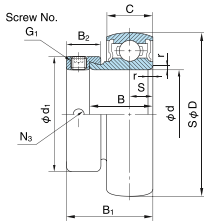

U+ER type

1N=0.102kgf

Shaft dia. (mm)	Ball Bearing No.	Boundary dimensions (mm)											Basic load rating (N)		Mass (kg)
		d	D	B ₁	B	C	r	S	d ₁	B ₂	G ₁	N ₃	Cr	Cor	
10	U000+ER	10	26	17.5	11	8	0.5	4	17	8.5	M4×0.7	3.5	4600	2000	30
12	U001+ER	12	28	17.5	11	8	0.5	4	19	8.5	M4×0.7	3.5	5100	2400	36
15	U002+ER	15	32	18.5	12	9	0.5	4.5	22	8.5	M4×0.7	3.5	5600	2800	50
17	U003+ER	17	35	20.5	13.5	10	0.5	5	25	9.5	M4×0.7	3.5	6000	3300	62
20	U004+ER	20	42	24.5	16.5	12	1	6	30	11	M5×0.8	5	9350	5100	104
25	U005+ER	25	47	25.5	17.5	12	1	6	36	12	M5×0.8	5	10100	5800	133
30	U006+ER	30	55	26.5	18.5	13	1.5	6.5	42	12	M5×0.8	5	13200	8300	186
8	U 08+ER(*)	8	22	15	10	7	0.3	3.5	14	7	M3×0.5	2.5	3300	1360	16

Note: (*) U08X with set screws is available. U08X: B=12, d₁=11.3, set screw 2-M3×0.5 S2=2.5 (side surface to set screw center)
Remark: Chamfer dimensions "r" shown in the table are nominal dimension.

MU+ER type (Stainless Silver Series)

1N=0.102kgf

Shaft dia. (mm)	Ball Bearing No.	Boundary dimensions (mm)											Basic load rating (N)		Mass (kg)
		d	D	B ₁	B	C	r	S	d ₁	B ₂	G ₁	N ₃	Cr	Cor	
10	MU000+ER	10	26	17.5	11	8	0.5	4	17	8.5	M4×0.7	3.5	3900	1550	30
12	MU001+ER	12	28	17.5	11	8	0.5	4	19	8.5	M4×0.7	3.5	4300	1900	36
15	MU002+ER	15	32	18.5	12	9	0.5	4.5	22	8.5	M4×0.7	3.5	4750	2250	50
17	MU003+ER	17	35	20.5	13.5	10	0.5	5	25	9.5	M4×0.7	3.5	5100	2650	62
20	MU004+ER	20	42	24.5	16.5	12	1	6	30	11	M5×0.8	5	7900	4000	104
25	MU005+ER	25	47	25.5	17.5	12	1	6	36	12	M5×0.8	5	8600	4650	133
30	MU006+ER	30	55	26.5	18.5	13	1.5	6.5	42	12	M5×0.8	5	11300	6600	186

Remark: Chamfer dimensions "r" shown in the table are nominal dimension.

Ball Bearings for Units
UG+ER type
With eccentric collar
Cylindrical bore
 Shaft dia.: 20~60mm

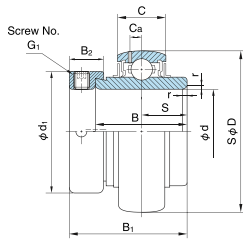

Shaft dia. (mm)	Ball Bearing No.	Boundary dimensions (mm)										Basic load rating (N)		Mass (kg)
		d	D	B ₁	B	C	r	S	d ₁	B ₂	G ₁	C _r	C _{or}	
20	UG204+ER	20	47	43.7	34.2	17	1.5	17.1	33.3	13.5	M 6×0.75	12800	6600	0.21
25	UG205+ER	25	52	44.4	34.9	17	1.5	17.5	38.1	13.5	M 6×0.75	14000	7900	0.23
30	UG206+ER	30	62	48.4	36.5	19	1.5	18.3	44.5	15.9	M 8×1	19600	11300	0.37
35	UG207+ER	35	72	51.1	37.6	20	2	18.8	55.6	17.5	M10×1.25	25900	15400	0.60
40	UG208+ER	40	80	56.3	42.8	21	2	21.4	60.3	18.3	M10×1.25	29300	17900	0.76
45	UG209+ER	45	85	56.3	42.8	22	2	21.4	63.5	18.3	M10×1.25	33000	20500	0.79
50	UG210+ER	50	90	62.7	49.2	23	2	24.6	69.9	18.3	M10×1.25	35500	23200	0.91
55	UG211+ER	55	100	71.4	55.5	24	2.5	27.8	76.2	20.7	M12×1.5	43000	29400	1.26
60	UG212+ER	60	110	77.8	61.9	26	2.5	31	84.2	22.3	M12×1.5	52500	36100	1.70

1N=0.102kgf

Remark: Chamfer dimensions "r" shown in the table are nominal dimension.

Ball Bearings for Units
 With stainless
MUC type
 With set screws
 Cylindrical bore
 Shaft dia.: 20~50mm

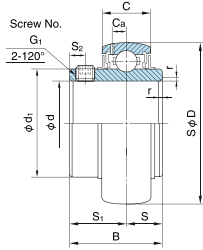

Shaft dia. (mm)	Ball Bearing No.	Boundary dimensions (mm)											Basic load rating (N)		Mass (kg)
		d	D	B	C	r	S	S ₁	S ₂	G ₁	C _a	d ₁	C _r	C _{or}	
20	MUC204	20	47	31	17	1.5	12.7	18.3	4.5	M 6×1	4.5	29	10900	5300	0.16
25	MUC205	25	52	34	17	1.5	14.3	19.7	5	M 6×1	4.5	34	11900	6300	0.19
30	MUC206	30	62	38.1	19	1.5	15.9	22.2	5	M 6×1	5.1	40.5	16700	9050	0.31
35	MUC207	35	72	42.9	20	2	17.5	25.4	6	M 8×1	5.8	48	22000	12300	0.48
40	MUC208	40	80	49.2	21	2	19	30.2	8	M 8×1	6.2	53	24900	14300	0.62
45	MUC209	45	85	49.2	22	2	19	30.2	8	M 8×1	6.5	57.3	28100	16400	0.67
50	MUC210	50	90	51.6	23	2	19	32.6	9	M10×1.25	6.5	63	30200	18600	0.78

1N=0.102kgf

Remark: Chamfer dimensions "r" shown in the table are nominal dimension.



Plummer Block Housings

Plummer Block housings ease to constitute bearing units by using with self-aligning ball bearings or spherical roller bearings.
NACHI Plummer Block housing design is improved in term of accuracy, strength and rigidity.

● Features

- Wide range of sizes and configurations allows selection of optimal housing.
- Low weight to strength ratio.

- For straight shaft, the bearings with tapered bore and adapter can be mounted at any selected shaft position.
- For stepped-shaft, the bearings with cylindrical bore are fixed by shaft nut.

Remark: Housings not listed in the dimensions tables are also manufactured, consult NACHI for more information.

Table of contents

Type	Symbol	Bore diameter on both sides	Applicable Bearing	Shaft Dia. (mm)	Page
Split type	SN Standard type	SN5	Same	Tapered bore with adapter	20~140
		SN6			20~140
		SN30			10~170
		SN31			00~170
	SN Flat bottom type	SN5F	Same	Tapered bore with adapter	20~140
		SN6F			20~140
	SN Large bore dia on both sides	SN2	Same	Cylindrical bore	25~160
		SN3			25~85
		SN2C	Difference	Cylindrical bore	25~160
		SN3C			25~85
	SN Large bore dia on both sides Flat bottom	SN2F	Same	Cylindrical bore	25~160
		SN3F			25~85
SN2FC		Difference	Cylindrical bore	25~160	
SN3FC				25~85	
SD Standard type	SD5	Same	Tapered bore with adapter	150~300	
	SD6			150~260	
	SD30			150~300	
	SD31			150~300	
One-piece type	V Standard type	V	Same	Tapered bore with adapter	30~200
		Difference			Difference

Remark: Please contact NACHI for housings not listed in table, special dimension, and with special accessories.

1. Materials for Plummer Block Housings

NACHI Plummer Blocks are made of gray cast iron FC200.

Spheroidal graphite iron castings FCD450 or carbon steel castings SC450 can be used for severe conditions such as vibration, shock and heavy load.

Materials for accessories are shown in right table.

Materials for Accessories

Accessory	Material	Symbol
Bolt	Rolled steels for general structure	SS400
Spring lock washer	High carbon steel wire rods	SWRH62B
Cover of V series	Gray iron castings	FC200
Oil seal	Nitrile rubber	NBR
Drainage plug	Carbon steels for machine structure use	S10C
Eyebolt	Rolled steels for general structure	SS400
Grease nipple	Free-cutting brass	C3604B
Locating ring	Gray iron castings	FC200
Adapter sleeve, Locknut, Lockplate	Carbon steels for machine structure use or Rolled steels for general structure	S25C or SS400
Plain washer	Rolled steels for general structure	SS400

2. Designations

(1) Designations of Plummer Block Housings

Designations of Plummer Block Housings are shown as follows.

• Split-housings

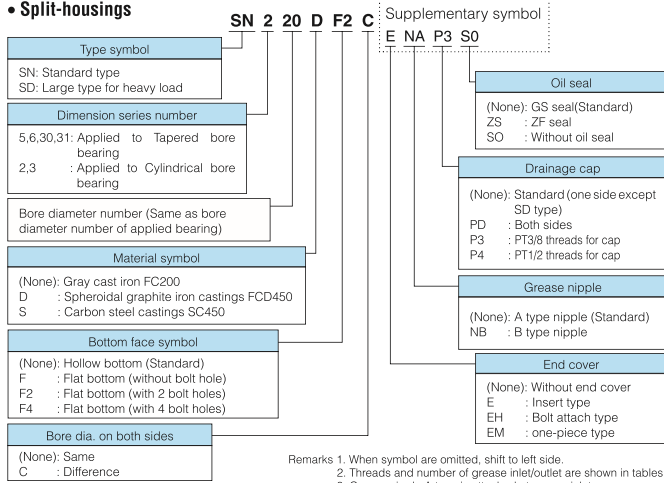

• One-piece housings

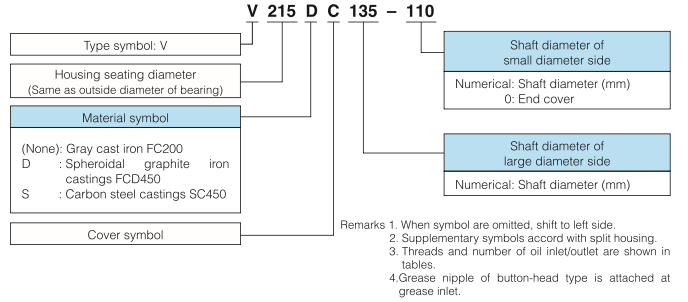

(2) Locating Rings

Locating ring for fixed side housing is identified as follows. locating ring should be prepared besides plummer block housings.

The dimension table show the designation and number of ring required for each bearing.

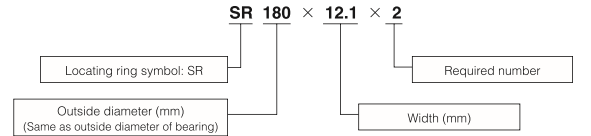

(3) Combination of Plummer Block Housing, Bearing, Adapter and Locating Ring

The designations of combination are obtained by adding each with '+' as following order.

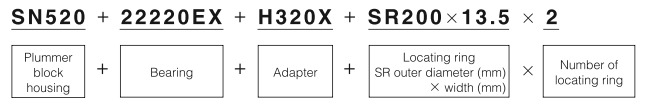

3. Tolerances for Plummer Block Housings

The tolerances of housing seating bore, width and height from mounting face to centerline of housing seating bore are shown in dimension tables. The bore diameter and tolerance of the openings at both sides of housings are shown in right table.

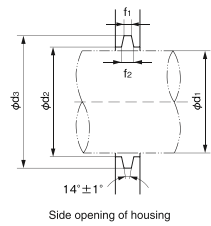

Dimensions and Tolerances of Side Openings Unit: mm

Shaft Dia d1	d2		ds		f1		f2	Oil seal (Ref.)
	Nominal	Tolerance (H12)	Nominal	Tolerance (H12)	Nominal	Tolerance (H13)		
20	21.5	+0.210	31	0	3	+0.140	4.2	GS 5
25	26.5	0	38	0	4	0	5.4	GS 6
30	31.5	0	43	0	4	0	5.4	GS 7
35	36.5	+0.250	48	0	4	0	5.4	GS 8
40	41.5	0	53	0	4	0	5.4	GS 9
45	46.5	0	58	0	4	0	5.4	GS 10
50	51.5	0	67	0	5	0	6.9	GS 11
55	56	0	72	0	5	0	6.9	GS 12
60	62	+0.300	77	0	5	0	6.9	GS 13
65	67	0	82	0	5	0	6.8	GS 15
70	72	0	89	0	6	0	8.1	GS 16
75	77	0	94	0	6	0	8.1	GS 17
80	82	0	99	0	6	0	8.1	GS 18
85	87	0	104	0	6	0	8.1	GS 19
90	92	0	111	0	7	0	9.3	GS 20
95	97	+0.350	116	0	7	0	9.3	GS 21
100	102	0	125	0	8	0	10.8	GS 22
105	107	0	130	0	8	0	10.8	GS 23
110	113	0	135	0	8	0	10.7	GS 24
115	118	0	140	0	8	0	10.7	GS 26
120	123	0	145	0	8	0	10.7	GS 27
125	128	0	154	0	9	0	12.2	GS 28
130	133	0	159	0	9	0	12.2	GS 29
135	138	0	164	0	9	0	12.2	GS 30
140	143	0	173	0	10	+0.220	13.7	GS 32
145	148	+0.400	178	0	10	0	13.7	GS 33
150	153	0	183	0	10	0	13.7	GS 34
155	158	0	188	0	10	0	13.7	GS 35
160	163	0	193	0	10	0	13.7	GS 36
165	168	0	198	0	10	0	13.7	GS 37
170	173	0	203	+0.460	10	0	13.7	GS 38
175	178	0	208	0	10	0	13.7	GS 39
180	183	0	213	0	10	0	13.7	GS 40
190	193	0	223	0	10	0	13.7	GS 42
200	203	+0.460	240	0	11	0	15.5	GS 44
210	213	0	250	0	11	0	15.5	GS 46
220	223	0	260	0	11	0	15.5	GS 48
230	233	0	270	0	11	0	15.5	GS 50
240	243	0	286	+0.520	12	0	17.3	GS 52
250	253	0	296	0	12	0	17.3	GS 54
260	263	+0.520	306	0	12	0	17.3	GS 56
270	273	0	322	0	13	0	19	GS 58
280	283	0	332	0	13	+0.270	19	GS 60
300	303	0	352	0	13	0	19	GS 64
320	323	0	370	0	14	0	19.8	GS 68
340	343	+0.570	390	0	14	0	19.8	GS 72
360	363	0	412	0	13	0	19	GS 76
380	383	0	432	0	13	0	19	GS 80
400	403	0	452	+0.630	14	0	20	GS 84
410	413	+0.630	460	0	14	0	19.8	GS 88
430	433	0	480	0	14	0	19.8	GS 92
450	453	0	505	+0.700	14	0	20.3	GS 96

Remark: Number of oil seal is applicable to ZF seal with same number.

(Reference)

Bearing type	Self-aligning Ball Bearings				Spherical Roller Bearings					
	12	22	13	23	230	231	222	232	213	223
SN5 SN5F	05K ~22K	05K ~22K	—	—	—	—	05K ~32K	18K ~32K	—	—
SN6 SN6F	—	—	05K ~22K	05K ~22K	—	—	—	—	05K ~22K	08K ~32K
SN30	—	—	—	—	24K ~38K	—	—	—	—	—
SN31	—	—	—	—	—	22K ~38K	—	—	—	—
SN2 SN2F	05 ~22	05 ~22	—	—	—	—	05 ~32	18 ~32	—	—
SN3 SN3F	—	—	05 ~17	05 ~17	—	—	—	—	05 ~17	08 ~17
SD5	—	—	—	—	—	—	34K ~64K	—	—	—
SD6	—	—	—	—	—	—	—	—	—	34K ~56K
SD30	—	—	—	—	34K ~64K	—	—	—	—	—
SD31	—	—	—	—	—	34K ~64K	—	—	—	—
V	08(K) ~22(K)	08(K) ~22(K)	07(K) ~22(K)	07(K) ~22(K)	22(K) ~44(K)	22(K) ~40(K)	08(K) ~38(K)	22(K) ~38(K)	07(K) ~22(K)	08(K) ~32(K)

Plummer Block Housings
SN5, SN6, SN30, SN31 Series
for Bearing with Adapter Sleeve
 Shaft Diameter: 20~55mm

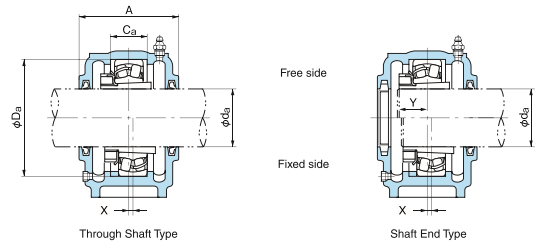
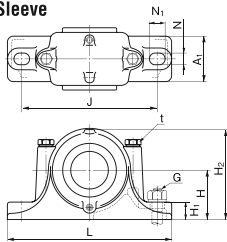

Shaft dia. da (mm)	Dimensions (mm)														Mass (kg) (Reference)	Designations		Applicable parts							Y (Reference)
	D _a (H8)	H (h13)	J	N	N ₁	A	L	A ₁	H ₁	H ₂	C _a (H13)	G (Nominal)	l (Nominal) (Reference)	Through Shaft Type		Shaft End Type	Self-aligning ball bearings	Spherical roller bearings	Adapter sleeve	Oil seal	Locating ring				
																						Designations	Q'ty		
20	52	40	130	15	20	67	165	46	22	75	25	M12	M 8	1.1	SN505	SN505E	1205K	—	H205X	GS 5	SR52 × 5	2	17		
															SN605	SN605E	2205K	22205EXK	H305X	GS 5	SR52 × 7	1	19		
	62	50	150	15	20	80	185	52	22	90	34	M12	M 8	1.6			1305K	21305EK	H305X	GS 5	SR62 × 8.5	2	18		
																	2305K	—	H2305X	GS 5	SR62 × 10	1	22		
25	62	50	150	15	20	77	185	52	22	90	30	M12	M 8	1.7	SN506	SN506E	1206K	—	H206X	GS 6	SR62 × 7	2	18		
																	2206K	22206EXK	H306X	GS 6	SR62 × 10	1	20		
	72	50	150	15	20	82	185	52	22	95	37	M12	M10	1.8	SN606	SN606E	1306K	21306EK	H306X	GS 6	SR72 × 9	2	19		
																	2306K	—	H2306X	GS 6	SR72 × 10	1	23		
30	72	50	150	15	20	82	185	52	22	95	33	M12	M10	1.9	SN507	SN507E	1207K	—	H207X	GS 7	SR72 × 8	2	19		
																	2207K	22207EXK	H307X	GS 7	SR72 × 10	1	22		
	80	60	170	15	20	90	205	60	25	110	41	M12	M10	2.6	SN607	SN607E	1307K	21307EK	H307X	GS 7	SR80 × 10	2	21		
																	2307K	—	H2307X	GS 7	SR80 × 10	1	26		
35	80	60	170	15	20	85	205	60	25	110	33	M12	M10	2.6	SN508	SN508E	1208K	—	H208X	GS 8	SR80 × 7.5	2	21		
																	2208K	22208EXK	H308X	GS 8	SR80 × 10	1	23		
	90	60	170	15	20	95	205	60	25	115	43	M12	M10	2.9	SN608	SN608E	1308K	21308EK	H308X	GS 8	SR90 × 10	2	23		
																	2308K	22308EXK	H2308X	GS 8	SR90 × 10	1	28		
40	85	60	170	15	20	85	205	60	25	112	31	M12	M10	2.8	SN509	SN509E	1209K	—	H209X	GS 9	SR85 × 6	2	22		
																	2209K	22209EXK	H309X	GS 9	SR85 × 8	1	24		
	100	70	210	18	23	105	255	70	28	130	46	M16	M12	4.1	SN609	SN609E	1309K	21309EK	H309X	GS 9	SR100 × 10.5	2	25		
																	2309K	22309EXK	H2309X	GS 9	SR100 × 10	1	31		
45	90	60	170	15	20	90	205	60	25	115	33	M12	M10	3.0	SN510	SN510E	1210K	—	H210X	GS10	SR90 × 6.5	2	24		
																	2210K	22210EXK	H310X	GS10	SR90 × 10	1	25		
	110	70	210	18	23	115	255	70	30	135	50	M16	M12	4.7	SN610	SN610E	1310K	21310EK	H310X	GS10	SR110 × 11.5	2	27		
																	2310K	22310EXK	H2310X	GS10	SR110 × 10	1	34		
50	100	70	210	18	23	95	255	70	28	130	33	M16	M12	4.5	SN511	SN511E	1211K	—	H211X	GS11	SR100 × 6	2	25		
																	2211K	22211EXK	H311X	GS11	SR100 × 8	1	27		
	120	80	230	18	23	120	275	80	30	150	53	M16	M12	5.8	SN611	SN611E	1311K	21311EK	H311X	GS11	SR120 × 12	2	29		
																	2311K	22311EXK	H2311X	GS11	SR120 × 10	1	36		
55	110	70	210	18	23	105	255	70	30	135	38	M16	M12	5.0	SN512	SN512E	1212K	—	H212X	GS12	SR110 × 8	2	26		
																	2212K	22212EXK	H312X	GS12	SR110 × 10	1	29		
	130	80	230	18	23	125	280	80	30	155	56	M16	M12	6.5	SN612	SN612E	1312K	21312EK	H312X	GS12	SR130 × 12.5	2	31		
																	2312K	22312EXK	H2312X	GS12	SR130 × 10	1	39		

Remarks: 1. Plummer block housings are housings with oil seals, a plug and a grease nipple only.
 To make a complete unit, please order the corresponding bearing, adapter sleeve and locating rings shown in the table additionally.
 2. The masses in the table do not include the bearing, adapter sleeve and locating rings but the bolts.
 3. H8, H13 and h13 in the table means tolerance classes specified in JIS B 0401.
 4. The tolerance of locating ring O.D. is h12, and 0 -0.2 for the width.

5. When one locating ring is used for fixed-end, the offset (X dimension) of bearing center from the center of the plummer block housing is a half of the locating ring width.
 6. The threads for plugs are PT1/8. SN505 does not have a drain hole.
 7. ZF type oil seals are also available instead of GS type seals.
 8. The dimension Y indicates the distance from the bearing center to the outer side face of the nut.

Plummer Block Housings
SN5, SN6, SN30, SN31 Series
for Bearing with Adapter Sleeve
 Shaft Diameter: 60~90mm

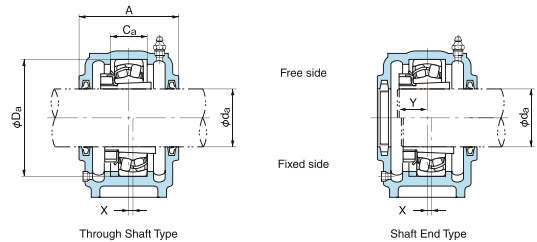
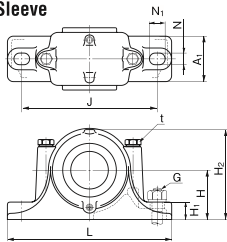

Shaft dia. da (mm)	Dimensions (mm)													Mass (kg) (Reference)	Designations		Applicable parts							Y (Reference)
	Da (H8)	H (h13)	J	N	N1	A	L	A1	H1	H2	Ca (H13)	G (Nominal)	I (Nominal) (Reference)		Through Shaft Type	Shaft End Type	Self-aligning ball bearings	Spherical roller bearings	Adapter sleeve	Oil seal	Locating ring			
																					Designations	Q'ty		
60	120	80	230	18	23	110	275	80	30	150	43	M16	M12	5.6	SN513	SN513E	1213K 2213K	— 22213EXK	H213X H313X	GS13	SR120 × 10 SR120 × 12	2 1	28 32	
	140	95	260	22	27	130	315	90	32	175	58	M20	M16	8.7	SN613	SN613E	1313K 2313K	21313EK 22313EXK	H313X H2313X	GS13	SR140 × 12.5 SR140 × 10	2 1	33 40	
65	130	80	230	18	23	115	280	80	30	155	41	M16	M12	7.0	SN515	SN515E	1215K 2215K	— 22215EXK	H215X H315X	GS15	SR130 × 8 SR130 × 10	2 1	30 33	
	160	100	290	22	27	140	345	100	35	195	65	M20	M16	11	SN615	SN615E	1315K 2315K	21315EK 22315EXK	H315X H2315X	GS15	SR160 × 14 SR160 × 10	2 1	36 45	
70	140	95	260	22	27	120	315	90	32	175	43	M20	M16	9.0	SN516	SN516E	1216K 2216K	— 22216EXK	H216X H316X	GS16	SR140 × 8.5 SR140 × 10	2 1	32 36	
	170	112	290	22	27	145	345	100	35	212	68	M20	M16	13	SN616	SN616E	1316K 2316K	21316EK 22316EXK	H316X H2316X	GS16	SR170 × 14.5 SR170 × 10	2 1	39 48	
75	150	95	260	22	27	125	320	90	32	185	46	M20	M16	10	SN517	SN517E	1217K 2217K	— 22217EXK	H217X H317X	GS17	SR150 × 9 SR150 × 10	2 1	34 38	
	180	112	320	26	32	155	380	110	40	223	70	M24	M20	15	SN617	SN617E	1317K 2317K	21317EK 22317EXK	H317X H2317X	GS17	SR180 × 14.5 SR180 × 10	2 1	41 50	
80	160	100	290	22	27	145	345	100	35	195	62.4	M20	M16	13	SN518	SN518E	1218K 2218K	— 22218EXK	H218X H318X	GS18	SR160 × 16.2 SR160 × 11.2	2 2	35 40	
	190	112	320	26	32	160	380	110	40	230	74	M24	M20	19	SN618	SN618E	1318K 2318K	21318EK 22318EXK	H318X H2318X	GS18	SR190 × 15.5 SR190 × 10	2 1	42 52	
85	170	112	290	22	27	140	345	100	35	210	53	M20	M16	15	SN519	SN519E	1219K 2219K	— 22219EXK	H219X H319X	GS19	SR170 × 10.5 SR170 × 10	2 1	37 43	
	200	125	350	26	32	170	410	120	45	250	77	M24	M20	22	SN619	SN619E	1319K 2319K	21319EK 22319EXK	H319X H2319X	GS19	SR200 × 16 SR200 × 10	2 1	44 55	
90	180	112	320	26	32	160	380	110	40	218	70.3	M24	M20	19	SN520	SN520E	1220K 2220K	— 22220EXK	H220X H320X	GS20	SR180 × 18.1 SR180 × 12.1	2 2	39 45	
	215	140	350	26	32	175	410	120	45	270	83	M24	M20	25	SN620	SN620E	1320K 2320K	21320EK 22320EXK	H320X H2320X	GS20	SR215 × 18 SR215 × 10	2 1	46 59	

Remarks: 1. Plummer block housings are housings with oil seals, a plug and a grease nipple only.
 To make a complete unit, please order the corresponding bearing, adapter sleeve and locating rings shown in the table additionally.
 2. The masses in the table do not include the bearing, adapter sleeve and locating rings but the bolts.
 3. H8, H13 and h13 in the table means tolerance classes specified in JIS B 0401.
 4. The tolerance of locating ring O.D. is h12, and 0 ~ -0.2 for the width.

5. Plummer block housings SN3028, SN3126, SN524, SN620 and larger are provided with eye bolts.
 6. When one locating ring is used for fixed-end, the offset (X dimension) of bearing center from the center of the plummer block housing is a half of the locating ring width.
 7. The threads for plugs are PT1/8 for SN519, SN616 and smaller, and PT1/4 for the others.
 8. ZF type oil seals are also available instead of GS type seals.
 9. The dimension Y indicates the distance from the bearing center to the outer side face of the nut.

Plummer Block Housings
SN5, SN6, SN30, SN31 Series
for Bearing with Adapter Sleeve
 Shaft Diameter: 100~135mm

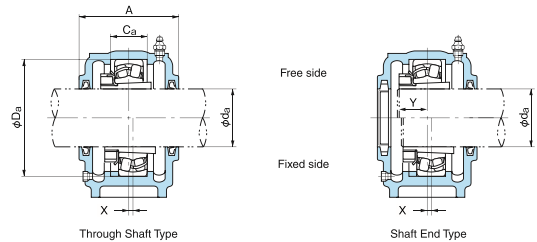
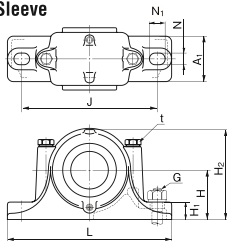

Shaft dia. da (mm)	Dimensions (mm)													Mass (kg) (Reference)	Designations		Applicable parts							
	Da (H8)	H (h13)	J	N	N1	A	L	A1	H1	H2	Ca (H13)	G (Nominal)	I (Nominal) (Reference)		Through Shaft Type	Shaft End Type	Self-aligning ball bearings	Spherical roller bearings	Adapter sleeve	Oil seal	Locating ring		Y (Reference)	
																					Designations	Q'ty		
100	180	112	320	26	32	155	380	110	40	223	66	M24	M20	18	SN3122	SN3122E	—	23122EK	H3122X	GS22	SR180 × 10	1	51	
	200	125	350	26	32	175	410	120	45	240	80	M24	M20	20	SN522	SN522E	1222K	—	H222X	GS22	SR200 × 21	2	42	
																	2222K	22222EXK	H322X	—	SR200 × 13.5	2	50	
																		—	23222EK	H2322X	—	SR200 × 10	1	58
110	240	150	390	28	36	190	450	130	50	300	90	M24	M24	32	SN622	SN622E	1322K	21322EK	H322X	GS22	SR240 × 20	2	48	
																	2322K	22322EXK	H2322X	—	SR240 × 10	1	63	
	180	112	320	26	32	150	380	110	40	223	56	M24	M20	16	SN3024	SN3024E	—	23024EK	H3024X	GS24	SR180 × 10	1	47	
	200	125	350	26	32	165	410	120	45	245	72	M24	M20	20	SN3124	SN3124E	—	23124EK	H3124X	GS24	SR200 × 10	1	55	
115	215	140	350	26	32	185	410	120	45	270	86	M24	M20	25	SN524	SN524E	—	22224EK	H3124X	GS24	SR215 × 14	2	53	
																	—	23224EK	H2324X	—	SR215 × 10	1	62	
	260	160	450	33	42	200	530	160	60	320	96	M30	M24	48	SN624	SN624E	—	22324EK	H2324X	GS24	SR260 × 10	1	67	
																		—	23026EK	H3026	GS26	SR200 × 10	1	51
125	200	125	350	26	32	160	410	120	45	245	62	M24	M20	19	SN3026	SN3026E	—	23026EK	H3126	GS26	SR210 × 10	1	57	
	210	140	350	26	32	170	410	120	45	270	74	M24	M20	26	SN3126	SN3126E	—	23126EK	H3126	GS26	SR210 × 10	1	57	
	230	150	380	28	36	190	445	130	50	290	90	M24	M24	30	SN526	SN526E	—	22226EK	H3126	GS26	SR230 × 13	2	57	
																		—	23226EK	H2326	—	SR230 × 10	1	65
135	280	170	470	33	42	210	550	160	60	340	103	M30	M24	56	SN626	SN626E	—	22326EK	H2326	GS26	SR280 × 10	1	72	
	210	140	350	26	32	170	410	120	45	270	63	M24	M20	25	SN3028	SN3028E	—	23028EK	H3028	GS28	SR210 × 10	1	53	
	225	150	380	28	36	180	445	130	50	290	78	M24	M24	32	SN3128	SN3128E	—	23128EK	H3128	GS28	SR225 × 10	1	60	
	250	150	420	33	42	205	500	150	50	305	98	M30	M24	38	SN528	SN528E	—	22228EXK	H3128	GS28	SR250 × 15	2	60	
135	300	180	520	35	45	235	610	170	65	365	112	M30	M30	72	SN628	SN628E	—	22328EK	H2328	GS28	SR250 × 10	1	70	
																		—	23228EK	H2328	—	SR300 × 10	1	77
	225	150	380	28	36	175	445	130	50	290	66	M24	M24	29	SN3030	SN3030E	—	23030EK	H3030	GS30	SR225 × 10	1	56	
	250	150	420	33	42	200	500	150	50	305	90	M30	M24	38	SN3130	SN3130E	—	23130EK	H3130	GS30	SR250 × 10	1	68	
135	270	160	450	33	42	220	530	160	60	325	106	M30	M24	46	SN530	SN530E	—	22230EK	H3130	GS30	SR270 × 16.5	2	65	
	320	190	560	35	45	245	650	180	65	385	118	M30	M30	98	SN630	SN630E	—	22330EK	H2330	GS30	SR270 × 10	1	76	
																		—	22330EK	H2330	GS30	SR320 × 10	1	82

Remarks: 1. Plummer block housings are housings with oil seals, a plug and a grease nipple only.
 To make a complete unit, please order the corresponding bearing, adapter sleeve and locating rings shown in the table additionally.
 2. The masses in the table do not include the bearing, adapter sleeve and locating rings but the bolts.
 3. H8, H13 and h13 in the table means tolerance classes specified in JIS B 0401.
 4. The tolerance of locating ring O.D. is h12, and 0 ~ -0.2 for the width.

5. Plummer block housings SN3028, SN3126, SN524, SN620 and larger are provided with eye bolts.
 6. When one locating ring is used for fixed-end, the offset (X dimension) of bearing center from the center of the plummer block housing is a half of the locating ring width.
 7. The threads for plugs are PT1/4.
 8. ZF type oil seals are also available instead of GS type seals.
 9. The dimension Y indicates the distance from the bearing center to the outer side face of the nut.

Plummer Block Housings
SN5, SN6, SN30, SN31 Series
for Bearing with Adapter Sleeve
 Shaft Diameter: 140~170mm

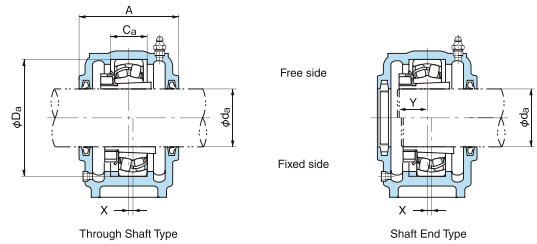
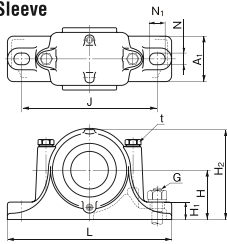

Shaft dia. da (mm)	Dimensions (mm)													Mass (kg) (Reference)	Designations		Applicable parts					Y (Reference)
	Da (H8)	H (h13)	J	N	N1	A	L	A1	H1	H2	Ca (H13)	G (Nominal)	I (Nominal Reference)		Through Shaft Type	Shaft End Type	Spherical roller bearings	Adapter sleeve	Oil seal	Locating ring		
																				Designations	Q'ty	
140	240	150	390	28	36	190	450	130	50	300	70	M24	M24	32	SN3032	SN3032E	23032EK	H3032	GS32	SR240 x 10	1	61
	270	160	450	33	42	215	530	160	60	325	96	M30	M24	48	SN3132	SN3132E	23132EK	H3132	GS32	SR270 x 10	1	74
	290	170	470	33	42	235	550	160	60	345	114	M30	M24	50	SN532	SN532E	22232EK	H3132	GS32	SR290 x 17	2	71
150	340	200	580	42	50	255	680	190	70	405	124	M36	M30	115	SN632	SN632E	23232EK	H2332	GS32	SR290 x 10	1	83
	260	160	450	33	42	200	530	160	60	320	77	M30	M24	40	SN3034	SN3034E	23034EK	H3034	GS34	SR260 x 10	1	66
	280	170	470	33	42	220	550	160	60	340	98	M30	M24	58	SN3134	SN3134E	23134EK	H3134	GS34	SR280 x 10	1	76
160	280	170	470	33	42	210	550	160	60	340	84	M30	M24	50	SN3036	SN3036E	23036EK	H3036	GS36	SR280 x 10	1	70
	300	180	520	35	45	230	610	170	65	365	106	M30	M30	70	SN3136	SN3136E	23136EK	H3136	GS36	SR300 x 10	1	81
	290	170	470	33	42	210	550	160	60	345	85	M30	M24	55	SN3038	SN3038E	23038EK	H3038	GS38	SR290 x 10	1	72
170	320	190	560	35	45	240	650	180	65	385	114	M30	M30	90	SN3138	SN3138E	23138EK	H3138	GS38	SR320 x 10	1	86

Remarks: 1. Plummer block housings are housings with oil seals, a plug and a grease nipple only.
 To make a complete unit, please order the corresponding bearing, adapter sleeve and locating rings shown in the table additionally.
 2. The masses in the table do not include the bearing, adapter sleeve and locating rings but the bolts.
 3. H8, H13 and h13 in the table means tolerance classes specified in JIS B 0401.
 4. The tolerance of locating ring O.D. is h12, and 0 ~ -0.2 for the width.

5. Plummer block housings SN3028, SN3126, SN524, SN620 and larger are provided with eye bolts.
 6. When one locating ring is used for fixed-end, the offset (X dimension) of bearing center from the center of the plummer block housing is a half of the locating ring width.
 7. The threads for plugs are PT1/4.
 8. ZF type oil seals are also available instead of GS type seals.
 9. The dimension Y indicates the distance from the bearing center to the outer side face of the nut.

Plummer Block Housings
Flat Bottom Type SN5F, SN6F Series
for Bearing with Adapter Sleeve
 Shaft Diameter: 20~55mm

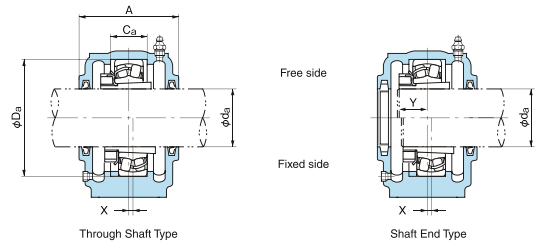
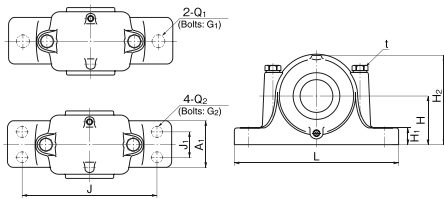

Shaft dia. da (mm)	Dimensions (mm)									Bolt holes (Reference) (mm)						l (Nominal Reference)	Mass (kg) (Reference)	Designations		Applicable parts							Y (Reference)		
	Da (H8)	H (h13)	A	L	A1	H1	H2	Ca (H13)	J	Q1	G1 (Nominal)	J1	Q2	G2 (Nominal)	M			8	M	8	Through Shaft Type	Shaft End Type	Self-aligning ball bearings	Spherical roller bearings	Adapter sleeve	Oil seal		Locating ring	
																												Designations	Q'ty
20	52	40	67	165	46	22	75	25	130	15	M12	25	10	M 8	M 8	1.7			SN505F	SN505FE	1205K	—	H205X	GS 5	SR52 × 5	2	17		
																			SN505F	SN505FE	2205K	22205EXK	H305X	GS 5	SR52 × 7	1	19		
	62	50	80	185	52	22	90	34	150	15	M12	25	12	M10	M 8	2.4			SN605F	SN605FE	1305K	21305EK	H305X	GS 5	SR62 × 8.5	2	18		
																				SN605F	SN605FE	2305K	—	H2305X	GS 5	SR62 × 10	1	22	
25	62	50	77	185	52	22	90	30	150	15	M12	25	12	M10	M 8	2.5			SN506F	SN506FE	1206K	—	H206X	GS 6	SR62 × 7	2	18		
																			SN606F	SN606FE	2206K	22206EXK	H306X	GS 6	SR62 × 10	1	20		
	72	50	82	185	52	22	95	37	150	15	M12	25	12	M10	M10	2.5			SN606F	SN606FE	1306K	21306EK	H306X	GS 6	SR72 × 9	2	19		
																				SN606F	SN606FE	2306K	—	H2306X	GS 6	SR72 × 10	1	23	
30	72	50	82	185	52	22	95	33	150	15	M12	25	12	M10	M10	2.6			SN507F	SN507FE	1207K	—	H207X	GS 7	SR72 × 8	2	19		
																			SN607F	SN607FE	2207K	22207EXK	H307X	GS 7	SR72 × 10	1	22		
	80	60	90	205	60	25	110	41	170	15	M12	30	12	M10	M10	3.8			SN607F	SN607FE	1307K	21307EK	H307X	GS 7	SR80 × 10	2	21		
																				SN607F	SN607FE	2307K	—	H2307X	GS 7	SR80 × 10	1	26	
35	80	60	85	205	60	25	110	33	170	15	M12	30	12	M10	M10	4.0			SN508F	SN508FE	1208K	—	H208X	GS 8	SR80 × 7.5	2	21		
																			SN608F	SN608FE	2208K	22208EXK	H308X	GS 8	SR80 × 10	1	23		
	90	60	95	205	60	25	115	43	170	15	M12	30	12	M10	M10	4.0			SN608F	SN608FE	1308K	21308EK	H308X	GS 8	SR90 × 10	2	23		
																				SN608F	SN608FE	2308K	22308EXK	H2308X	GS 8	SR90 × 10	1	28	
40	85	60	85	205	60	25	112	31	170	15	M12	30	12	M10	M10	4.4			SN509F	SN509FE	1209K	—	H209X	GS 9	SR85 × 6	2	22		
																			SN609F	SN609FE	2209K	22209EXK	H309X	GS 9	SR85 × 8	1	24		
	100	70	105	255	70	28	130	46	210	19	M16	35	15	M12	M12	6.0			SN609F	SN609FE	1309K	21309EK	H309X	GS 9	SR100 × 10.5	2	25		
																				SN609F	SN609FE	2309K	22309EXK	H2309X	GS 9	SR100 × 10	1	31	
45	90	60	90	205	60	25	115	33	170	15	M12	30	12	M10	M10	4.7			SN510F	SN510FE	1210K	—	H210X	GS10	SR90 × 6.5	2	24		
																			SN610F	SN610FE	2210K	22210EXK	H310X	GS10	SR90 × 10	1	25		
	110	70	115	255	70	30	135	50	210	19	M16	35	15	M12	M12	6.5			SN610F	SN610FE	1310K	21310EK	H310X	GS10	SR110 × 11.5	2	27		
																				SN610F	SN610FE	2310K	22310EXK	H2310X	GS10	SR110 × 10	1	34	
50	100	70	95	255	70	28	130	33	210	19	M16	35	15	M12	M12	6.3			SN511F	SN511FE	1211K	—	H211X	GS11	SR100 × 6	2	25		
																			SN611F	SN611FE	2211K	22211EXK	H311X	GS11	SR100 × 8	1	27		
	120	80	120	275	80	30	150	53	230	19	M16	40	15	M12	M12	8.5			SN611F	SN611FE	1311K	21311EK	H311X	GS11	SR120 × 12	2	29		
																				SN611F	SN611FE	2311K	22311EXK	H2311X	GS11	SR120 × 10	1	36	
55	110	70	105	255	70	30	135	38	210	19	M16	35	15	M12	M12	6.9			SN512F	SN512FE	1212K	—	H212X	GS12	SR110 × 8	2	26		
																			SN612F	SN612FE	2212K	22212EXK	H312X	GS12	SR110 × 10	1	29		
	130	80	125	280	80	30	155	56	230	19	M16	40	15	M12	M12	9.0			SN612F	SN612FE	1312K	21312EK	H312X	GS12	SR130 × 12.5	2	31		
																				SN612F	SN612FE	2312K	22312EXK	H2312X	GS12	SR130 × 10	1	39	

Remarks: 1. Plummer block housings are housings with oil seals, a plug and a grease nipple only.
 To make a complete unit, please order the corresponding bearing, adapter sleeve and locating rings shown in the table additionally.
 2. The masses in the table do not include the bearing, adapter sleeve and locating rings but the bolts.
 3. H8, H13 and h13 in the table means tolerance classes specified in JIS B 0401.
 4. The tolerance of locating ring O.D. is h12, and 0 ~ -0.2 for the width.

5. When one locating ring is used for fixed-end, the offset (X dimension) of bearing center from the center of the plummer block housing is a half of the locating ring width.
 6. The threads for plugs are PT1/8. SN505F does not have a drain hole.
 7. ZF type oil seals are also available instead of GS type seals.
 8. Please specify number of bolt holes.
 9. The dimension Y indicates the distance from the bearing center to the outer side face of the nut.

Plummer Block Housings
Flat Bottom Type SN5F, SN6F Series
for Bearing with Adapter Sleeve
Shaft Diameter: 60~90mm

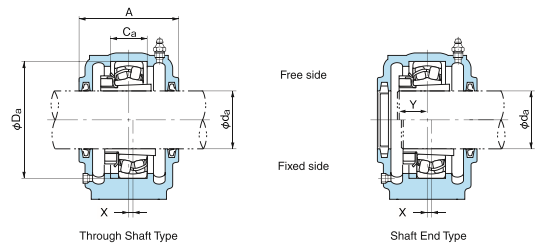
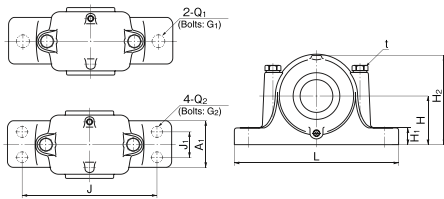

Shaft dia. da (mm)	Dimensions (mm)								Bolt holes (Reference)						l (Nominal Reference)	Mass (kg) (Reference)	Designations	Applicable parts							
	D _a (H8)	H (h13)	A	L	A ₁	H ₁	H ₂	C _a (H13)	J	Q ₁	G ₁ (Nominal)	J ₁	Q ₂	G ₂ (Nominal)				Through Shaft Type	Shaft End Type	Self-aligning ball bearings	Spherical roller bearings	Adapter sleeve	Oil seal	Locating ring	
																					Designations	Q'ty			
60	120	80	110	275	80	30	150	43	230	19	M16	40	15	M12	M12	7.0									
	140	95	130	315	90	32	175	58	260	24	M20	50	19	M16	M16	13									
65	130	80	115	280	80	30	155	41	230	19	M16	40	15	M12	M12	8.8									
	160	100	140	345	100	35	195	65	290	24	M20	50	19	M16	M16	16									
70	140	95	120	315	90	32	175	43	260	24	M20	50	19	M16	M16	13									
	170	112	145	345	100	35	212	68	290	24	M20	50	19	M16	M16	17									
75	150	95	125	320	90	32	185	46	260	24	M20	50	19	M16	M16	14									
	180	112	155	380	110	40	223	70	320	28	M24	60	24	M20	M20	24									
80	160	100	145	345	100	35	195	62.4	290	24	M20	50	19	M16	M16	18									
	190	112	160	380	110	40	230	74	320	28	M24	60	24	M20	M20	26									
85	170	112	140	345	100	35	210	53	290	24	M20	50	19	M16	M16	20									
	200	125	170	410	120	45	250	77	350	28	M24	70	24	M20	M20	30									
90	180	112	160	380	110	40	218	70.3	320	28	M24	60	24	M20	M20	26									
	215	140	175	410	120	45	270	83	350	28	M24	70	24	M20	M20	35									

Remarks: 1. Plummer block housings are housings with oil seals, a plug and a grease nipple only.
To make a complete unit, please order the corresponding bearing, adapter sleeve and locating rings shown in the table additionally.
2. The masses in the table do not include the bearing, adapter sleeve and locating rings but the bolts.
3. H8, H13 and h13 in the table means tolerance classes specified in JIS B 0401.
4. The tolerance of locating ring O.D. is h12, and 0 ~ -0.2 for the width.

5. Plummer block housings SN524F, SN620F and larger are provided with eye bolts.
6. When one locating ring is used for fixed-end, the offset (X dimension) of bearing center from the center of the plummer block housing is a half of the locating ring width.
7. The threads for plugs are PT1/8 for SN519F, SN616F and smaller, and PT1/4 for the others.
8. ZF type oil seals are also available instead of GS type seals.
9. Please specify number of bolt holes.
10. The dimension Y indicates the distance from the bearing center to the outer side face of the nut.

Plummer Block Housings
Flat Bottom Type SN5F, SN6F Series
for Bearing with Adapter Sleeve
 Shaft Diameter: 100~140mm

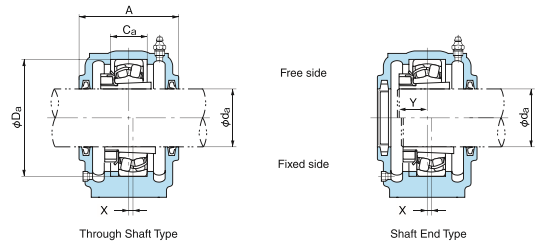
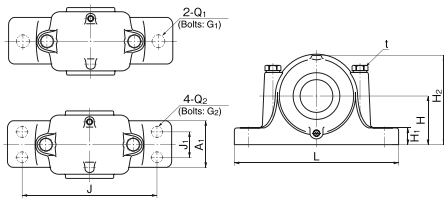

Shaft dia. da (mm)	Dimensions (mm)								Bolt holes (Reference)						t (Nominal) (Reference)	Mass (kg) (Reference)	Designations		Applicable parts						
	Da (H8)	H (h13)	A	L	A1	H1	H2	Ca (H13)	J	Q1	G1 (Nominal)	J1	Q2	G2 (Nominal)			Through Shaft Type	Shaft End Type	Self-aligning ball bearings	Spherical roller bearings	Adapter sleeve	Oil seal	Locating ring		Y (Reference)
																					Designations	Q'ty			
100	200	125	175	410	120	45	240	80	350	28	M24	70	24	M20	M20	28									
	240	150	190	450	130	50	300	90	390	28	M24	70	28	M24	M24	45									
110	215	140	185	410	120	45	270	86	350	28	M24	70	24	M20	M20	35									
	260	160	200	530	160	60	320	96	450	35	M30	90	28	M24	M24	63									
115	230	150	190	445	130	50	290	90	380	28	M24	70	28	M24	M24	42									
	280	170	210	550	160	60	340	103	470	35	M30	90	28	M24	M24	74									
125	250	160	205	500	150	50	305	98	420	35	M30	80	28	M24	M24	52									
	300	180	235	610	170	65	365	112	520	35	M30	100	28	M24	M30	92									
135	270	160	220	530	160	60	325	106	450	35	M30	90	28	M24	M24	61									
	320	190	245	650	180	65	385	118	560	35	M30	110	28	M24	M30	120									
140	290	170	235	550	160	60	345	114	470	35	M30	90	28	M24	M24	68									
	340	200	255	680	190	70	405	124	580	42	M36	110	35	M30	M30	140									

Remarks: 1. Plummer block housings are housings with oil seals, a plug and a grease nipple only.
 To make a complete unit, please order the corresponding bearing, adapter sleeve and locating rings shown in the table additionally.
 2. The masses in the table do not include the bearing, adapter sleeve and locating rings but the bolts.
 3. H8, H13 and h13 in the table means tolerance classes specified in JIS B 0401.
 4. The tolerance of locating ring O.D. is h12, and 0 - -0.2 for the width.

5. Plummer block housings SN524F, SN620F and larger are provided with eye bolts.
 6. When one locating ring is used for fixed-end, the offset (X dimension) of bearing center from the center of the plummer block housing is a half of the locating ring width.
 7. The threads for plugs are PT1/4.
 8. ZF type oil seals are also available instead of GS type seals.
 9. Please specify number of bolt holes.
 10. The dimension Y indicates the distance from the bearing center to the outer side face of the nut.

Plummer Block Housings
SN2, SN3 Series
for Bearing with Cylindrical Bore
 Shaft Diameter: 25~55mm

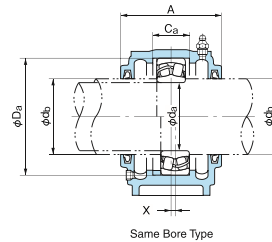
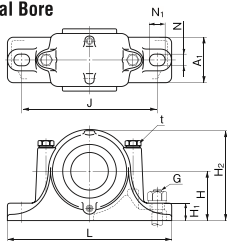

Free side
Fixed side

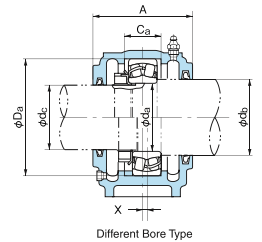

Shaft dia. (mm)			Dimensions (mm)													Mass (kg) (Reference)	Designations		Applicable parts								Y (Reference)				
da	db	dc	D _a (H8)	H (h13)	J	N	N ₁	A	L	A ₁	H ₁	H ₂	C _a (H13)	G (Nominal)	t (Nominal) (Reference)		Same Bore Type	Different Bore Type	Self-aligning ball bearings	Spherical roller bearings	Nut	Locking washer	Oil seal		Locating ring						
																						db side	dc side	Designations	Q'ty						
25	30(*)	20	52	40	130	15	20	67	165	46	22	75	25	M12	M 8	1.1	SN205	SN205C	1205	—	AN05	AW05X	GS 7	GS 5	SR52 × 5	2	17				
			2205	22205EX	—	—	—	—	—	—	—	—	—	—	—	—	—	—	—	—	—	—	—	—	—	—	—	—	—	—	
			62	50	150	15	20	80	185	52	22	90	34	M12	M 8	1.6	SN305	SN305C	1305	21305E	AN05	AW05X	GS 7	GS 5	SR62 × 7	1	19				
30	35(*)	25	62	50	150	15	20	77	185	52	22	90	30	M12	M 8	1.7	SN206	SN206C	1206	—	AN06	AW06X	GS 8	GS 6	SR62 × 7	2	18				
			2206	22206EX	—	—	—	—	—	—	—	—	—	—	—	—	—	—	—	—	—	—	—	—	—	—	—	—	—	—	
			72	50	150	15	20	82	185	52	22	95	37	M12	M10	1.8	SN306	SN306C	1306	21306E	AN06	AW06X	GS 8	GS 6	SR62 × 10	1	20				
35	45	30	72	50	150	15	20	82	185	52	22	95	33	M12	M10	1.9	SN207	SN207C	1207	—	AN07	AW07X	GS10	GS 7	SR72 × 9	2	19				
			2207	22207EX	—	—	—	—	—	—	—	—	—	—	—	—	—	—	—	—	—	—	—	—	—	—	—	—	—	—	—
			80	60	170	15	20	90	205	60	25	110	41	M12	M10	2.6	SN307	SN307C	1307	21307E	AN07	AW07X	GS10	GS 7	SR72 × 10	1	22				
40	50	35	80	60	170	15	20	85	205	60	25	110	33	M12	M10	2.6	SN208	SN208C	1208	—	AN08	AW08X	GS11	GS 8	SR80 × 7.5	2	21				
			2208	22208EX	—	—	—	—	—	—	—	—	—	—	—	—	—	—	—	—	—	—	—	—	—	—	—	—	—	—	—
			90	60	170	15	20	95	205	60	25	115	43	M12	M10	2.9	SN308	SN308C	1308	21308E	AN08	AW08X	GS11	GS 8	SR80 × 10	1	23				
45	55	40	85	60	170	15	20	85	205	60	25	112	31	M12	M10	2.8	SN209	SN209C	1209	—	AN09	AW09X	GS12	GS 9	SR85 × 6	2	22				
			2209	22209EX	—	—	—	—	—	—	—	—	—	—	—	—	—	—	—	—	—	—	—	—	—	—	—	—	—	—	—
			100	70	210	18	23	105	255	70	28	130	46	M16	M12	4.1	SN309	SN309C	1309	21309E	AN09	AW09X	GS12	GS 9	SR85 × 8	1	24				
50	60	45	90	60	170	15	20	90	205	60	25	115	33	M12	M10	3.0	SN210	SN210C	1210	—	AN10	AW10X	GS13	GS10	SR85 × 10	2	24				
			2210	22210EX	—	—	—	—	—	—	—	—	—	—	—	—	—	—	—	—	—	—	—	—	—	—	—	—	—	—	—
			110	70	210	18	23	115	255	70	30	135	50	M16	M12	4.7	SN310	SN310C	1310	21310E	AN10	AW10X	GS13	GS10	SR90 × 10	1	25				
55	65	50	100	70	210	18	23	95	255	70	28	130	33	M16	M12	4.5	SN211	SN211C	1211	—	AN11	AW11X	GS15	GS11	SR100 × 10	1	34				
			2211	22211EX	—	—	—	—	—	—	—	—	—	—	—	—	—	—	—	—	—	—	—	—	—	—	—	—	—	—	
			120	80	230	18	23	120	275	80	30	150	53	M16	M12	5.8	SN311	SN311C	1311	21311E	AN11	AW11X	GS15	GS11	SR90 × 6.5	2	24				

Note: (*) When heavy axial load is applied, a spacer with large O.D. and small inner chamfer must be used between the bearing and shaft shoulder to obtain a sufficient contact area.

Remarks: 1. Plummer block housings are housings with oil seals, a plug and a grease nipple only.
 To make a complete unit, please order the corresponding bearing, adapter sleeve and locating rings shown in the table additionally.
 2. The masses in the table do not include the bearing, nut and locating rings but the bolts.
 3. H8, H13 and h13 in the table means tolerance classes specified in JIS B 0401.
 4. The tolerance of locating ring O.D. is h12, and D ~ -0.2 for the width.

5. The threads for plugs are PT1/8. SN205 does not have a drain hole.
 6. When one locating ring is used for fixed-end, the offset (X dimension) of bearing center from the center of the plummer block housing is a half of the locating ring width.
 7. ZF type oil seals are also available instead of GS type seals.
 8. SNxxx type housings for shaft diameters different from the dimensions db or dc shown in the table can be custom ordered.
 9. The dimension Y indicates the distance from the bearing center to the outer side face of the nut.

Plummer Block Housings
SN2, SN3 Series
for Bearing with Cylindrical Bore
 Shaft Diameter: 60~95mm

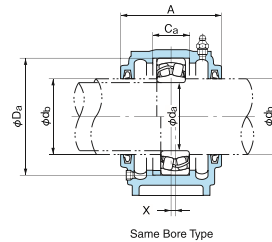
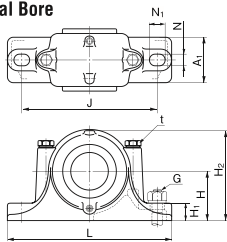

Free side
Fixed side

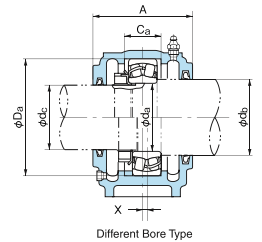

Shaft dia. (mm)		Dimensions (mm)														Mass (kg) (Reference)	Designations		Applicable parts									
da	db	dc	Da (H8)	H (h13)	J	N	N1	A	L	A1	H1	H2	Ca (H13)	G (Nominal)	t (Nominal Reference)		Same Bore Type	Different Bore Type	Self-aligning ball bearings	Spherical roller bearings	Nut	Locking washer	Oil seal		Locating ring		Y (Reference)	
																						db side	dc side	Designations	Q'ty			
60	70	55	110	70	210	18	23	105	255	70	30	135	38	M16	M12	5.0	SN212	SN212C	1212 2212 22212EX	—	AN12	AW12X	GS16	GS12	SR110×8 SR110×10 SR130×12.5 SR130×10	2 1 2 1	26 29 31 39	
	70(*)	55	130	80	230	18	23	125	280	80	30	155	56	M16	M12	6.5	SN312	SN312C	1312 21312E 2312	21312E	AN12	AW12X	GS16	GS12	SR130×12.5 SR130×10	2 1	31 39	
65	75	60	120	80	230	18	23	110	275	80	30	150	43	M16	M12	5.6	SN213	SN213C	1213 2213 22213EX	—	AN13	AW13X	GS17	GS13	SR120×10 SR120×12 SR140×12.5 SR140×10	2 1 2 1	28 32 33 40	
	75(*)	60	140	95	260	22	27	130	315	90	32	175	58	M20	M16	8.7	SN313	SN313C	1313 21313E 2313	21313E	AN13	AW13X	GS17	GS13	SR140×12.5 SR140×10	2 1	33 40	
70	80	65	125	80	230	18	23	115	275	80	30	155	44	M16	M12	6.2	SN214	SN214C	1214 2214 22214EX	—	AN14	AW14X	GS18	GS15	SR125×10 SR150×13 SR150×10	2 1 1	28 32 42	
	80(*)	65	150	95	260	22	27	130	320	90	32	185	61	M20	M16	10	SN314	SN314C	1314 21314E 2314	21314E	AN14	AW14X	GS18	GS15	SR150×13 SR150×10	2 1	34 42	
75	85	70	130	80	230	18	23	115	280	80	30	155	41	M16	M12	7.0	SN215	SN215C	1215 2215 22215EX	—	AN15	AW15X	GS19	GS16	SR130×8 SR130×10 SR160×14 SR160×10	2 1 2 1	30 33 36 45	
	85(*)	70	160	100	290	22	27	140	345	100	35	195	65	M20	M16	11	SN315	SN315C	1315 21315E 2315	21315E	AN15	AW15X	GS19	GS16	SR160×14 SR160×10	2 1	36 45	
80	90	75	140	95	260	22	27	120	315	90	32	175	43	M20	M16	9.0	SN216	SN216C	1216 2216 22216EX	—	AN16	AW16X	GS20	GS17	SR140×8.5 SR140×10 SR170×14.5 SR170×10	2 1 2 1	32 36 39 48	
	90(*)	75	170	112	290	22	27	145	345	100	35	212	68	M20	M16	13	SN316	SN316C	1316 21316E 2316	21316E	AN16	AW16X	GS20	GS17	SR170×14.5 SR170×10	2 1	39 48	
85	95	80	150	95	260	22	27	125	320	90	32	185	46	M20	M16	10	SN217	SN217C	1217 2217 22217EX	—	AN17	AW17X	GS21	GS18	SR150×9 SR150×10 SR180×14.5 SR180×10	2 1 2 1	34 38 41 50	
	95(*)	80	180	112	320	26	32	155	380	110	40	223	70	M24	M20	15	SN317	SN317C	1317 21317E 2317	21317E	AN17	AW17X	GS21	GS18	SR180×14.5 SR180×10	2 1	41 50	
90	100	85	160	100	290	22	27	145	345	100	35	195	62.4	M20	M16	13	SN218	SN218C	1218 2218 23218E	—	AN18	AW18X	GS22	GS19	SR160×16.2 SR160×11.2 SR160×10	2 2 1	35 40 46	
	95	110	90	170	112	290	22	27	140	345	100	35	210	53	M20	M16	15	SN219	SN219C	1219 2219 22219EX	—	AN19	AW19X	GS24	GS20	SR170×10.5 SR170×10	2 1	37 43

Note: (*) When heavy axial load is applied, a spacer with large O.D. and small inner chamfer must be used between the bearing and shaft shoulder to obtain a sufficient contact area.
 Remarks: 1. Plummer block housings are housings with oil seals, a plug and a grease nipple only.
 To make a complete unit, please order the corresponding bearing, adapter sleeve and locating rings shown in the table additionally.
 2. The masses in the table do not include the bearing, nut and locating rings but the bolts.
 3. H8, H13 and h13 in the table means tolerance classes specified in JIS B 0401.
 4. The tolerance of locating ring O.D. is h12, and 0 ~ -0.2 for the width.

5. Plummer block housings SN224 and larger are provided with eye bolts.
 6. The threads for plugs are PT1/8 for SN316F and smaller, and PT1/4 for the others.
 7. When one locating ring is used for fixed-end, the offset (X dimension) of bearing center from the center of the plummer block housing is a half of the locating ring width.
 8. ZF type oil seals are also available instead of GS type seals.
 9. SNxxxC type housings for different shaft diameters db or dc from the dimensions shown above are also available.
 10. The dimension Y indicates the distance from the bearing center to the outer side face of the nut.

Plummer Block Housings
SN2, SN3 Series
for Bearing with Cylindrical Bore
 Shaft Diameter: 100~160mm

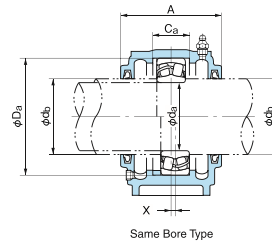
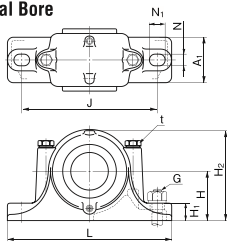

Free side
Fixed side

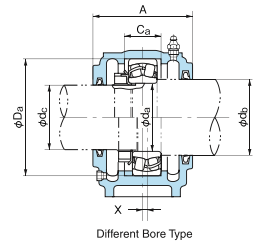

Same Bore Type

Different Bore Type

Shaft dia. (mm)			Dimensions (mm)													Mass (kg) (Reference)	Designations		Applicable parts						Y (Reference)		
da	db	dc	Da (H8)	H (h13)	J	N	N1	A	L	A1	H1	H2	Ca (H13)	G (Nominal)	t (Nominal) (Reference)		Same Bore Type	Different Bore Type	Self-aligning ball bearings	Spherical roller bearings	Nut	Locking washer	Oil seal			Locating ring	
100	115	95	180	112	320	26	32	160	380	110	40	218	70.3	M24	M20	19	SN220	SN220C	1220 2220 —	— 22220EX 23220E	AN20	AW20X	GS26	GS21	SR180×18.1 SR180×12.1 SR180×10	2 2 1	39 45 52
			200	125	350	26	32	175	410	120	45	240	80	M24	M20	20	SN222	SN222C	1222 2222 —	— 22222EX 23222E	AN22	AW22X	GS28	GS23	SR200×21 SR200×13.5 SR200×10	2 2 1	42 50 58
			215	140	350	26	32	185	410	120	45	270	86	M24	M20	25	SN224	SN224C	— —	22224EX 23224E	AN24	AW24X	GS30	GS26	SR215×14 SR215×10	2 1	53 62
130	145	125	230	150	380	28	36	190	445	130	50	290	90	M24	M24	30	SN226	SN226C	— —	22226EX 23226E	AN26	AW26	GS33	GS28	SR230×13 SR230×10	2 1	57 65
			250	150	420	33	42	205	500	150	50	305	98	M30	M24	38	SN228	SN228C	— —	22228EX 23228E	AN28	AW28	GS35	GS30	SR250×15 SR250×10	2 1	60 70
150	165	145	270	160	450	33	42	220	530	160	60	325	106	M30	M24	46	SN230	SN230C	— —	22230EX 23230E	AN30	AW30	GS37	GS33	SR270×16.5 SR270×10	2 1	65 76
			290	170	470	33	42	235	550	160	60	345	114	M30	M24	50	SN232	SN232C	— —	22232EX 23232E	AN32	AW32	GS39	GS34	SR290×17 SR290×10	2 1	71 83

Remarks: 1. Plummer block housings are housings with oil seals, a plug and a grease nipple only.
 To make a complete unit, please order the corresponding bearing, adapter sleeve and locating rings shown in the table additionally.
 2. The masses in the table do not include the bearing, nut and locating rings but the bolts.
 3. H8, H13 and h13 in the table means tolerance classes specified in JIS B 0401.
 4. The tolerance of locating ring O.D. is h12, and 0 ~ -0.2 for the width.

5. Plummer block housings SN224 and larger are provided with eye bolts.
 6. The threads for plugs are PT1/8 for SN316F and smaller, and PT1/4 for the others.
 7. When one locating ring is used for fixed-end, the offset (X dimension) of bearing center from the center of the plummer block housing is a half of the locating ring width.
 8. ZF type oil seals are also available instead of GS type seals.
 9. SNxxx-C type housings for different shaft diameters da or dc from the dimensions shown above are also available.
 10. The dimension Y indicates the distance from the bearing center to the outer side face of the nut.

Plummer Block Housings
Flat Bottom Type SN2F, SN3F Series
for Bearing with Cylindrical Bore
 Shaft Diameter: 25~55mm

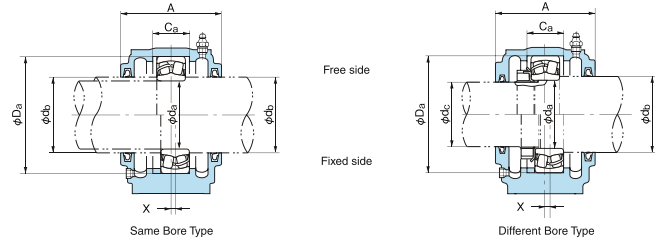
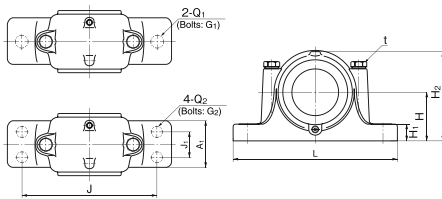

Shaft dia. (mm)	Dimensions (mm)										Bolt holes (Reference)						t (Nominal) (Reference)	Mass (kg) (Reference)	Designations		Applicable parts							Y (Reference)					
	d_a	d_b	d_c	D_a (H8)	H (h13)	A	L	A_1	H_1	H_2	C_a (H13)	J	Q_1	G_1 (Nominal)	J_1	Q_2			G_2 (Nominal)	Same Bore Type	Different Bore Type	Self-aligning ball bearings	Spherical roller bearings	Nut	Locking washer	Oil seal			Locating ring				
25	30(*)	20	52	40	67	165	46	22	75	25	130	15	M12	25	10	M 8	M 8	1.7	SN205F	SN205FC	1205	—	AN05	AW05X	GS 7	GS 5	SR52 × 5	2	17				
			2205	22205EX	—	—	—	—	—	—	—	—	—	—	—	—	—	—	—	—	—	—	—	—	—	—	—	—	—	—	—	—	
			62	50	80	185	52	22	90	34	150	15	M12	25	12	M10	M 8	2.4	SN305F	SN305FC	1305	21305E	AN05	AW05X	GS 7	GS 5	SR62 × 8.5	2	18				
			2305	—	—	—	—	—	—	—	—	—	—	—	—	—	—	—	—	—	—	—	—	—	—	—	—	—	—	—			
30	35(*)	25	62	50	77	185	52	22	90	30	150	15	M12	25	12	M10	M 8	2.5	SN206F	SN206FC	1206	—	AN06	AW06X	GS 8	GS 6	SR62 × 7	2	18				
			2206	22206EX	—	—	—	—	—	—	—	—	—	—	—	—	—	—	—	—	—	—	—	—	—	—	—	—	—	—	—	—	—
			72	50	82	185	52	22	95	37	150	15	M12	25	12	M10	M10	2.5	SN306F	SN306FC	1306	21306E	AN06	AW06X	GS 8	GS 6	SR62 × 10	1	20				
			2306	—	—	—	—	—	—	—	—	—	—	—	—	—	—	—	—	—	—	—	—	—	—	—	—	—	—	—	—		
35	45	30	72	50	82	185	52	22	95	33	150	15	M12	25	12	M10	M10	2.6	SN207F	SN207FC	1207	—	AN07	AW07X	GS10	GS 7	SR72 × 8	2	19				
			2207	22207EX	—	—	—	—	—	—	—	—	—	—	—	—	—	—	—	—	—	—	—	—	—	—	—	—	—	—	—	—	—
			80	60	90	205	60	25	110	41	170	15	M12	30	12	M10	M10	3.8	SN307F	SN307FC	1307	21307E	AN07	AW07X	GS10	GS 7	SR72 × 10	1	22				
			2307	—	—	—	—	—	—	—	—	—	—	—	—	—	—	—	—	—	—	—	—	—	—	—	—	—	—	—	—		
40	50	35	80	60	85	205	60	25	110	33	170	15	M12	30	12	M10	M10	4.0	SN208F	SN208FC	1208	—	AN08	AW08X	GS11	GS 8	SR80 × 7.5	2	21				
			2208	22208EX	—	—	—	—	—	—	—	—	—	—	—	—	—	—	—	—	—	—	—	—	—	—	—	—	—	—	—	—	—
			90	60	95	205	60	25	115	43	170	15	M12	30	12	M10	M10	4.0	SN308F	SN308FC	1308	21308E	AN08	AW08X	GS11	GS 8	SR80 × 10	2	23				
			2308	—	—	—	—	—	—	—	—	—	—	—	—	—	—	—	—	—	—	—	—	—	—	—	—	—	—	—	—		
45	55	40	85	60	85	205	60	25	112	31	170	15	M12	30	12	M10	M10	4.4	SN209F	SN209FC	1209	—	AN09	AW09X	GS12	GS 9	SR85 × 6	2	22				
			2209	22209EX	—	—	—	—	—	—	—	—	—	—	—	—	—	—	—	—	—	—	—	—	—	—	—	—	—	—	—	—	—
			100	70	105	255	70	28	130	46	210	19	M16	35	15	M12	M12	6.0	SN309F	SN309FC	1309	21309E	AN09	AW09X	GS12	GS 9	SR100 × 10.5	2	25				
			2309	—	—	—	—	—	—	—	—	—	—	—	—	—	—	—	—	—	—	—	—	—	—	—	—	—	—	—	—		
50	60	45	90	60	90	205	60	25	115	33	170	15	M12	30	12	M10	M10	4.7	SN210F	SN210FC	1210	—	AN10	AW10X	GS13	GS10	SR90 × 6.5	2	24				
			2210	22210EX	—	—	—	—	—	—	—	—	—	—	—	—	—	—	—	—	—	—	—	—	—	—	—	—	—	—	—	—	
			110	70	115	255	70	30	135	50	210	19	M16	35	15	M12	M12	6.5	SN310F	SN310FC	1310	21310E	AN10	AW10X	GS13	GS10	SR110 × 11.5	2	27				
			2310	—	—	—	—	—	—	—	—	—	—	—	—	—	—	—	—	—	—	—	—	—	—	—	—	—	—	—	—		
55	65	50	100	70	95	255	70	28	130	33	210	19	M16	35	15	M12	M12	6.3	SN211F	SN211FC	1211	—	AN11	AW11X	GS15	GS11	SR100 × 6	2	25				
			2211	22211EX	—	—	—	—	—	—	—	—	—	—	—	—	—	—	—	—	—	—	—	—	—	—	—	—	—	—	—	—	
			120	80	120	275	80	30	150	53	230	19	M16	40	15	M12	M12	8.5	SN311F	SN311FC	1311	21311E	AN11	AW11X	GS15	GS11	SR120 × 12	2	29				
			2311	—	—	—	—	—	—	—	—	—	—	—	—	—	—	—	—	—	—	—	—	—	—	—	—	—	—	—			

Note: (*) When heavy axial load is applied, a spacer with large O.D. and small inner chamfer must be used between the bearing and shaft shoulder to obtain a sufficient contact area.

- Remarks: 1. Plummer block housings are housings with oil seals, a plug and a grease nipple only.
 To make a complete unit, please order the corresponding bearing, adapter sleeve and locating rings shown in the table additionally.
 2. The masses in the table do not include the bearing, nut and locating rings but the bolts.
 3. H8, H13 and h13 in the table means tolerance classes specified in JIS B 0401.
 4. The tolerance of locating ring O.D. is h12, and D ~ -0.2 for the width.

5. The threads for plugs are PT1/8. SN205 does not have a drain holes.
 6. When one locating ring is used for fixed-end, the offset (X dimension) of bearing center from the center of the plummer block housing is a half of the locating ring width.
 7. ZF type oil seals are also available instead of GS type seals.
 8. SNxxx-C type housings for shaft diameters different from the dimensions d_b or d_c shown in the table can be custom ordered.
 9. Please specify number of bolt holes.
 10. The dimension Y indicates the distance from the bearing center to the outer side face of the nut.

Plummer Block Housings
 Flat Bottom Type SN2F, SN3F Series
 for Bearing with Cylindrical Bore
 Shaft Diameter: $\phi 0 \sim 95\text{mm}$

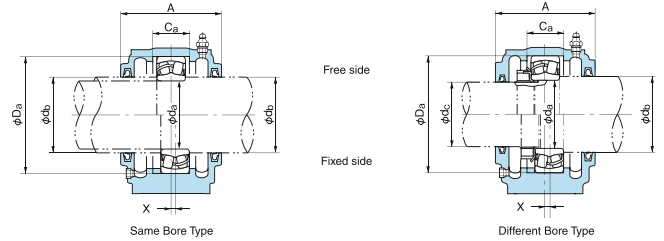
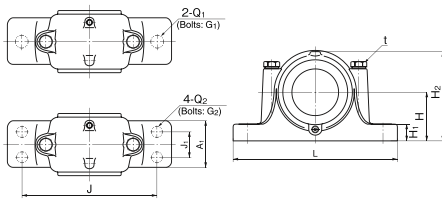

Shaft dia. (mm)	Dimensions (mm)													Bolt holes (Reference)						t (Nominal Reference)	Mass (kg) (Reference)	Designations		Applicable parts								Y (Reference)
	d_a	d_b	d_c	D_a (H8)	H (h13)	A	L	A_1	H_1	H_2	C_a (H13)	J	Q_1	G_1 (Nominal)	J_1	Q_2	G_2 (Nominal)	Same Bore Type	Different Bore Type			Self-aligning ball bearings	Spherical roller bearings	Nut	Locking washer	Oil seal d_b side	d_c side	Designations	Q'ty			
60	70	55	110	70	105	255	70	30	135	38	210	19	M16	35	15	M12	M12	6.9	SN212F	SN212FC	1212	—	AN12	AW12X	GS16	GS12	SR110×8	2	26			
	70(*)	55	130	80	125	280	80	30	155	56	230	19	M16	40	15	M12	M12	9.0	SN312F	SN312FC	2212	22212EX	AN12	AW12X	GS16	GS12	SR110×10	1	29			
65	75	60	120	80	110	275	80	30	150	43	230	19	M16	40	15	M12	M12	7.0	SN213F	SN213FC	1213	—	AN13	AW13X	GS17	GS13	SR120×10	2	28			
	75(*)	60	140	95	130	315	90	32	175	58	260	24	M20	50	19	M16	M16	13	SN313F	SN313FC	2213	22213EX	AN13	AW13X	GS17	GS13	SR120×12	1	32			
70	80	65	125	80	115	275	80	30	155	44	230	19	M16	40	15	M12	M12	7.6	SN214F	SN214FC	1214	—	AN14	AW14X	GS18	GS15	SR125×10	2	28			
	80(*)	65	150	95	130	320	90	32	185	61	260	24	M20	50	19	M16	M16	15	SN314F	SN314FC	2214	22214EX	AN14	AW14X	GS18	GS15	SR125×13	1	32			
75	85	70	130	80	115	280	80	30	155	41	230	19	M16	40	15	M12	M12	8.8	SN215F	SN215FC	1215	—	AN15	AW15X	GS19	GS16	SR130×8	2	30			
	85(*)	70	160	100	140	345	100	35	195	65	290	24	M20	50	19	M16	M16	16	SN315F	SN315FC	2215	22215EX	AN15	AW15X	GS19	GS16	SR130×10	1	33			
80	90	75	140	95	120	315	90	32	175	43	260	24	M20	50	19	M16	M16	13	SN216F	SN216FC	1216	—	AN16	AW16X	GS20	GS17	SR140×8.5	2	45			
	90(*)	75	170	112	145	345	100	35	212	68	290	24	M20	50	19	M16	M16	17	SN316F	SN316FC	2216	22216EX	AN16	AW16X	GS20	GS17	SR140×10	1	36			
85	95	80	150	95	125	320	90	32	185	46	260	24	M20	50	19	M16	M16	14	SN217F	SN217FC	1217	—	AN17	AW17X	GS21	GS18	SR150×9	2	34			
	95(*)	80	180	112	155	380	110	40	223	70	320	28	M24	60	24	M20	M20	24	SN317F	SN317FC	2217	22217EX	AN17	AW17X	GS21	GS18	SR150×10	1	38			
90	100	85	160	100	145	345	100	35	195	62.4	290	24	M20	50	19	M16	M16	18	SN218F	SN218FC	1218	—	AN18	AW18X	GS22	GS19	SR160×16.2	2	35			
	100(*)	85	190	112	165	390	110	40	235	75	330	28	M24	60	24	M20	M20	24	SN318F	SN318FC	2218	22218EX	AN18	AW18X	GS22	GS19	SR160×11.2	2	40			
95	110	90	170	112	140	345	100	35	210	53	290	24	M20	50	19	M16	M16	20	SN219F	SN219FC	1219	—	AN19	AW19X	GS24	GS20	SR170×10.5	2	37			
	110(*)	90	200	112	160	400	110	40	245	80	350	28	M24	60	24	M20	M20	24	SN319F	SN319FC	2219	22219EX	AN19	AW19X	GS24	GS20	SR170×10	1	43			

Note: (*) When heavy axial load is applied, a spacer with large O.D. and small inner chamfer must be used between the bearing and shaft shoulder to obtain a sufficient contact area.

Remarks: 1. Plummer block housings are housings with oil seals, a plug and a grease nipple only. To make a complete unit, please order the corresponding bearing, adapter sleeve and locating rings shown in the table additionally.

- The masses in the table do not include the bearing, nut and locating rings but the bolts.
- H8, H13 and h13 in the table means tolerance classes specified in JIS B 0401.
- The tolerance of locating ring O.D. is h12, and 0 ~ -0.2 for the width.

- Plummer block housings SN224F and larger are provided with eye bolts.
- The threads for plugs are PT1/8 for SN219F, SN316F and smaller, and PT1/4 for the others.
- When one locating ring is used for fixed-end, the offset (X dimension) of bearing center from the center of the plummer block housing is a half of the locating ring width.
- ZF type oil seals are also available instead of GS type seals.
- ShxxC type housings for shaft diameters different from the dimensions d_b or d_c shown in the table can be custom ordered.
- Please specify number of bolt holes.
- The dimension Y indicates the distance from the bearing center to the outer side face of the nut.

Plummer Block Housings
Flat Bottom Type SN2F, SN3F Series
for Bearing with Cylindrical Bore
 Shaft Diameter: 100~160mm

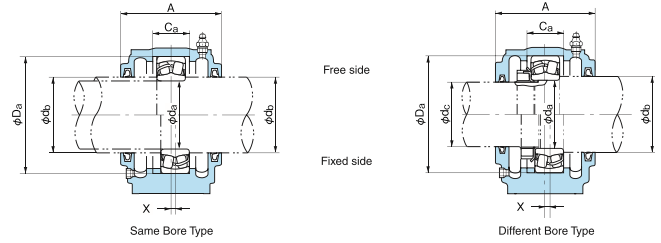
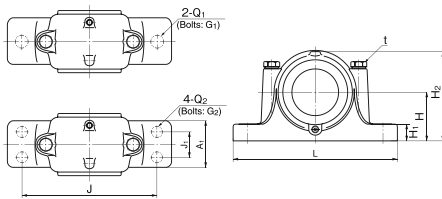

Shaft dia. (mm)	Dimensions (mm)											Bolt holes (Reference)						t (Nominal Reference)	Mass (kg) (Reference)	Designations		Applicable parts							Y (Reference)
	da	db	dc	D _a (H8)	H (h13)	A	L	A ₁	H ₁	H ₂	C _a (H13)	J	Q ₁	G ₁ (Nominal)	J ₁	Q ₂	G ₂ (Nominal)			Same Bore Type	Different Bore Type	Self-aligning ball bearings	Spherical roller bearings	Nut	Locking washer	Oil seal		Locating ring	
100	115	95	180	112	160	380	110	40	218	70.3	320	28	M24	60	24	M20	M20	26	SN220F	SN220FC	1220	—	AN20	AW20X	GS26	GS21	SR180 × 18.1	2	39
			—	—	—	—	—	—	—	—	—	—	—	—	—	—	—	—	—	—	—	2220	2222EX	—	—	—	—	SR180 × 12.1	2
110	125	105	200	125	175	410	120	45	240	80	350	28	M24	70	24	M20	M20	28	SN222F	SN222FC	—	—	AN22	AW22X	GS28	GS23	SR180 × 10	1	52
			—	—	—	—	—	—	—	—	—	—	—	—	—	—	—	—	—	—	—	1222	2222EX	—	—	—	—	SR200 × 21	2
120	135	115	215	140	185	410	120	45	270	86	350	28	M24	70	24	M20	M20	35	SN224F	SN224FC	—	—	AN24	AW24X	GS30	GS26	SR200 × 13.5	2	50
			—	—	—	—	—	—	—	—	—	—	—	—	—	—	—	—	—	—	—	2322E	2224EX	—	—	—	—	SR200 × 10	1
130	145	125	230	150	190	445	130	50	290	90	380	28	M24	70	28	M24	M24	42	SN226F	SN226FC	—	—	AN26	AW26	GS33	GS28	SR215 × 14	2	53
			—	—	—	—	—	—	—	—	—	—	—	—	—	—	—	—	—	—	—	2322E	2226EX	—	—	—	—	SR215 × 10	1
140	155	135	250	150	205	500	150	50	305	98	420	35	M30	80	28	M24	M24	52	SN228F	SN228FC	—	—	AN28	AW28	GS35	GS30	SR230 × 13	2	57
			—	—	—	—	—	—	—	—	—	—	—	—	—	—	—	—	—	—	—	2322E	2228EX	—	—	—	—	SR230 × 10	1
150	165	145	270	160	220	530	160	60	325	106	450	35	M30	90	28	M24	M24	61	SN230F	SN230FC	—	—	AN30	AW30	GS37	GS33	SR250 × 15	2	60
			—	—	—	—	—	—	—	—	—	—	—	—	—	—	—	—	—	—	—	2322E	2230EX	—	—	—	—	SR250 × 10	1
160	175	150	290	170	235	550	160	60	345	114	470	35	M30	90	28	M24	M24	68	SN232F	SN232FC	—	—	AN32	AW32	GS39	GS34	SR270 × 16.5	2	65
			—	—	—	—	—	—	—	—	—	—	—	—	—	—	—	—	—	—	—	2323E	2232EX	—	—	—	—	SR270 × 10	1
—	—	—	—	—	—	—	—	—	—	—	—	—	—	—	—	—	—	—	—	—	2323E	2323EX	—	—	—	—	SR290 × 17	2	71
—	—	—	—	—	—	—	—	—	—	—	—	—	—	—	—	—	—	—	—	—	—	—	—	—	—	SR290 × 10	1	83	

Remarks: 1. Plummer block housings are housings with oil seals, a plug and a grease nipple only. To make a complete unit, please order the corresponding bearing, adapter sleeve and locating rings shown in the table additionally.
 2. The masses in the table do not include the bearing, nut and locating rings but the bolts.
 3. H8, H13 and h13 in the table means tolerance classes specified in JIS B 0401.
 4. The tolerance of locating ring O.D. is h12, and 0 - -0.2 for the width.

5. Plummer block housings SN224F and larger are provided with eye bolts.
 6. The threads for plugs are PT1/8 for SN219F, SN316F and smaller, and PT1/4 for the others.
 7. When one locating ring is used for fixed-end, the offset (X dimension) of bearing center from the center of the plummer block housing is a half of the locating ring width.
 8. ZF type oil seals are also available instead of GS type seals.
 9. SNxxx-C type housings for shaft diameters different from the dimensions db or dc shown in the table can be custom ordered.
 10. Please specify number of bolt holes.
 11. The dimension Y indicates the distance from the bearing center to the outer side face of the nut.

Plummer Block Housings
SD5, SD6, SD30, SD31 Series
for Bearing with Adapter Sleeve
Shaft Diameter: 150~240mm

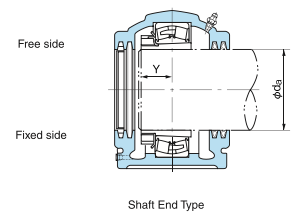
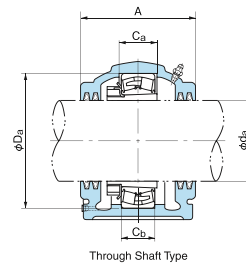
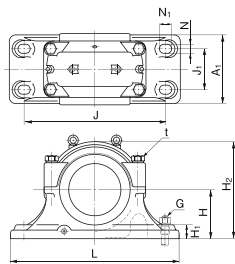

Shaft dia. da (mm)	Dimensions (mm)														Mass (kg) (Reference)	Designations		Applicable parts			Y (Reference)	
	Da (H8)	H (h13)	J	J1	N	N1	A	L	A1	H1	H2	Ca (H13)	Cb (H13)	G (Nominal)		t (Nominal)	Free side	Fixed side	Spherical roller bearings	Adapter sleeve		Oil seal
150	260	160	450	110	36	46	230	540	200	50	315	77	67	M30	M24	70	SD3034	SD3034G	23034EK	H3034	GS34	66
	280	170	470	120	36	46	250	560	220	50	335	98	88	M30	M24	75	SD3134	SD3134G	23134EK	H3134	GS34	76
	310	180	510	140	36	46	270	620	250	60	360	96	86	M30	M24	100	SD534	SD534G	22234EK	H3134	GS34	75
	360	210	610	170	36	46	300	740	290	65	420	130	120	M30	M30	160	SD634	SD634G	22334EK	H2334	GS34	92
160	280	170	470	120	36	46	250	560	220	50	335	84	74	M30	M24	79	SD3036	SD3036G	23036EK	H3036	GS36	70
	300	180	520	140	36	46	270	630	250	55	355	106	96	M30	M24	94	SD3136	SD3136G	23136EK	H3136	GS36	81
	320	190	540	150	36	46	280	650	260	60	380	96	86	M30	M24	110	SD536	SD536G	22236EK	H3136	GS36	76
	380	225	640	180	43	59	320	780	310	70	450	136	126	M36	M30	195	SD636	SD636G	22336EK	H2336	GS36	96
170	290	170	470	120	36	46	250	560	220	50	340	85	75	M30	M24	87	SD3038	SD3038G	23038EK	H3038	GS38	72
	320	190	560	140	36	46	290	680	270	55	385	114	104	M30	M24	110	SD3138	SD3138G	23138EK	H3138	GS38	86
	340	200	570	160	36	46	290	700	280	65	400	102	92	M30	M30	130	SD538	SD538G	22238EK	H3138	GS38	80
	400	240	680	190	43	59	330	820	320	70	475	142	132	M36	M30	210	SD638	SD638G	22338EK	H2338	GS38	100
180	310	180	510	140	36	46	270	620	250	60	360	92	82	M30	M24	100	SD3040	SD3040G	23040EK	H3040	GS40	76
	340	200	570	160	36	46	310	700	280	65	400	122	112	M30	M30	130	SD3140	SD3140G	23140EK	H3140	GS40	91
	360	210	610	170	36	46	300	740	290	65	420	108	98	M30	M30	155	SD540	SD540G	22240EK	H3140	GS40	84
	420	250	710	200	43	59	350	860	340	85	500	148	138	M36	M36	240	SD640	SD640G	22340EK	H2340	GS40	104
200	340	200	570	160	36	46	290	700	280	65	400	100	90	M30	M30	130	SD3044	SD3044G	23044EK	H3044	GS44	79
	370	225	640	180	43	59	320	780	310	70	445	130	120	M36	M30	180	SD3144	SD3144G	23144EK	H3144	GS44	96
	400	240	680	190	43	59	330	820	320	70	475	118	108	M36	M30	205	SD544	SD544G	22244EK	H3144	GS44	90
	460	280	770	210	43	59	360	920	350	85	550	155	145	M36	M36	315	SD644	SD644G	22344EK	H2344	GS44	109
220	360	210	610	170	36	46	300	740	290	65	420	102	92	M30	M30	160	SD3048	SD3048G	23048EK	H3048	GS48	84
	400	240	680	190	43	59	330	820	320	70	475	138	128	M36	M30	210	SD3148	SD3148G	23148EK	H3148	GS48	102
	440	260	740	200	43	59	340	880	330	85	515	130	120	M36	M36	240	SD548	SD548G	22248EK	H3148	GS48	98
	500	300	830	230	50	67	390	990	380	100	590	165	155	M42	M36	405	SD648	SD648G	22348EK	H2348	GS48	116
240	400	240	680	190	43	59	340	820	320	70	475	114	104	M36	M30	210	SD3052	SD3052G	23052EK	H3052	GS52	90
	440	260	740	200	43	59	360	880	350	85	515	154	144	M36	M36	240	SD3152	SD3152G	23152EK	H3152	GS52	112
	480	280	790	210	43	59	370	940	360	85	560	140	130	M36	M36	315	SD552	SD552G	22252EK	H3152	GS52	105
	540	325	890	250	50	67	410	1060	400	100	640	175	165	M42	M36	480	SD652	SD652G	22352EK	H2352	GS52	123

Remarks: 1. Plummer block housings are housings with oil seals, a plug and a grease nipple only.
To make a complete unit, please order the corresponding bearing, adapter sleeve and locating rings shown in the table additionally.
2. Dimension Ca is for the free side housings and dimension Cb for the fixed side housings. (Locating rings are not required in the fixed side housings.)
3. The masses in the table do not include the bearing and adapter sleeve but the bolts.
4. H8, H13 and h13 in the table means tolerance classes specified in JIS B 0401.
5. The thread for a grease nipple is PT1/4, and the threads for tow drain plugs are PT3/8.

6. Plummer block housings listed in the above table are provided with eye bolts.
7. Designations of shaft end type housings have suffix "E" at the end.
8. The dimension Y indicates the distance from the bearing center to the outer side face of the nut.

Plummer Block Housings
SD5, SD6, SD30, SD31 Series
for Bearing with Adapter Sleeve
 Shaft Diameter: 260~300mm

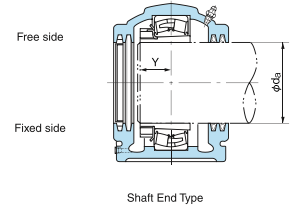
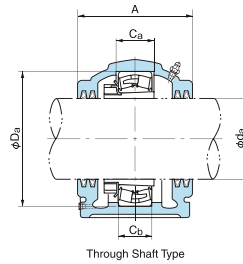
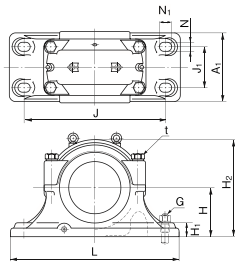

Shaft dia. da (mm)	Dimensions (mm)															Mass (kg) (Reference)	Designations		Applicable parts			Y (Reference)
	Da (H8)	H (h13)	J	J1	N	N1	A	L	A1	H1	H2	Ca (H13)	Cb (H13)	G (Nominal)	t (Nominal) (Reference)		Free side	Fixed side	Spherical roller bearings	Adapter sleeve	Oil seal	
260	420	250	710	200	43	59	350	860	340	85	500	116	106	M36	M36	240	SD3056	SD3056G	23056EK	H3056	GS56	95
	460	280	770	210	43	59	360	920	350	85	550	156	146	M36	M36	315	SD3156	SD3156G	23156EK	H3156	GS56	115
	500	300	830	230	50	67	390	990	380	100	590	140	130	M42	M36	390	SD556	SD556G	22256EK	H3156	GS56	107
	580	355	930	270	57	77	440	1110	430	110	690	185	175	M48	M42	610	SD656	SD656G	22356EK	H2356	GS56	130
280	460	280	770	210	43	59	360	920	350	85	550	128	118	M36	M36	300	SD3060	SD3060G	23060EK	H3060	GS60	105
	500	300	830	230	50	67	390	990	380	100	590	170	160	M42	M36	405	SD3160	SD3160G	23160EK	H3160	GS60	124
	540	325	890	250	50	67	410	1060	400	100	640	150	140	M42	M36	465	SD560	SD560G	22260EK	H3160	GS60	114
	480	280	790	210	43	59	380	940	360	85	560	131	121	M36	M36	320	SD3064	SD3064G	23064EK	H3064	GS64	108
300	540	325	890	250	50	67	430	1060	400	100	640	186	176	M42	M36	480	SD3164	SD3164G	23164EK	H3164	GS64	135
	580	355	930	270	57	77	440	1110	430	110	690	160	150	M48	M42	595	SD564	SD564G	22264EK	H3164	GS64	122

- Remarks: 1. Plummer block housings are housings with oil seals, a plug and a grease nipple only.
 To make a complete unit, please order the corresponding bearing, adapter sleeve and locating rings shown in the table additionally.
 2. Dimension Ca is for the free side housings and dimension Cb for the fixed side housings. (Locating rings are not required in the fixed side housings.)
 3. The masses in the table do not include the bearing and adapter sleeve but the bolts.
 4. H8, H13 and h13 in the table means tolerance classes specified in JIS B 0401.
 5. The thread for a grease nipple is PT1/4, and the threads for tow drain plugs are PT3/8.

6. Plummer block housings listed in the above table are provided with eye bolts.
 7. Designations of shaft end type housings have suffix "E" at the end.
 8. The dimension Y indicates the distance from the bearing center to the outer side face of the nut.

One piece type Plummer Block Housings
V Series
for Bearing with Adapter Sleeve
 Shaft Diameter: 30~60mm

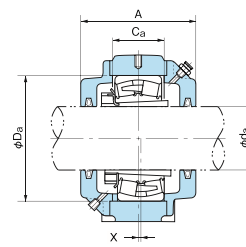
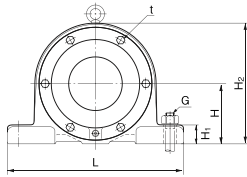
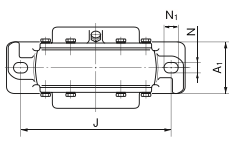

Through Shaft Type

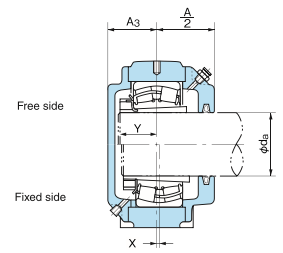

Free side

Fixed side

Shaft End Type

Shaft dia. da (mm)	Dimensions (mm)														Mass (kg) (Reference)	Designations		Applicable parts						
	D _a (H7)	H (h11)	J	N	N ₁	A	L	A ₁	A ₃	H ₁	H ₂	C _a	G (Nominal)	I (Nominal) (Reference)		Through Shaft Type	Shaft End Type	Self-aligning ball bearings	Spherical roller bearings	Adapter sleeve	Oil seal	Locating ring		Y (Reference)
																						Designations	Q'ty	
30	80	60	170	16	20	95	205	60	40.5	25	118	37	M14	M6	4.8	V080C30-30	V080C30-0	1307K 2307K	21307EK —	H307X H2307X	GS 7	SR80 × 8 SR80 × 6	2 1	21 26
	80	60	170	16	20	95	205	60	40.5	25	118	37	M14	M6	4.3	V080C35-35	V080C35-0	1208K 2208K	— 22208EXX	H208X H308X	GS 8	SR80 × 9.5 SR80 × 7	2 2	21 23
35	90	67	170	16	20	100	205	60	42.5	25	128	39	M14	M6	5.1	V090C35-35	V090C35-0	1308K 2308K	21308EK 22308EXX	H308X H2308X	GS 8	SR90 × 8 SR90 × 6	2 1	23 28
	85	63	170	16	20	98	205	60	42.5	25	125	39	M14	M6	4.7	V085C40-40	V085C40-0	1209K 2209K	— 22209EXX	H209X H309X	GS 9	SR85 × 10 SR85 × 8	2 2	22 24
40	100	71	210	16	23	106	255	70	47	28	140	42	M14	M6	6.9	V100C40-40	V100C40-0	1309K 2309K	21309EK 22309EXX	H309X H2309X	GS 9	SR100 × 9.5 SR100 × 6	2 1	25 31
	90	67	170	16	20	100	205	60	42.5	25	128	39	M14	M6	4.6	V090C45-45	V090C45-0	1210K 2210K	— 22210EXX	H210X H310X	GS10	SR90 × 9.5 SR90 × 8	2 2	24 25
45	110	80	210	21	25	112	255	70	47	30	155	46	M18	M6	8.9	V110C45-45	V110C45-0	1310K 2310K	21310EK 22310EXX	H310X H2310X	GS10	SR110 × 9.5 SR110 × 6	2 1	27 34
	100	71	210	16	23	106	255	70	47	28	140	42	M14	M6	6.4	V100C50-50	V100C50-0	1211K 2211K	— 22211EXX	H211X H311X	GS11	SR100 × 10.5 SR100 × 8.5	2 2	25 27
50	120	85	230	21	25	118	275	80	50	30	165	49	M18	M6	11	V120C50-50	V120C50-0	1311K 2311K	21311EK 22311EXX	H311X H2311X	GS11	SR120 × 10 SR120 × 6	2 1	29 36
	110	80	210	21	25	112	255	70	47	30	155	46	M18	M6	8.0	V110C55-55	V110C55-0	1212K 2212K	— 22212EXX	H212X H312X	GS12	SR110 × 12 SR110 × 9	2 2	26 29
55	130	90	230	21	25	118	280	80	50	30	175	50	M18	M6	12	V130C55-55	V130C55-0	1312K 2312K	21312EK 22312EXX	H312X H2312X	GS12	SR130 × 9.5 SR130 × 4	2 1	31 39
	120	85	230	21	25	118	275	80	50	30	165	49	M18	M6	10	V120C60-60	V120C60-0	1213K 2213K	— 22213EXX	H213X H313X	GS13	SR120 × 13 SR120 × 9	2 2	28 32
60	125	90	230	21	25	118	280	80	50	30	175	50	M18	M6	11	V125C60-60	V125C60-0	—	22214EXX	H314X	GS13	SR125 × 9.5	2	32
	140	100	260	25	30	136	315	90	58	32	195	56	M22	M8	18	V140C60-60	V140C60-0	1313K 2313K	21313EK 22313EXX	H313X H2313X	GS13	SR140 × 11.5 SR140 × 8	2 1	33 40
60	150	100	260	25	30	140	315	90	60	32	195	56	M22	M8	16	V150C60-60	V150C60-0	—	21314EK 22314EXX	H314X H2314X	GS13	SR150 × 10.5 SR150 × 5	2 1	34 42

Remarks: 1. Plummer block housings are housings with oil seals, a plug and a grease nipple only. To make a complete unit, please order the corresponding bearing, adapter sleeve and locating rings shown in the table additionally.
 2. The masses in the table do not include the bearing, adapter sleeve and locating rings.
 3. H7 and h11 in the table means tolerance classes specified in JIS B 0401.
 4. The tolerance of locating ring O.D. is h12, and 0 ~ -0.2 for the width.

5. Plummer block housings V180 and larger are provided with eye bolts.
 6. The threads for plugs and grease nipples are PT1/8 for V170 and smaller, and PT1/4 for V180 and larger.
 7. When one locating ring is used for fixed-end, the offset (X dimension) of bearing center from the center of the housing is a half of the locating ring width.
 8. ZF type oil seals are also available instead of GS type seals.
 9. The dimension Y indicates the distance from the bearing center to the outer side face of the nut.

One piece type Plummer Block Housings
V Series
for Bearing with Adapter Sleeve
 Shaft dia.: 65~90mm

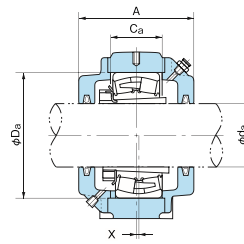
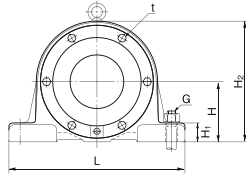
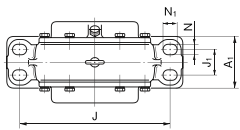

Through Shaft Type

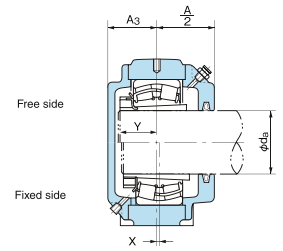

Shaft End Type

Shaft dia. da (mm)	Dimensions (mm)															Mass (kg) (Reference)	Designations		Applicable parts						
	Da (H7)	H (h11)	J	J1	N	N1	A	L	A1	A3	H1	H2	Ca	G (Nominal)	t (Nominal) (Reference)		Through Shaft Type	Shaft End Type	Self-aligning ball bearings	Spherical roller bearings	Adapter sleeve	Oil seal	Locating ring		Y (Reference)
																							Designations	Qty	
65	130	90	230	—	21	25	118	280	80	50	30	175	50	M18	M 6	11	V130C65-65	V130C65-0	1215K	—	H215X	GS15	SR130 x 12.5	2	30
	160	112	290	—	25	30	150	345	100	65	35	224	62	M22	M 8	24	V160C65-65	V160C65-0	2215K	22215EXK	H315X	GS15	SR130 x 9.5	2	33
																			1315K	21315EK	H315X		SR160 x 12.5	2	36
70	140	100	260	—	25	30	136	315	90	58	32	195	56	M22	M 8	17	V140C70-70	V140C70-0	2315K	22315EXK	H2315X	GS16	SR160 x 7	1	45
																			1216K	—	H216X		SR140 x 15	2	32
	170	112	290	—	25	30	165	345	100	72.5	35	224	62	M22	M 8	22	V170C70-70	V170C70-0	2216K	22216EXK	H316X	GS16	SR140 x 11.5	2	36
75	150	100	260	—	25	30	140	315	90	60	32	195	56	M22	M 8	16	V150C75-75	V150C75-0	1316K	21316EK	H316X	GS16	SR170 x 11.5	2	39
																			2316K	22316EXK	H2316X		SR170 x 4	1	48
	180	125	320	56	23	32	170	380	110	75	40	243	70	M20	M 8	29	V180C75-75	V180C75-0	1217K	—	H217X	GS17	SR150 x 14	2	34
80	160	112	290	—	25	30	150	345	100	65	35	224	62	M22	M 8	24	V160C80-80	V160C80-0	2217K	22217EXK	H317X	GS17	SR180 x 10	2	38
																			1317K	21317EK	H317X		SR180 x 14.5	2	41
	190	125	320	56	23	32	170	380	110	75	40	243	70	M20	M 8	26	V190C80-80	V190C80-0	2317K	22317EXK	H2317X	GS17	SR180 x 10	1	50
85	170	112	290	—	25	30	165	345	100	72.5	35	224	62	M22	M 8	22	V170C85-85	V170C85-0	1218K	—	H218X	GS18	SR160 x 16	2	35
																			2218K	22218EXK	H318X		SR160 x 11	2	40
	200	132	350	60	23	32	190	410	120	82	45	265	82	M20	M10	40	V190C85-85	V190C85-0	1318K	21318EK	H318X	GS18	SR190 x 13.5	2	42
90	180	125	320	56	23	32	170	380	110	75	40	243	70	M20	M 8	28	V180C90-90	V180C90-0	2318K	22318EXK	H2318X	GS19	SR190 x 6	1	52
																			1219K	—	H219X		SR170 x 15	2	37
	215	140	350	60	23	32	190	410	120	82	45	280	82	M20	M10	42	V200C90-90	V200C90-0	2219K	22219EXK	H319X	GS19	SR170 x 9.5	2	43
90	180	125	320	56	23	32	170	380	110	75	40	243	70	M20	M 8	28	V180C90-90	V180C90-0	1319K	21319EK	H319X	GS19	SR200 x 18.5	2	44
																			2319K	22319EXK	H2319X		SR200 x 15	1	55
	220K	—	H220X	GS20	SR180 x 18	2	39																		
1320K	22220EXK	H320X	GS20	SR180 x 12	2	45																			
2320K	22320EXK	H2320X		SR215 x 17.5	2	46																			

Remarks: 1. Plummer block housings are housings with oil seals, a plug and a grease nipple only. To make a complete unit, please order the corresponding bearing, adapter sleeve and locating rings shown in the table additionally.
 2. The masses in the table do not include the bearing, adapter sleeve and locating rings.
 3. H7 and h11 in the table means tolerance classes specified in JIS B 0401.
 4. The tolerance of locating ring O.D. is h12, and 0 ~ -0.2 for the width.

5. Plummer block housings V180 and larger are provided with eye bolts.
 6. The threads for plugs and grease nipples are PT1/8 for V170 and smaller, and PT1/4 for V180 and larger.
 7. When one locating ring is used for fixed-end, the offset (X dimension) of bearing center from the center of the housing is a half of the locating ring width.
 8. ZF type oil seals are also available instead of GS type seals.
 9. The dimension Y indicates the distance from the bearing center to the outer side face of the nut.

One piece type Plummer Block Housings
V Series
for Bearing with Adapter Sleeve
 Shaft Diameter: 100~135mm

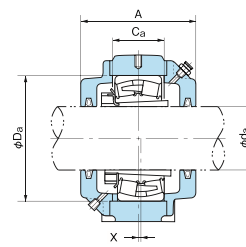
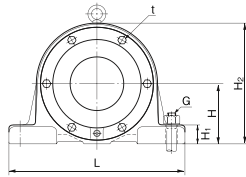
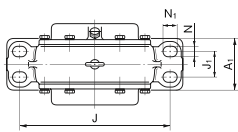

Through Shaft Type

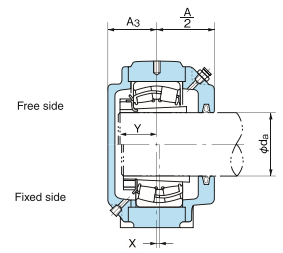

Free side

Fixed side

Shaft End Type

Shaft dia. da (mm)	Dimensions (mm)															Mass (kg) (Reference)	Designations		Applicable parts						
	Da (H7)	H (h11)	J	J1	N	N1	A	L	A1	A3	H1	H2	Ca	G (Nominal)	t (Nominal) (Reference)		Through Shaft Type	Shaft End Type	Self-aligning ball bearings	Spherical roller bearings	Adapter sleeve	Oil seal	Locating ring		Y (Reference)
																							Designations	Qty	
100	170	112	290	—	25	30	165	345	100	72.5	35	224	62	M22	M 8	20	V170C100-100	V170C100-0	—	23022EK	H322X	GS22	SR170 x 8.5	2	46
	180	125	320	56	23	32	170	380	110	75	40	243	70	M20	M 8	26	V180C100-100	V180C100-0	—	23122EK	H3122X	GS22	SR180 x 14	1	51
	200	132	350	60	23	32	190	410	120	82	45	265	82	M20	M10	39	V200C100-100	V200C100-0	1222K 2222K	— 22222EXX	H222X H322X	GS22	SR200 x 22	2	42
	240	160	390	80	23	32	218	470	150	96	50	315	96	M20	M10	60	V240C100-100	V240C100-0	1322K 2322K	21322EK 23222EXX	H322X H2322X	GS22	SR200 x 14.5 SR200 x 12.2 SR240 x 23 SR240 x 16	2 1 2 1	50 58 48 63
110	180	125	320	56	23	32	170	380	110	75	40	243	70	M20	M 8	25	V180C110-110	V180C110-0	—	23024EK	H3024X	GS24	SR180 x 12	2	47
	200	132	350	60	23	32	190	410	120	82	45	265	82	M20	M10	39	V200C110-110	V200C110-0	—	23124EK	H3124X	GS24	SR200 x 20	1	55
	215	140	350	60	23	32	190	410	120	82	45	280	82	M20	M10	41	V215C110-110	V215C110-0	—	22224EXX	H3124X	GS24	SR215 x 12	2	53
	260	170	450	92	29	42	236	540	160	105	60	335	103	M24	M10	72	V260C110-110	V260C110-0	—	23224EK	H2324X	GS24	SR215 x 6 SR260 x 17	1 1	62 67
115	200	132	350	60	23	32	190	410	120	82	45	265	82	M20	M10	38	V200C115-115	V200C115-0	—	23026EK	H3026	GS26	SR200 x 15	2	51
	210	140	350	60	23	32	190	410	120	82	45	280	82	M20	M10	42	V210C115-115	V210C115-0	—	23126EK	H3126	GS26	SR210 x 18	1	57
	230	150	380	65	23	32	200	450	130	87	50	300	86	M20	M10	50	V230C115-115	V230C115-0	—	22226EXX	H3126	GS26	SR230 x 11 SR230 x 6	2 1	57 65
	280	180	470	92	29	42	243	560	160	108.5	60	355	108	M24	M10	82	V280C115-115	V280C115-0	—	23226EK	H2326	GS26	SR280 x 15	1	72
125	210	140	350	60	23	32	190	410	120	82	45	280	82	M20	M10	40	V210C125-125	V210C125-0	—	23028EK	H3028	GS28	SR210 x 14.5	2	53
	225	150	380	65	23	32	200	450	130	87	50	300	86	M20	M10	50	V225C125-125	V225C125-0	—	23128EK	H3128	GS28	SR225 x 18	1	60
	250	160	420	80	23	32	218	500	150	96	50	315	94	M20	M10	54	V250C125-125	V250C125-0	—	22228EXX	H3128	GS28	SR250 x 13 SR250 x 6	2 1	60 70
	300	190	520	92	29	50	250	610	170	112	65	375	113	M24	M12	97	V300C125-125	V300C125-0	—	23228EK	H2328	GS28	SR300 x 11	1	77
135	225	150	380	65	23	32	200	450	130	87	50	300	86	M20	M10	50	V225C135-135	V225C135-0	—	23030EK	H3030	GS30	SR225 x 15	2	56
	250	160	420	80	23	32	218	500	150	96	50	315	94	M20	M10	52	V250C135-135	V250C135-0	—	23130EK	H3130	GS30	SR250 x 14	1	68
	270	170	450	92	29	42	236	540	160	105	60	335	103	M24	M10	64	V270C135-135	V270C135-0	—	22230EK	H2330	GS30	SR270 x 15 SR270 x 7	2 1	65 76
	320	200	560	92	29	50	258	660	180	116	65	405	122	M24	M12	128	V320C135-135	V320C135-0	—	22330EK	H2330	GS30	SR320 x 14	1	82

Remarks: 1. Plummer block housings are housings with oil seals, a plug and a grease nipple only.
 2. To make a complete unit, please order the corresponding bearing, adapter sleeve and locating rings shown in the table additionally.
 3. The masses in the table do not include the bearing, adapter sleeve and locating rings.
 4. H7 and h11 in the table means tolerance classes specified in JIS B 0401.
 5. The tolerance of locating ring O.D. is h12, and 0 ~ -0.2 for the width.

5. Plummer block housings V180 and larger are provided with eye bolts.
 6. The threads for plugs and grease nipples are PT1/8 for V170 and smaller, and PT1/4 for V180 and larger.
 7. When one locating ring is used for fixed-end, the offset (X dimension) of bearing center from the center of the housing is a half of the locating ring width.
 8. ZF type oil seals are also available instead of GS type seals.
 9. The dimension Y indicates the distance from the bearing center to the outer side face of the nut.

One piece type Plummer Block Housings
V Series
 for Bearing with Adapter Sleeve
 Shaft Diameter: 140~200mm

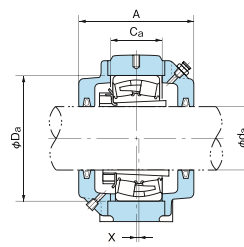
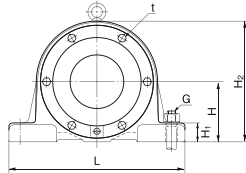
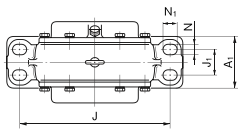

Through Shaft Type

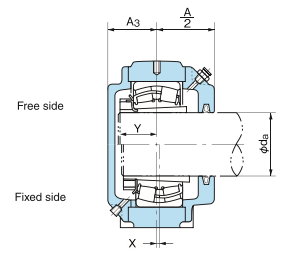

Free side

Fixed side

Shaft End Type

Shaft dia. da (mm)	Dimensions (mm)															Mass (kg) (Reference)	Designations		Applicable parts					Y (Reference)
	D _a (H7)	H (h11)	J	J ₁	N	N ₁	A	L	A ₁	A ₃	H ₁	H ₂	C _a	G (Nominal)	l (Nominal)		Through Shaft Type	Shaft End Type	Spherical roller bearings	Adapter sleeve	Oil seal	Locating ring		
																							Designations	
140	240	160	390	80	23	32	218	470	150	96	50	315	96	M20	M10	57	V240C140-140	V240C140-0	23032EK	H3032	GS32	SR240 × 18	2	61
	270	170	450	92	29	42	236	540	160	105	60	335	103	M24	M10	60	V270C140-140	V270C140-0	23132EK	H3132	GS32	SR270 × 17	1	74
	290	190	470	92	29	50	250	560	170	112	60	375	113	M24	M12	100	V290C140-140	V290C140-0	22232EK	H3132	GS32	SR290 × 16.5	2	71
150																	V290C140-140	V290C140-0	23232EK	H2332	GS32	SR290 × 9	1	83
	340	212	580	104	33	54	300	680	190	137	65	425	130	M27	M12	143	V340C140-140	V340C140-0	22332EK	H2332	GS32	SR340 × 16	1	88
	260	170	450	92	29	42	236	540	160	105	60	335	103	M24	M10	69	V260C150-150	V260C150-0	23034EK	H3034	GS34	SR260 × 18	2	66
	280	180	470	92	29	42	243	560	160	108.5	60	355	108	M24	M10	80	V280C150-150	V280C150-0	23134EK	H3134	GS34	SR280 × 20	1	76
160	310	200	560	92	29	50	258	660	180	116	65	405	122	M24	M12	120	V310C150-150	V310C150-0	22234EK	H3134	GS34	SR310 × 18	2	75
																	V310C150-150	V310C150-0	23234EK	H2334	GS34	SR310 × 12	1	87
	280	180	470	92	29	42	243	560	160	108.5	60	355	108	M24	M10	79	V280C160-160	V280C160-0	23036EK	H3036	GS36	SR280 × 17	2	70
170	300	190	520	92	29	50	250	610	170	112	65	375	113	M24	M12	95	V300C160-160	V300C160-0	23136EK	H3136	GS36	SR300 × 17	1	81
	320	200	560	92	29	50	258	660	180	116	65	405	122	M24	M12	115	V320C160-160	V320C160-0	22236EK	H3136	GS36	SR320 × 18	2	76
																	V320C160-160	V320C160-0	23236EK	H2336	GS36	SR320 × 10	1	89
180	290	190	470	92	29	50	250	560	170	112	60	375	113	M24	M12	94	V290C170-170	V290C170-0	23038EK	H3038	GS38	SR290 × 19	2	72
	320	200	560	92	29	50	258	660	180	116	65	405	122	M24	M12	124	V320C170-170	V320C170-0	23138EK	H3138	GS38	SR320 × 18	1	86
	340	212	580	104	33	54	300	680	190	137	65	425	130	M27	M12	140	V340C170-170	V340C170-0	22238EK	H3138	GS38	SR340 × 19	2	80
200																	V340C170-170	V340C170-0	23238EK	H2338	GS38	SR340 × 10	1	94
	310	200	560	92	29	50	258	660	180	116	65	405	122	M24	M12	117	V310C180-180	V310C180-0	23040EK	H3040	GS40	SR310 × 20	2	76
	340	212	580	104	33	54	300	680	190	137	65	425	130	M27	M12	138	V340C180-180	V340C180-0	23140EK	H3140	GS40	SR340 × 18	1	91
																	V340C200-200	V340C200-0	23044EK	H3044	GS44	SR340 × 20	2	79

Remarks: 1. Plummer block housings are housings with oil seals, a plug and a grease nipple only.
 To make a complete unit, please order the corresponding bearing, adapter sleeve and locating rings shown in the table additionally.
 2. The masses in the table do not include the bearing, adapter sleeve and locating rings.
 3. H7 and h11 in the table means tolerance classes specified in JIS B 0401.
 4. The tolerance of locating ring O.D. is h12, and 0 - -0.2 for the width.

5. Plummer block housings V180 and larger are provided with eye bolts.
 6. The threads for plugs and grease nipples are PT1/8 for V170 and smaller, and PT1/4 for V180 and larger.
 7. When one locating ring is used for fixed-end, the offset (X dimension) of bearing center from the center of the housing is a half of the locating ring width.
 8. ZF type oil seals are also available instead of GS type seals.
 9. The dimension Y indicates the distance from the bearing center to the outer side face of the nut.

One piece type Plummer Block Housings
V Series
 for Bearing with Cylindrical Bore
 Shaft Diameter: 35~70mm

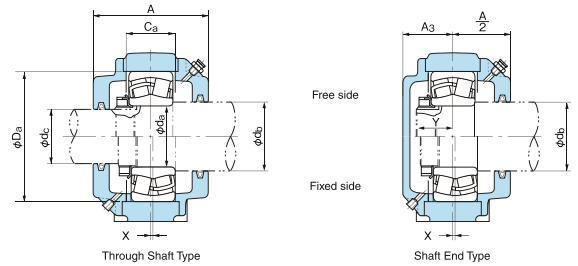
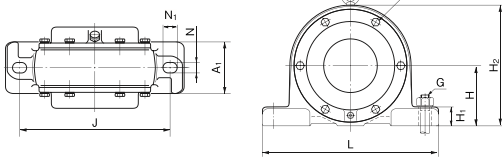

Shaft dia. (mm)		Dimensions (mm)														Mass (kg) (Reference)	Designations		Applicable parts							Y (Reference)		
ds	db	dc	Da (H7)	H (h11)	J	N	N1	A	L	A1	A3	H1	H2	Cs	G (Nominal) (Reference)		t (Nominal) (Reference)	Through Shaft Type	Shaft End Type	Self-aligning ball bearings	Spherical roller bearings	Nut	Locking washer	Oil seal	Locating ring			
																							db side	dc side	Designations	Q'ty		
35	45	30	80	60	170	16	20	95	205	60	40.5	25	118	37	M14	M6	4.5	V080C45-30	V080C45-0	1307 2307	21307E —	AN07	AW07X	GS10	GS 7	SR80×8 SR80×6	2 1	21 26
			80	60	170	16	20	95	205	60	40.5	25	118	37	M14	M6	4.0	V080C50-35	V080C50-0	1208 2208	— 22208EX	AN08	AW08X	GS11	GS 8	SR80×9.5 SR80×7	2 2	21 23
40	50	35	90	67	170	16	20	100	205	60	42.5	25	128	39	M14	M6	4.8	V090C50-35	V090C50-0	1308 2308	21308E 22308EX	AN08	AW08X	GS11	GS 8	SR90×8 SR90×6	2 1	23 28
			85	63	170	16	20	98	205	60	42.5	25	125	39	M14	M6	4.5	V085C55-40	V085C55-0	1209 2209	— 22209EX	AN09	AW09X	GS12	GS 9	SR85×10 SR85×8	2 2	22 24
45	55	40	100	71	210	16	23	106	255	70	47	28	140	42	M14	M6	6.4	V100C55-40	V100C55-0	1309 2309	21309E 22309EX	AN09	AW09X	GS12	GS 9	SR100×8.5 SR100×6	2 1	25 31
			90	67	170	16	20	100	205	60	42.5	25	128	39	M14	M6	4.3	V090C60-45	V090C60-0	1210 2210	— 22210EX	AN10	AW10X	GS13	GS10	SR90×9.5 SR90×8	2 2	24 25
50	60	45	110	80	210	21	25	112	255	70	47	30	155	46	M18	M6	7.8	V110C60-45	V110C60-0	1310 2310	21310E 22310EX	AN10	AW10X	GS13	GS10	SR110×9.5 SR110×6	2 1	27 34
			100	71	210	16	23	106	255	70	47	28	140	42	M14	M6	6.0	V100C65-50	V100C65-0	1211 2211	— 22211EX	AN11	AW11X	GS15	GS11	SR100×10.5 SR100×8.5	2 2	25 27
55	65	50	120	85	230	21	25	118	275	80	50	30	165	49	M18	M6	10	V120C65-50	V120C65-0	1311 2311	21311E 22311EX	AN11	AW11X	GS15	GS11	SR120×10 SR120×6	2 1	29 36
			110	80	210	21	25	112	255	70	47	30	155	46	M18	M6	7.6	V110C70-55	V110C70-0	1212 2212	— 22212EX	AN12	AW12X	GS16	GS12	SR110×12 SR110×9	2 2	26 29
60	70(1)	55	130	90	230	21	25	118	280	80	50	30	175	50	M18	M6	11	V130C70-55	V130C70-0	1312 2312	21312E 22312EX	AN12	AW12X	GS16	GS12	SR130×9.5 SR130×4	2 1	31 39
			75	60	120	85	230	21	25	118	275	80	50	30	165	49	M18	M6	9.6	V120C75-60	V120C75-0	1213 2213	— 22213EX	AN13	AW13X	GS17	GS13	SR120×13 SR120×9
65	75(1)	60	140	100	260	25	30	136	315	90	58	32	195	56	M22	M8	17	V140C75-60	V140C75-0	1313 2313	21313E 22313EX	AN13	AW13X	GS17	GS13	SR140×11.5 SR140×8	2 1	33 40
			80	60	125	90	230	21	25	118	280	80	50	30	175	50	M18	M6	10	V125C80-60	V125C80-0	1214 2214	— 22214EX	AN14	AW14X	GS18	GS13	SR125×13 SR125×9.5
70	80(1)	60	150	100	260	25	30	140	315	90	60	32	195	56	M22	M8	16	V150C80-60	V150C80-0	1314 2314	21314E 22314EX	AN14	AW14X	GS18	GS13	SR150×10.5 SR150×5	2 1	34 42

Note: (1) When heavy axial load is applied, a spacer with large O.D. and small inner chamfer must be used between the bearing and shaft shoulder to obtain a sufficient contact area.
 Remarks: 1. Plummer block housings are housings with oil seals, a plug and a grease nipple only.
 To make a complete unit, please order the corresponding bearing, nuts and locating rings shown in the table additionally.
 2. The masses in the table do not include the bearing, nuts and locating rings.
 3. H7 and h11 in the table means tolerance classes specified in JIS B 0401.
 4. The tolerance of locating ring O.D. is h12, and 0 ~ -0.2 for the width.

5. Plummer block housings V180 and larger are provided with eye bolts.
 6. The threads for plugs and grease nipples are PT1/8 for V170 and smaller, and PT1/4 for V180 and larger.
 7. When one locating ring is used for fixed-end, the offset (X dimension) of bearing center from the center of the housing is a half of the locating ring width.
 8. 2F type oil seals are also available instead of GS type seals.
 9. The dimension Y indicates the distance from the bearing center to the outer side face of the nut.

One piece type Plummer Block Housings
V Series
 for Bearing with Cylindrical Bore
 Shaft Diameter: 75~100mm

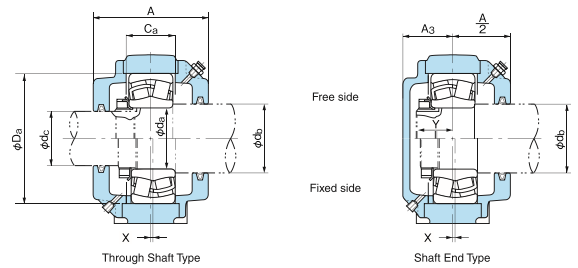
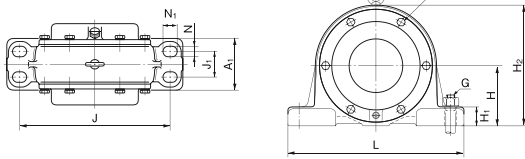

Shaft dia. (mm)		Dimensions (mm)																Mass (kg)	Designations		Applicable parts									
da	db	dc	D _a (H7)	H (h11)	J	J ₁	N	N ₁	A	L	A ₁	A ₂	H ₁	H ₂	Ca	G (Nominal)	l (Nominal)	(Reference)	Reference	Through Shaft Type	Shaft End Type	Self-aligning ball bearings	Spherical roller bearings	Nut	Locking washer	Oil seal	Locating ring		Y (Reference)	
																									db side	dc side	Designations	Q'ty		
75	85	65	130	90	230	—	21	25	118	280	80	50	30	175	50	M18	M	6	10	V130C85-65	V130C85-0	1215	—	AN15	AW15X	GS19	GS15	SR130×12.5	2	30
	85(*)	65	160	112	290	—	25	30	150	345	100	65	35	224	62	M22	M	8	23	V160C85-65	V160C85-0	2215	22215EX	AN15	AW15X	GS19	GS15	SR130×9.5	2	33
																						1315	21315E					SR160×12.5	2	36
																						2315	22315EX					SR160×7	1	45
80	90	70	140	100	260	—	25	30	136	315	90	58	32	195	56	M22	M	8	17	V140C90-70	V140C90-0	1216	—	AN16	AW16X	GS20	GS16	SR140×15	2	32
	90(*)	70	170	112	290	—	25	30	165	345	100	72.5	35	224	62	M22	M	8	21	V170C90-70	V170C90-0	2216	22216EX	AN16	AW16X	GS20	GS16	SR140×11.5	2	36
																						1316	21316E					SR170×11.5	2	39
																						2316	22316EX					SR170×4	1	48
85	95	75	150	100	260	—	25	30	140	315	90	60	32	195	56	M22	M	8	15	V150C95-75	V150C95-0	1217	—	AN17	AW17X	GS21	GS17	SR150×14	2	34
	95(*)	75	180	125	320	56	23	32	170	380	110	75	40	243	70	M20	M	8	28	V180C95-75	V180C95-0	2217	22217EX	AN17	AW17X	GS21	GS17	SR150×10	2	38
																						1317	21317E					SR180×14.5	2	41
																						2317	22317EX					SR180×10	1	50
90	100	80	160	112	290	—	25	30	150	345	100	65	35	224	62	M22	M	8	23	V160C100-80	V160C100-0	1218	—	AN18	AW18X	GS22	GS18	SR160×16	2	35
	100(*)	80	190	125	320	56	23	32	170	380	110	75	40	243	70	M20	M	8	25	V190C100-80	V190C100-0	2218	22218EX	AN18	AW18X	GS22	GS18	SR160×11	2	40
																						1318	21318E					SR190×13.5	2	42
																						2318	22318EX					SR190×6	1	52
95	110	85	170	112	290	—	25	30	165	345	100	72.5	35	224	62	M22	M	8	21	V170C110-85	V170C110-0	1219	—	AN19	AW19X	GS24	GS19	SR170×15	2	37
			200	132	350	60	23	32	190	410	120	82	45	265	82	M20	M	10	39	V200C110-85	V200C110-0	2219	22219EX	AN19	AW19X	GS24	GS19	SR170×9.5	2	43
																						1319	21319E					SR200×18.5	2	44
																						2319	22319EX					SR200×15	1	55
100	115	90	180	125	320	56	23	32	170	380	110	75	40	243	70	M20	M	8	27	V180C115-90	V180C115-0	1220	—	AN20	AW20X	GS26	GS20	SR180×18	2	39
			215	140	350	60	23	32	190	410	120	82	45	280	82	M20	M	10	40	V215C115-90	V215C115-0	2220	22220EX	AN20	AW20X	GS26	GS20	SR180×12	2	45
																						1320	21320E					SR215×17.5	2	46
																						2320	22320EX					SR215×9	1	59

Note: (*) When heavy axial load is applied, a spacer with large O.D. and small inner chamfer must be used between the bearing and shaft shoulder to obtain a sufficient contact area.
 Remarks: 1. Plummer block housings are housings with oil seals, a plug and a grease nipple only.
 To make a complete unit, please order the corresponding bearing, nuts and locating rings shown in the table additionally.
 2. The masses in the table do not include the bearing, nuts and locating rings.
 3. H7 and h11 in the table means tolerance classes specified in JIS B 0401.
 4. The tolerance of locating ring O.D. is h12, and 0 ~ -0.2 for the width.

5. Plummer block housings V180 and larger are provided with eye bolts.
 6. The threads for plugs and grease nipples are PT1/8 for V170 and smaller, and PT1/4 for V180 and larger.
 7. When one locating ring is used for fixed-end, the offset (X dimension) of bearing center from the center of the housing is a half of the locating ring width.
 8. ZF type oil seals are also available instead of GS type seals.
 9. The dimension Y indicates the distance from the bearing center to the outer side face of the nut.

One piece type Plummer Block Housings
V Series
 for Bearing with Cylindrical Bore
 Shaft Diameter: 170~220mm

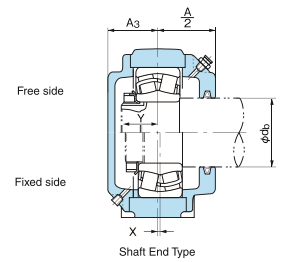
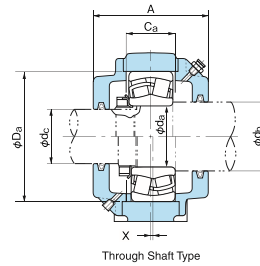
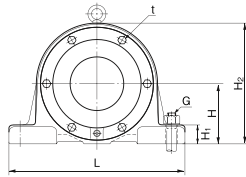
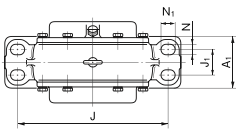

Shaft dia. (mm)		Dimensions (mm)															Mass (kg) (Reference)	Designations				Applicable parts						Y (Reference)
da	db	dc	D _a (H7)	H (h11)	J	J ₁	N	N ₁	A	L	A ₁	A ₃	H ₁	H ₂	Ca	G (Nominal)		l (Nominal)	Through Shaft Type	Shaft End Type	Spherical roller bearings	Nut	Locking washer	Oil seal		Locating ring		
																							db side	dc side	Designations	Q'ty		
170	180(*)	150	260	170	450	92	29	42	236	540	160	105	60	335	103	M24	M10	66	V260C180-150	V260C180-0	23034E	ANL34	AWL34	GS40	GS34	SR260 × 18	2	66
	190	150	280	180	470	92	29	42	243	560	160	108.5	60	355	108	M24	M10	78	V280C190-150	V280C190-0	23134E	AN34	AW34	GS42	GS34	SR280 × 20	1	76
			310	200	560	92	29	50	258	660	180	116	65	405	122	M24	M12	115	V310C190-150	V310C190-0	22234E	AN34	AW34	GS42	GS34	SR310 × 18	2	75
																					23234E					SR310 × 12	1	87
180	190(*)	160	280	180	470	92	29	42	243	560	160	108.5	60	355	108	M24	M10	78	V280C190-160	V280C190-0	23036E	ANL36	AWL36	GS42	GS36	SR280 × 17	2	70
	200	160	300	190	520	92	29	50	250	610	170	112	65	375	113	M24	M12	92	V300C200-160	V300C200-0	23136E	AN36	AW36	GS44	GS36	SR300 × 17	1	81
			320	200	560	92	29	50	258	660	180	116	65	405	122	M24	M12	110	V320C200-160	V320C200-0	22236E	AN36	AW36	GS44	GS36	SR320 × 18	2	76
																					23236E					SR320 × 10	1	89
190	200(*)	170	290	190	470	92	29	50	250	560	170	112	60	375	113	M24	M12	91	V290C200-170	V290C200-0	23038E	ANL38	AWL38	GS44	GS38	SR290 × 19	2	72
	210	170	320	200	560	92	29	50	258	660	180	116	65	405	122	M24	M12	120	V320C210-170	V320C210-0	23138E	AN38	AW38	GS46	GS38	SR320 × 18	1	86
			340	212	580	104	33	54	300	680	190	137	65	425	130	M27	M12	135	V340C210-170	V340C210-0	22238E	AN38	AW38	GS46	GS38	SR340 × 19	2	80
																					23238E					SR340 × 10	1	94
200	210(*)	180	310	200	560	92	29	50	258	660	180	116	65	405	122	M24	M12	125	V310C210-180	V310C210-0	23040E	ANL40	AWL40	GS46	GS40	SR310 × 20	2	76
	220	180	340	212	580	104	33	54	300	680	190	137	65	425	130	M27	M12	135	V340C220-180	V340C220-0	23140E	AN40	AW40	GS48	GS40	SR340 × 18	1	91
			340	212	580	104	33	54	300	680	190	137	65	425	130	M27	M12	132	V340C230-200	V340C230-0	23044E	ANL44	ALL44	GS50	GS44	SR340 × 20	2	79

Note: (*) When heavy axial load is applied, a spacer with large O.D. and small inner chamfer must be used between the bearing and shaft shoulder to obtain a sufficient contact area.

Remarks: 1. Plummer block housings are housings with oil seals, a plug and a grease nipple only.
 To make a complete unit, please order the corresponding bearing, nuts and locating rings shown in the table additionally.

- The masses in the table do not include the bearing, nuts and locating rings.
- H7 and h11 in the table means tolerance classes specified in JIS B 0401.
- The tolerance of locating ring O.D. is h12, and 0 -0.2 for the width.

- Plummer block housings V180 and larger are provided with eye bolts.
- The threads for plugs and grease nipples are PT1/8 for V170 and smaller, and PT1/4 for V180 and larger.
- When one locating ring is used for fixed-end, the offset (X dimension) of bearing center from the center of the housing is a half of the locating ring width.
- 2F type oil seals are also available instead of GS type seals.
- The dimension Y indicates the distance from the bearing center to the outer side face of the nut.



Mounting Accessories

- Adapter Assemblies
- Withdrawal Sleeves
- Locknuts
- Lockwashers
- Lock plates

Adapter Assemblies and Applied Bearing Bore Numbers

Bearing	Adapter Assembly series					
	H30	H31	H2	H32	H3	H23
Self-aligning Ball Bearings	12 K			04~22		
	22 K				04~22	
	13 K				04~22	
Spherical Roller Bearings	230 K	24~/500				04~22
	231 K		22~/500			
	222 K		24~64			05~22
	232 K			60~/500		18~56
	213 K				05~22	
	223 K					08~56
Ball Bearings for Bearing Units	UK2					05~18
	UKX					05~28
	UK3					05~20

Withdrawal Sleeves and Applied Bearing Bore Numbers

Bearing	Withdrawal Sleeve series						
	AH30	AH31	AH2	AH22	AH32	AH3	AH23
Self-aligning Ball Bearings	12 K		08~22				
	22 K		22				08~20
	13 K					08~22	
	23 K						08~22
Spherical Roller Bearings	230 K	24~/500					
	231 K		22~/500				
	222 K		22~34	36~64		08~20	
	232 K				18~40 60~/500		44~56
	213 K					08~22	
	223 K						08~56

Note: In case of spherical roller bearings without outer rib on inner ring, locknut may have a larger bore than the outside diameter of the inner ring. Please check the dimensions.

Adapter Assemblies
Series H30 / HE30

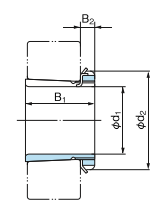

Adapter Ass'y with Lockwasher

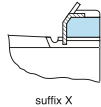

suffix X

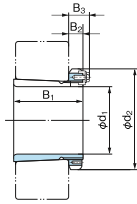

Adapter Ass'y with Lock Plate

Bearing bore No.	Dimensions (mm)						Mass ⁽¹⁾ (kg) (reference)	Adapter Ass'y No.		Part No.			
	H	HE	d ₂	B ₁	B ₂	B ₃		H	HE	Adapter ⁽²⁾ sleeve	Locknut	Lockwasher	Lock Plate
24	110	107.95	145	72	22	—	1.96	H3024X	HE3024X	A3024X	ANL 24	AWL 24X	—
26	115	114.30	155	80	23	—	2.85	H3026	HE3026	A3026	ANL 26	AWL 26	—
28	125	127.00	165	82	24	—	3.18	H3028	HE3028	A3028	ANL 28	AWL 28	—
30	135	133.35	180	87	26	—	3.90	H3030	HE3030	A3030	ANL 30	AWL 30	—
32	140	139.70	190	93	28	—	5.20	H3032	HE3032	A3032	ANL 32	AWL 32	—
34	150	152.40	200	101	29	—	6.00	H3034	HE3034	A3034	ANL 34	AWL 34	—
36	160	165.10	210	109	30	—	6.85	H3036	HE3036	A3036	ANL 36	AWL 36	—
38	170	171.45	220	112	31	—	7.45	H3038	HE3038	A3038	ANL 38	AWL 38	—
40	180	177.80	240	120	32	—	9.20	H3040	HE3040	A3040	ANL 40	AWL 40	—
44	200	—	260	128	30	41	10.3	H3044	—	A3044	ANL 44	—	ALL 44
48	220	—	290	133	34	46	13.4	H3048	—	A3048	ANL 48	—	ALL 48
52	240	—	310	145	34	46	15.6	H3052	—	A3052	ANL 52	—	ALL 48
56	260	—	330	152	38	50	17.7	H3056	—	A3056	ANL 56	—	ALL 56
60	280	—	360	168	42	54	22.8	H3060	—	A3060	ANL 60	—	ALL 60
64	300	—	380	171	42	55	24.6	H3064	—	A3064	ANL 64	—	ALL 64
68	320	—	400	187	45	58	28.6	H3068	—	A3068	ANL 68	—	ALL 64
72	340	—	420	188	45	58	30.6	H3072	—	A3072	ANL 72	—	ALL 72
76	360	—	450	193	48	62	35.8	H3076	—	A3076	ANL 76	—	ALL 76
80	380	—	470	210	52	66	42.1	H3080	—	A3080	ANL 80	—	ALL 76
84	400	—	490	212	52	66	44.3	H3084	—	A3084	ANL 84	—	ALL 84
88	410	—	520	228	60	77	67.0	H3088	—	A3088	ANL 88	—	ALL 88
92	430	—	540	234	60	77	71.5	H3092	—	A3092	ANL 92	—	ALL 88
96	450	—	560	237	60	77	75.2	H3096	—	A3096	ANL 96	—	ALL 96
/500	470	—	580	247	68	85	81.8	H30/500	—	A30/500	ANL100	—	ALL 96

Notes: ⁽¹⁾ The masses in the table are for H series.
⁽²⁾ The numbers in the table mean sleeves for H series.
 Sleeves for HE series have prefix AE instead of A.
 Remark: Suffix X means narrow axial slot type. For this type sleeves, only lockwashers with straight inner tab can be used.

Adapter Assemblies
Series H31 / HE31

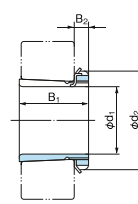

Adapter Ass'y with Lockwasher

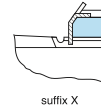

suffix X

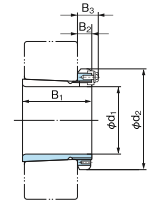

Adapter Ass'y with Lock Plate

Bearing bore No.	Dimensions (mm)						Mass ⁽¹⁾ (kg) (reference)	Adapter Ass'y No.		Part No.			
	H	HE	d ₂	B ₁	B ₂	B ₃		H	HE	Adapter ⁽²⁾ sleeve	Locknut	Lockwasher	Lock Plate
22	100	101.60	145	81	21	—	2.25	H3122X	HE3122X	A3122X	AN 22	AW 22X	—
24	110	107.95	155	88	22	—	2.64	H3124X	HE3124X	A3124X	AN 24	AW 24X	—
26	115	114.30	165	92	23	—	3.66	H3126	HE3126	A3126	AN 26	AW 26	—
28	125	127.00	180	97	24	—	4.34	H3128	HE3128	A3128	AN 28	AW 28	—
30	135	133.35	195	111	26	—	5.54	H3130	HE3130	A3130	AN 30	AW 30	—
32	140	139.70	210	119	28	—	7.70	H3132	HE3132	A3132	AN 32	AW 32	—
34	150	152.40	220	122	29	—	8.40	H3134	HE3134	A3134	AN 34	AW 34	—
36	160	165.10	230	131	30	—	9.50	H3136	HE3136	A3136	AN 36	AW 36	—
38	170	171.45	240	141	31	—	10.8	H3138	HE3138	A3138	AN 38	AW 38	—
40	180	177.80	250	150	32	—	12.1	H3140	HE3140	A3140	AN 40	AW 40	—
44	200	—	280	158	32	44	14.7	H3144	—	A3144	AN 44	—	AL 44
48	220	—	300	169	34	46	17.3	H3148	—	A3148	AN 48	—	AL 44
52	240	—	330	187	36	49	22.0	H3152	—	A3152	AN 52	—	AL 52
56	260	—	350	192	38	51	24.5	H3156	—	A3156	AN 56	—	AL 52
60	280	—	380	208	40	53	30.3	H3160	—	A3160	AN 60	—	AL 60
64	300	—	400	226	42	56	35.0	H3164	—	A3164	AN 64	—	AL 64
68	320	—	440	254	55	72	49.5	H3168	—	A3168	AN 68	—	AL 68
72	340	—	460	259	58	75	54.5	H3172	—	A3172	AN 72	—	AL 68
76	360	—	490	264	60	77	61.6	H3176	—	A3176	AN 76	—	AL 76
80	380	—	520	272	62	82	70.1	H3180	—	A3180	AN 80	—	AL 80
84	400	—	540	304	70	90	84.0	H3184	—	A3184	AN 84	—	AL 80
88	410	—	560	307	70	90	103	H3188	—	A3188	AN 88	—	AL 88
92	430	—	580	326	75	95	116	H3192	—	A3192	AN 92	—	AL 88
96	450	—	620	335	75	95	133	H3196	—	A3196	AN 96	—	AL 96
/500	470	—	630	356	80	100	143	H31/500	—	A31/500	AN100	—	AL 100

Notes: ⁽¹⁾ The masses in the table are for H series.
⁽²⁾ The numbers in the table mean sleeves for H series.
 Sleeves for HE series have prefix AE instead of A.
 Remark: Suffix X means narrow axial slot type. For this type sleeves, only lockwashers with straight inner tab can be used.

Adapter Assemblies
Series H2 / HE2 / HS2

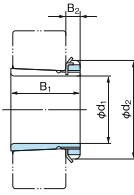

Bearing bore No.	Dimensions (mm)						Mass ⁽¹⁾ (kg) (reference)	Adapter Ass'y No.			Part No.		
	H	HE	HS	d ₂	B ₁	B ₂		H	HE	HS	Adapter sleeve ⁽²⁾	Locknut	Lockwasher
04	17	—	—	32	24	7	0.041	H204X	—	—	A204X	AN 04	AW 04X
05	20	19.050	—	38	26	8	0.070	H205X	HE205X	—	A205X	AN 05	AW 05X
06	25	25.400	22.225	45	27	8	0.099	H206X	HE206X	HS206X	A206X	AN 06	AW 06X
07	30	—	28.575	52	29	9	0.125	H207X	—	HS207X	A207X	AN 07	AW 07X
08	35	31.750	34.925	58	31	10	0.174	H208X	HE208X	HS208X	A208X	AN 08	AW 08X
09	40	38.100	—	65	33	11	0.226	H209X	HE209X	—	A209X	AN 09	AW 09X
10	45	44.450	41.275	70	35	12	0.274	H210X	HE210X	HS210X	A210X	AN 10	AW 10X
11	50	50.800	47.625	75	37	12	0.308	H211X	HE211X	HS211X	A211X	AN 11	AW 11X
12	55	—	53.975	80	38	13	0.346	H212X	—	HS212X	A212X	AN 12	AW 12X
13	60	57.150	60.325	85	40	14	0.401	H213X	HE213X	HS213X	A213X	AN 13	AW 13X
14	60	—	—	92	41	14	0.550	H214X	—	—	A214X	AN 14	AW 14X
15	65	63.500	66.675	98	43	15	0.708	H215X	HE215X	HS215X	A215X	AN 15	AW 15X
16	70	69.850	—	105	46	17	0.881	H216X	HE216X	—	A216X	AN 16	AW 16X
17	75	76.200	73.025	110	50	18	1.02	H217X	HE217X	HS217X	A217X	AN 17	AW 17X
18	80	—	79.375	120	52	18	1.18	H218X	—	HS218X	A218X	AN 18	AW 18X
19	85	82.550	85.725	125	55	19	1.37	H219X	HE219X	HS219X	A219X	AN 19	AW 19X
20	90	88.900	—	130	58	20	1.49	H220X	HE220X	—	A220X	AN 20	AW 20X
21	95	—	—	140	60	20	1.70	H221X	—	—	A221X	AN 21	AW 21X
22	100	101.600	—	145	63	21	1.93	H222X	HE222X	—	A222X	AN 22	AW 22X

Notes: ⁽¹⁾ The masses in the table are for H series.
⁽²⁾ The numbers in the table mean sleeves for H series.
Sleeves for HE or HS series have prefix AE or AS.

Remark: Suffix X means narrow axial slot type. For this type sleeves, only lockwashers with straight inner tab can be used.

Adapter Assemblies
Series H32

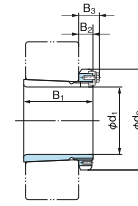

Bearing bore No.	Dimensions (mm)					Mass (kg) (reference)	Adapter Ass'y No.	Part No.		
	d ₁	d ₂	B ₁	B ₂	B ₃			Adapter sleeve	Locknut	Lockwasher
60	280	380	240	40	53	34.0	H3260	A3260	AN 60	AL 60
64	300	400	258	42	56	39.4	H3264	A3264	AN 64	AL 64
68	320	440	288	55	72	54.6	H3268	A3268	AN 68	AL 68
72	340	460	299	58	75	60.2	H3272	A3272	AN 72	AL 68
76	360	490	310	60	77	69.6	H3276	A3276	AN 76	AL 76
80	380	520	328	62	82	80.9	H3280	A3280	AN 80	AL 80
84	400	540	352	70	90	94.6	H3284	A3284	AN 84	AL 80
88	410	560	361	70	90	118	H3288	A3288	AN 88	AL 88
92	430	580	382	75	95	133	H3292	A3292	AN 92	AL 88
96	450	620	397	75	95	153	H3296	A3296	AN 96	AL 96
/500	470	630	428	80	100	166	H32/500	A32/500	AN100	AL100

**Adapter Assemblies
Series H3 / HE3 / HS3**

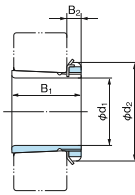

Bearing bore No.	Dimensions (mm)						Mass ⁽¹⁾ (kg) (reference)	Adapter Ass'y No.			Part No.		
	H	HE	HS	d ₂	B ₁	B ₂		H	HE	HS	Adapter ⁽²⁾ sleeve	Locknut	Lockwasher
04	17	—	—	32	28	7	0.045	H304X	—	—	A304X	AN 04	AW 04X
05	20	19.050	—	38	29	8	0.075	H305X	HE305X	—	A305X	AN 05	AW 05X
06	25	25.400	22.225	45	31	8	0.109	H306X	HE306X	HS306X	A306X	AN 06	AW 06X
07	30	—	28.575	52	35	9	0.142	H307X	—	HS307X	A307X	AN 07	AW 07X
08	35	31.750	34.925	58	36	10	0.189	H308X	HE308X	HS308X	A308X	AN 08	AW 08X
09	40	38.100	—	65	39	11	0.248	H309X	HE309X	—	A309X	AN 09	AW 09X
10	45	44.450	41.275	70	42	12	0.302	H310X	HE310X	HS310X	A310X	AN 10	AW 10X
11	50	50.800	47.625	75	45	12	0.345	H311X	HE311X	HS311X	A311X	AN 11	AW 11X
12	55	—	53.975	80	47	13	0.393	H312X	—	HS312X	A312X	AN 12	AW 12X
13	60	57.150	60.325	85	50	14	0.459	H313X	HE313X	HS313X	A313X	AN 13	AW 13X
14	60	—	—	92	52	14	0.723	H314X	—	—	A314X	AN 14	AW 14X
15	65	63.500	66.675	98	55	15	0.830	H315X	HE315X	HS315X	A315X	AN 15	AW 15X
16	70	69.850	—	105	59	17	1.03	H316X	HE316X	—	A316X	AN 16	AW 16X
17	75	76.200	73.025	110	63	18	1.18	H317X	HE317X	HS317X	A317X	AN 17	AW 17X
18	80	—	79.375	120	65	18	1.37	H318X	—	HS318X	A318X	AN 18	AW 18X
19	85	82.550	85.725	125	68	19	1.56	H319X	HE319X	HS319X	A319X	AN 19	AW 19X
20	90	88.900	—	130	71	20	1.69	H320X	HE320X	—	A320X	AN 20	AW 20X
21	95	—	—	140	74	20	1.93	H321X	—	—	A321X	AN 21	AW 21X
22	100	101.600	—	145	77	21	2.18	H322X	HE322X	—	A322X	AN 22	AW 22X

Notes: ⁽¹⁾ The masses in the table are for H series.
⁽²⁾ The numbers in the table mean sleeves for H series.
 Sleeves for HE or HS series have prefix AE or AS.
 Remark: Suffix X means narrow axial slot type. For this type sleeves, only lockwashers with straight inner tab can be used.

**Adapter Assemblies
Series H23 / HE23**

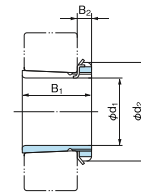

Adapter Ass'y with Lockwasher

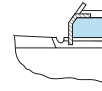

suffix X

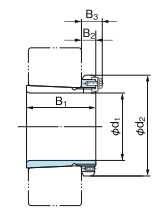

Adapter Ass'y with Lock Plate

Bearing bore No.	Dimensions (mm)						Mass ⁽¹⁾ (kg) (reference)	Adapter Ass'y No.			Part No.		
	H	HE	d ₂	B ₁	B ₂	B ₃		H	HE	Adapter ⁽²⁾ sleeve	Locknut	Lockwasher	Lock Plate
04	17	—	32	31	7	—	0.049	H2304X	—	A2304X	AN 04	AW 04X	—
05	20	19.05	38	35	8	—	0.087	H2305X	HE2305X	A2305X	AN 05	AW 05X	—
06	25	25.40	45	38	8	—	0.126	H2306X	HE2306X	A2306X	AN 06	AW 06X	—
07	30	—	52	43	9	—	0.165	H2307X	—	A2307X	AN 07	AW 07X	—
08	35	31.75	58	46	10	—	0.224	H2308X	HE2308X	A2308X	AN 08	AW 08X	—
09	40	38.10	65	50	11	—	0.280	H2309X	HE2309X	A2309X	AN 09	AW 09X	—
10	45	44.45	70	55	12	—	0.362	H2310X	HE2310X	A2310X	AN 10	AW 10X	—
11	50	50.80	75	59	12	—	0.420	H2311X	HE2311X	A2311X	AN 11	AW 11X	—
12	55	—	80	62	13	—	0.480	H2312X	—	A2312X	AN 12	AW 12X	—
13	60	57.15	85	65	14	—	0.556	H2313X	HE2313X	A2313X	AN 13	AW 13X	—
14	60	—	92	68	14	—	0.897	H2314X	—	A2314X	AN 14	AW 14X	—
15	65	63.50	98	73	15	—	1.05	H2315X	HE2315X	A2315X	AN 15	AW 15X	—
16	70	69.85	105	78	17	—	1.28	H2316X	HE2316X	A2316X	AN 16	AW 16X	—
17	75	76.20	110	82	18	—	1.45	H2317X	HE2317X	A2317X	AN 17	AW 17X	—
18	80	—	120	86	18	—	1.70	H2318X	—	A2318X	AN 18	AW 18X	—
19	85	82.55	125	90	19	—	1.94	H2319X	HE2319X	A2319X	AN 19	AW 19X	—
20	90	88.90	130	97	20	—	2.15	H2320X	HE2320X	A2320X	AN 20	AW 20X	—
21	95	—	140	101	20	—	2.45	H2321X	—	A2321X	AN 21	AW 21X	—
22	100	101.60	145	105	21	—	2.74	H2322X	HE2322X	A2322X	AN 22	AW 22X	—
24	110	107.95	155	112	22	—	3.20	H2324X	HE2324X	A2324X	AN 24	AW 24X	—
26	115	114.30	165	121	23	—	4.60	H2326	HE2326	A2326	AN 26	AW 26	—
28	125	127.00	180	131	24	—	5.52	H2328	HE2328	A2328	AN 28	AW 28	—
30	135	133.35	195	139	26	—	6.60	H2330	HE2330	A2330	AN 30	AW 30	—
32	140	139.70	210	147	28	—	9.15	H2332	HE2332	A2332	AN 32	AW 32	—
34	150	152.40	220	154	29	—	10.4	H2334	HE2334	A2334	AN 34	AW 34	—
36	160	165.10	230	161	30	—	11.3	H2336	HE2336	A2336	AN 36	AW 36	—
38	170	171.45	240	169	31	—	12.6	H2338	HE2338	A2338	AN 38	AW 38	—
40	180	177.80	250	176	32	—	13.9	H2340	HE2340	A2340	AN 40	AW 40	—
44	200	—	280	183	32	44	16.6	H2344	—	A2344	AN 44	—	AL 44
48	220	—	300	196	34	46	19.7	H2348	—	A2348	AN 48	—	AL 44
52	240	—	330	208	36	49	24.2	H2352	—	A2352	AN 52	—	AL 52
56	260	—	350	221	38	51	27.8	H2356	—	A2356	AN 56	—	AL 52

Notes: ⁽¹⁾ The masses in the table are for H series.
⁽²⁾ The numbers in the table mean sleeves for H series.
 Sleeves for HE series have prefix AE instead of A.
 Remarks: 1. Suffix X means narrow axial slot type. For this type sleeves, only lockwashers with straight inner tab can be used.
 2. In-core bore type HS series is also available.

Withdrawal Sleeves
Series AH30 / AHX30

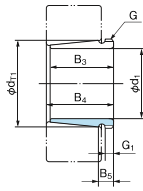

Bearing bore No.	Thread Nominal G	Dimensions (mm)						Mass (kg) (reference)	Withdrawal Sleeve No.	Locknut No.
		d1	B3	B4	dT1	B5	G1			
24	M 130×2	115	60	64	124.00	16	13	0.75	AHX3024	AN 26
26	M 140×2	125	67	71	134.50	17	14	0.93	AHX3026	AN 28
28	M 150×2	135	68	73	144.67	17	14	1.01	AHX3028	AN 30
30	M 160×3	145	72	77	154.92	18	15	1.15	AHX3030	AN 32
32	M 170×3	150	77	82	165.25	19	16	2.10	AH 3032	AN 34
34	M 180×3	160	85	90	175.83	20	17	2.50	AH 3034	AN 36
36	M 190×3	170	92	98	186.08	25	17	2.90	AH 3036	AN 38
38	Tr 205×4	180	96	102	196.50	24	18	3.40	AH 3038	HNL 41
40	Tr 215×4	190	102	108	206.92	25	19	3.80	AH 3040	HNL 43
44	Tr 235×4	200	111	117	227.58	26	20	7.40	AH 3044	HNL 47
48	Tr 260×4	220	116	123	248.00	27	21	8.80	AH 3048	HNL 52
52	Tr 280×4	240	128	135	268.83	29	23	10.7	AH 3052	HNL 56
56	Tr 300×4	260	131	139	289.08	30	24	12.0	AH 3056	HNL 60
60	Tr 320×5	280	145	153	310.08	32	26	14.4	AH 3060	HNL 64
64	Tr 345×5	300	149	157	330.33	33	27	16.0	AH 3064	HNL 69
68	Tr 365×5	320	162	171	351.42	34	28	19.5	AH 3068	HNL 73
72	Tr 385×5	340	167	176	371.67	36	30	21.0	AH 3072	HNL 77
76	Tr 410×5	360	170	180	391.92	37	31	23.5	AH 3076	HNL 82
80	Tr 430×5	380	183	193	412.83	39	33	27.2	AH 3080	HNL 86
84	Tr 450×5	400	186	196	433.00	40	34	29.1	AH 3084	HNL 90
88	Tr 470×5	420	194	205	453.67	41	35	32.1	AHX3088	HNL 94
92	Tr 490×5	440	202	213	474.17	43	37	35.3	AHX3092	HNL 98
96	Tr 520×6	460	205	217	494.42	44	38	40.0	AHX3096	HNL104
/500	Tr 540×6	480	209	221	514.58	46	40	42.5	AHX30/500	HNL108

Withdrawal Sleeves
Series AH30 / AHX30

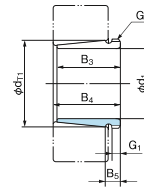

Bearing bore No.	Thread Nominal G	Dimensions (mm)						Mass (kg) (reference)	Withdrawal Sleeve No.	Locknut No.
		d1	B3	B4	dT1	B5	G1			
22	M 120×2	105	68	72	114.83	14	11	0.76	AHX3122	AN 24
24	M 130×2	115	75	79	125.33	15	12	0.95	AHX3124	AN 26
26	M 140×2	125	78	82	135.58	15	12	1.08	AHX3126	AN 28
28	M 150×2	135	83	88	145.92	17	14	1.28	AHX3128	AN 30
30	M 165×3	145	96	101	156.92	18	15	1.79	AHX3130	AN 33
32	M 180×3	150	103	108	167.42	19	16	3.20	AH 3132	AN 36
34	M 190×3	160	104	109	177.50	19	16	3.50	AH 3134	AN 38
36	M 200×3	170	116	122	188.33	22	19	4.20	AH 3136	AN 40
38	Tr 210×4	180	125	131	198.75	26	20	4.90	AH 3138	HN 42
40	Tr 220×4	190	134	140	209.42	27	21	5.60	AH 3140	HN 44
44	Tr 240×4	200	145	151	230.17	29	23	10.4	AH 3144	HN 48
48	Tr 260×4	220	154	161	250.83	31	25	12.1	AH 3148	HN 52
52	Tr 290×4	240	172	179	272.25	32	26	16.2	AH 3152	HN 58
56	Tr 310×5	260	175	183	292.42	34	28	17.6	AH 3156	HN 62
60	Tr 330×5	280	192	200	313.67	36	30	21.0	AH 3160	HN 66
64	Tr 350×5	300	209	217	335.00	37	31	24.7	AH 3164	HN 70
68	Tr 370×5	320	225	234	356.25	39	33	29.0	AH 3168	HN 74
72	Tr 400×5	340	229	238	376.42	41	35	33.1	AH 3172	HN 80
76	Tr 420×5	360	232	242	396.67	42	36	35.8	AH 3176	HN 84
80	Tr 440×5	380	240	250	417.17	44	38	38.9	AH 3180	HN 88
84	Tr 460×5	400	266	276	439.17	46	40	46.0	AH 3184	HN 92
88	Tr 480×5	420	270	281	459.42	48	42	49.2	AHX3188	HN 96
92	Tr 510×6	440	285	296	480.58	49	43	57.7	AHX3192	HN102
96	Tr 530×6	460	295	307	501.33	51	45	63.1	AHX3196	HN106
/500	Tr 550×6	480	313	325	522.67	53	47	70.9	AHX31/500	HN110

**Withdrawal Sleeves
Series AH2**

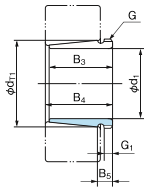

Bearing bore No.	Thread Nominal G	Dimensions (mm)							Mass (kg) (reference)	Withdrawal Sleeve No.	Locknut No.
		d1	B3	B4	d11	B5	G1 (reference)	G			
08	M 45 x 1.5	35	25	27	41.50	9	6	0.094	AH 208	AN 09	
09	M 50 x 1.5	40	26	29	46.67	9	6	0.104	AH 209	AN 10	
10	M 55 x 2	45	28	31	51.15	10	7	0.130	AH 210	AN 11	
11	M 60 x 2	50	29	32	56.83	10	7	0.167	AH 211	AN 12	
12	M 65 x 2	55	32	35	62.00	11	8	0.175	AH 212	AN 13	
13	M 75 x 2	60	32.5	36	67.08	11	8	0.242	AH 213	AN 15	
14	M 80 x 2	65	33.5	37	72.17	11	8	0.255	AH 214	AN 16	
15	M 85 x 2	70	34.5	38	77.25	11	8	0.280	AH 215	AN 17	
16	M 90 x 2	75	35.5	39	82.33	11	8	0.306	AH 216	AN 18	
17	M 95 x 2	80	38.5	42	87.50	12	9	0.353	AH 217	AN 19	
18	M 100 x 2	85	40	44	92.67	12	9	0.427	AH 218	AN 20	
19	M 105 x 2	90	43	47	97.83	13	10	0.486	AH 219	AN 21	
20	M 110 x 2	95	45	49	103.00	13	10	0.525	AH 220	AN 22	
21	M 115 x 2	100	47	51	108.08	14	11	0.580	AH 221	AN 23	
22	M 120 x 2	105	50	54	113.33	14	11	0.647	AH 222	AN 24	
24	M 130 x 2	115	53	57	123.50	15	12	0.755	AH 224	AN 26	
26	M 140 x 2	125	53	57	133.50	15	12	0.815	AH 226	AN 28	
28	M 150 x 2	135	56	61	143.75	16	13	1.00	AH 228	AN 30	
30	M 160 x 3	145	60	65	154.00	17	14	1.16	AH 230	AN 32	
32	M 170 x 3	150	64	69	164.25	18	15	1.91	AH 232	AN 34	
34	M 180 x 3	160	69	74	174.58	19	16	2.21	AH 234	AN 36	
36	M 190 x 3	170	69	74	184.58	19	16	2.34	AH 236	AN 38	
38	Tr 205 x 4	180	73	78	194.58	23	17	2.94	AH 238	HNL41	
40	Tr 215 x 4	190	77	82	204.83	24	18	3.12	AH 240	HNL43	
44	Tr 235 x 4	200	85	91	225.58	24	18	6.10	AH 244	HNL47	
48	Tr 260 x 4	220	96	102	246.17	28	22	8.16	AH 248	HNL52	
52	Tr 280 x 4	240	105	111	266.83	29	23	9.89	AH 252	HNL56	
56	Tr 300 x 4	260	105	113	287.00	29	23	10.4	AH 256	HNL60	

**Withdrawal Sleeves
Series AH22 / AH32 / AHX32**

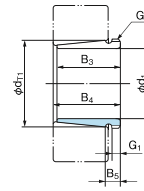

Bearing bore No.	Thread Nominal G	Dimensions (mm)							Mass (kg) (reference)	Withdrawal Sleeve No.	Locknut No.
		d1	B3	B4	d11	B5	G1 (reference)	G			
36	M 200 x 3	170	105	110	187.50	20	17	3.70	AH 2236	AN 40	
38	Tr 210 x 4	180	112	117	197.75	24	18	4.30	AH 2238	HN 42	
40	Tr 220 x 4	190	118	123	208.17	25	19	4.70	AH 2240	HN 44	
44	Tr 240 x 4	200	130	136	229.17	26	20	9.20	AH 2244	HN 48	
48	Tr 260 x 4	220	144	150	250.25	27	21	11.1	AH 2248	HN 52	
52	Tr 290 x 4	240	155	161	271.00	29	23	14.0	AH 2252	HN 58	
56	Tr 310 x 5	260	155	163	291.08	30	24	15.2	AH 2256	HN 62	
60	Tr 330 x 5	280	170	178	312.17	32	26	18.1	AH 2260	HN 66	
64	Tr 350 x 5	300	180	190	333.08	33	27	20.2	AH 2264	HN 70	
18	M 100 x 2	85	63	67	94.50	13	10	0.576	AHX3218	AN 20	
19	M 105 x 2	90	67	71	99.75	14	11	0.680	AH 3219	AN 21	
20	M 110 x 2	95	73	77	105.25	14	11	0.767	AHX3220	AN 22	
21	M 115 x 2	100	78	82	110.67	14	11	0.890	AH 3221	AN 23	
22	M 125 x 2	105	82	86	116.00	14	11	1.04	AHX3222	AN 25	
24	M 135 x 2	115	90	94	126.50	16	13	1.30	AHX3224	AN 27	
26	M 145 x 2	125	98	102	137.00	18	15	1.60	AHX3226	AN 29	
28	M 155 x 3	135	104	109	147.58	18	15	1.90	AHX3228	AN 31	
30	M 165 x 3	145	114	119	158.25	20	17	2.30	AHX3230	AN 33	
32	M 180 x 3	150	124	130	168.92	23	20	4.09	AH 3232	AN 36	
34	M 190 x 3	160	134	140	179.42	27	24	4.81	AH 3234	AN 38	
36	M 200 x 3	170	140	146	189.92	27	24	5.31	AH 3236	AN 40	
38	Tr 210 x 4	180	145	152	200.08	31	25	5.90	AH 3238	AN 42	
40	Tr 220 x 4	190	153	160	210.75	31	25	6.67	AH 3240	AN 44	
60	Tr 330 x 5	280	228	236	316.33	40	34	26.0	AH 3260	HN 66	
64	Tr 350 x 5	300	246	254	337.67	42	36	30.6	AH 3264	HN 70	
68	Tr 370 x 5	320	264	273	359.08	44	38	35.8	AH 3268	HN 74	
72	Tr 400 x 5	340	274	283	379.75	46	40	41.6	AH 3272	HN 80	
76	Tr 420 x 5	360	284	294	400.50	48	42	46.3	AH 3276	HN 84	
80	Tr 440 x 5	380	302	312	421.83	50	44	52.5	AH 3280	HN 88	
84	Tr 460 x 5	400	321	331	443.25	52	46	59.4	AH 3284	HN 92	
88	Tr 480 x 5	420	330	341	463.92	54	48	64.7	AHX3288	HN 96	
92	Tr 510 x 6	440	349	360	485.33	56	50	75.6	AHX3292	HN102	
96	Tr 530 x 6	460	364	376	506.50	58	52	83.6	AHX3296	HN106	
/500	Tr 550 x 6	480	393	405	528.75	60	54	94.7	AHX32500	HN110	

Withdrawal Sleeves
Series AH3 / AHX30

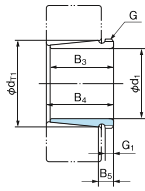

Bearing bore No.	Thread Nominal G	Dimensions (mm)						Mass (kg) (reference)	Withdrawal Sleeve No.	Locknut No.
		d ₁	B ₃	B ₄	d ₁	B ₅	G ₁ (reference)			
08	M 45×1.5	35	29	32	41.92	9	6	0.096	AH 308	AN 09
09	M 50×1.5	40	31	34	47.08	9	6	0.109	AH 309	AN 10
10	M 55×2	45	35	38	52.33	10	7	0.137	AHX310	AN 11
11	M 60×2	50	37	40	57.38	11.5	7	0.161	AHX311	AN 12
12	M 65×2	55	40	43	62.38	14.5	8	0.189	AHX312	AN 13
13	M 75×2	60	42	45	67.83	11	8	0.253	AH 313	AN 15
14	M 80×2	65	43	47	73.00	11	8	0.280	AH 314	AN 16
15	M 85×2	70	45	49	78.17	11	8	0.313	AH 315	AN 17
16	M 90×2	75	48	52	83.42	11	8	0.365	AH 316	AN 18
17	M 95×2	80	52	56	88.67	12	9	0.429	AHX317	AN 19
18	M 100×2	85	53	57	93.75	12	9	0.461	AHX318	AN 20
19	M 105×2	90	57	61	99.00	13	10	0.532	AHX319	AN 21
20	M 110×2	95	59	63	104.17	13	10	0.582	AHX320	AN 22
21	M 115×2	100	62	66	109.25	15	12	0.600	AHX321	AN 23
22	M 120×2	105	63	67	114.33	15	12	0.663	AHX322	AN 24
24	M 130×2	115	69	73	124.75	16	13	0.875	AHX324	AN 26
26	M 140×2	125	74	78	135.08	17	14	1.03	AHX326	AN 28
28	M 150×2	135	77	82	145.42	17	14	1.15	AHX328	AN 30
30	M 165×3	145	83	88	155.83	18	15	1.55	AHX330	AN 33
32	M 180×3	150	88	93	166.17	19	16	2.73	AH 332	AN 36
34	M 190×3	160	93	98	176.50	20	17	3.19	AH 334	AN 38

Withdrawal Sleeves
Series AH23 / AHX23

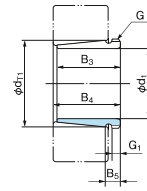

Bearing bore No.	Thread Nominal G	Dimensions (mm)						Mass (kg) (reference)	Withdrawal Sleeve No.	Locknut No.
		d ₁	B ₃	B ₄	d ₁	B ₅	G ₁ (reference)			
08	M 45×1.5	35	40	43	42.75	10	7	0.128	AH 2308	AN 09
09	M 50×1.5	40	44	47	48.00	11	7	0.164	AH 2309	AN 10
10	M 55×2	45	50	53	53.17	15	9	0.209	AHX2310	AN 11
11	M 60×2	50	54	57	58.42	16	10	0.253	AHX2311	AN 12
12	M 65×2	55	58	61	63.63	17.5	11	0.297	AHX2312	AN 13
13	M 75×2	60	61	64	69.08	15	12	0.395	AH 2313	AN 15
14	M 80×2	65	64	68	74.42	15	12	0.466	AHX2314	AN 16
15	M 85×2	70	68	72	79.75	15	12	0.534	AHX2315	AN 17
16	M 90×2	75	71	75	85.00	15	12	0.597	AHX2316	AN 18
17	M 95×2	80	74	78	90.17	16	13	0.670	AHX2317	AN 19
18	M 100×2	85	79	83	95.50	17	14	0.779	AHX2318	AN 20
19	M 105×2	90	85	89	100.83	19	16	0.886	AHX2319	AN 21
20	M 110×2	95	90	94	106.25	19	16	0.988	AHX2320	AN 22
21	—	—	—	—	—	—	—	—	—	—
22	M 125×2	105	98	102	116.92	19	16	1.35	AHX2322	AN 25
24	M 135×2	115	105	109	127.42	20	17	1.60	AHX2324	AN 27
26	M 145×2	125	115	119	138.08	22	19	2.00	AHX2326	AN 29
28	M 155×3	135	125	130	148.92	23	20	2.33	AHX2328	AN 31
30	M 165×3	145	135	140	159.42	27	24	2.82	AHX2330	AN 33
32	M 180×3	150	140	146	169.92	27	24	4.70	AH 2332	AN 36
34	M 190×3	160	146	152	180.42	27	24	5.30	AH 2334	AN 38
36	M 200×3	170	154	160	190.92	29	26	5.90	AH 2336	AN 40
38	Tr 210×4	180	160	167	201.25	32	26	6.50	AH 2338	HN 42
40	Tr 220×4	190	170	177	211.75	36	30	7.50	AH 2340	HN 44
44	Tr 240×4	200	181	189	232.75	36	30	13.4	AH 2344	HN 48
48	Tr 260×4	220	189	197	253.42	36	30	15.5	AH 2348	HN 52
52	Tr 290×4	240	205	213	274.75	36	30	20.0	AH 2352	HN 58
56	Tr 310×5	260	212	220	295.33	36	30	21.5	AH 2356	HN 62

Locknuts
Series AN / ANL

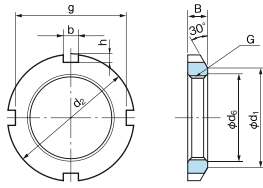

No.	Thread Nominal G	Dimensions (mm)							Mass (kg) (reference)	Lockwasher No.
		d ₁	d ₂	B	b	h	g	d ₅		
AN 02	M 15×1	21	25	5	4	2	21	15.5	0.010	AW 02
AN 03	M 17×1	24	28	5	4	2	24	17.5	0.013	AW 03
AN 04	M 20×1	26	32	6	4	2	28	20.5	0.019	AW 04
AN 05	M 25×1.5	32	38	7	5	2	34	25.8	0.025	AW 05
AN 06	M 30×1.5	38	45	7	5	2	41	30.8	0.043	AW 06
AN 07	M 35×1.5	44	52	8	5	2	48	35.8	0.053	AW 07
AN 08	M 40×1.5	50	58	9	6	2.5	53	40.8	0.085	AW 08
AN 09	M 45×1.5	56	65	10	6	2.5	60	45.8	0.119	AW 09
AN 10	M 50×1.5	61	70	11	6	2.5	65	50.8	0.148	AW 10
AN 11	M 55×2	67	75	11	7	3	69	56	0.158	AW 11
AN 12	M 60×2	73	80	11	7	3	74	61	0.174	AW 12
AN 13	M 65×2	79	85	12	7	3	79	66	0.203	AW 13
AN 14	M 70×2	85	92	12	8	3.5	85	71	0.242	AW 14
AN 15	M 75×2	90	98	13	8	3.5	91	76	0.287	AW 15
AN 16	M 80×2	95	105	15	8	3.5	98	81	0.397	AW 16
AN 17	M 85×2	102	110	16	8	3.5	103	86	0.451	AW 17
AN 18	M 90×2	108	120	16	10	4	112	91	0.556	AW 18
AN 19	M 95×2	113	125	17	10	4	117	96	0.658	AW 19
AN 20	M 100×2	120	130	18	10	4	122	101	0.698	AW 20
AN 21	M 105×2	126	140	18	12	5	130	106	0.845	AW 21
AN 22	M 110×2	133	145	19	12	5	135	111	0.965	AW 22
AN 23	M 115×2	137	150	19	12	5	140	116	1.01	AW 23
AN 24	M 120×2	138	155	20	12	5	145	121	1.08	AW 24
AN 25	M 125×2	148	160	21	12	5	150	126	1.19	AW 25
AN 26	M 130×2	149	165	21	12	5	155	131	1.25	AW 26
AN 27	M 135×2	160	175	22	14	6	163	136	1.55	AW 27
AN 28	M 140×2	160	180	22	14	6	168	141	1.56	AW 28
AN 29	M 145×2	171	190	24	14	6	178	146	2.00	AW 29
AN 30	M 150×2	171	195	24	14	6	183	151	2.03	AW 30
AN 31	M 155×3	182	200	25	16	7	186	156.5	2.21	AW 31
AN 32	M 160×3	182	210	25	16	7	196	161.5	2.59	AW 32
AN 33	M 165×3	193	210	26	16	7	196	166.5	2.43	AW 33
AN 34	M 170×3	193	220	26	16	7	206	171.5	2.80	AW 34
AN 36	M 180×3	203	230	27	18	8	214	181.5	3.07	AW 36
AN 38	M 190×3	214	240	28	18	8	224	191.5	3.39	AW 38
AN 40	M 200×3	226	250	29	18	8	234	201.5	3.69	AW 40

No.	Thread Nominal G	Dimensions (mm)							Mass (kg) (reference)	Lockwasher No.
		d ₁	d ₂	B	b	h	g	d ₅		
ANL 24	M 120×2	133	145	20	12	5	135	121	0.780	AWL24
ANL 26	M 130×2	143	155	21	12	5	145	131	0.880	AWL26
ANL 28	M 140×2	151	165	22	14	6	153	141	0.990	AWL28
ANL 30	M 150×2	164	180	24	14	6	168	151	1.38	AWL30
ANL 32	M 160×3	174	190	25	16	7	176	161.5	1.56	AWL32
ANL 34	M 170×3	184	200	26	16	7	186	171.5	1.72	AWL34
ANL 36	M 180×3	192	210	27	18	8	194	181.5	1.95	AWL36
ANL 38	M 190×3	202	220	28	18	8	204	191.5	2.08	AWL38
ANL 40	M 200×3	218	240	29	18	8	224	201.5	2.98	AWL40

Locknuts
Series AN / ANL

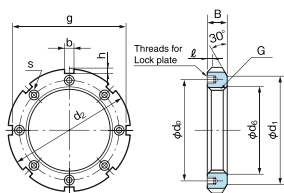

No.	Thread Nominal G	Dimensions (mm)										Mass (kg) (reference)	Lockwasher No.
		d ₁	d ₂	B	b	h	g	d ₆	l	s	d _p		
AN 44	Tr 220×4	250	280	32	20	10	260	222	15	M 8×1.25	238	5.20	AL 44
AN 48	Tr 240×4	270	300	34	20	10	280	242	15	M 8×1.25	258	5.95	AL 44
AN 52	Tr 260×4	300	330	36	24	12	306	262	18	M 10×1.5	281	8.05	AL 52
AN 56	Tr 280×4	320	350	38	24	12	326	282	18	M 10×1.5	301	9.05	AL 52
AN 60	Tr 300×4	340	380	40	24	12	356	302	18	M 10×1.5	326	11.8	AL 60
AN 64	Tr 320×5	360	400	42	24	12	376	322.5	18	M 10×1.5	345	13.1	AL 64
AN 68	Tr 340×5	400	440	55	28	15	410	342.5	21	M 12×1.75	372	23.1	AL 68
AN 72	Tr 360×5	420	460	58	28	15	430	362.5	21	M 12×1.75	392	25.1	AL 68
AN 76	Tr 380×5	450	490	60	32	18	454	382.5	21	M 12×1.75	414	30.9	AL 76
AN 80	Tr 400×5	470	520	62	32	18	484	402.5	27	M 16×2	439	36.9	AL 80
AN 84	Tr 420×5	490	540	70	32	18	504	422.5	27	M 16×2	459	43.5	AL 80
AN 88	Tr 440×5	510	560	70	36	20	520	442.5	27	M 16×2	477	45.3	AL 88
AN 92	Tr 460×5	540	580	75	36	20	540	462.5	27	M 16×2	497	50.4	AL 88
AN 96	Tr 480×5	560	620	75	36	20	580	482.5	27	M 16×2	527	62.2	AL 96
AN 100	Tr 500×5	580	630	80	40	23	584	502.5	27	M 16×2	539	63.3	AL 100
ANL 44	Tr 220×4	242	260	30	20	9	242	222	12	M 6×1	229	3.09	ALL 44
ANL 48	Tr 240×4	270	290	34	20	10	270	242	15	M 8×1.25	253	5.16	ALL 48
ANL 52	Tr 260×4	290	310	34	20	10	290	262	15	M 8×1.25	273	5.67	ALL 48
ANL 56	Tr 280×4	310	330	38	24	10	310	282	15	M 8×1.25	293	6.78	ALL 56
ANL 60	Tr 300×4	336	360	42	24	12	336	302	15	M 8×1.25	316	9.62	ALL 60
ANL 64	Tr 320×5	356	380	42	24	12	356	322.5	15	M 8×1.25	335	9.94	ALL 64
ANL 68	Tr 340×5	376	400	45	24	12	376	342.5	15	M 8×1.25	355	11.7	ALL 64
ANL 72	Tr 360×5	394	420	45	28	13	394	362.5	15	M 8×1.25	374	12.0	ALL 72
ANL 76	Tr 380×5	422	450	48	28	14	422	382.5	18	M 10×1.5	398	14.9	ALL 76
ANL 80	Tr 400×5	442	470	52	28	14	442	402.5	18	M 10×1.5	418	16.9	ALL 76
ANL 84	Tr 420×5	462	490	52	32	14	462	422.5	18	M 10×1.5	438	17.4	ALL 84
ANL 88	Tr 440×5	490	520	60	32	15	490	442.5	21	M 12×1.75	462	26.2	ALL 88
ANL 92	Tr 460×5	510	540	60	32	15	510	462.5	21	M 12×1.75	482	29.6	ALL 88
ANL 96	Tr 480×5	530	560	60	36	15	530	482.5	21	M 12×1.75	502	28.3	ALL 96
ANL100	Tr 500×5	550	580	68	36	15	550	502.5	21	M 12×1.75	522	33.6	ALL 96

Nuts for withdrawal sleeves
Series HN / HNL

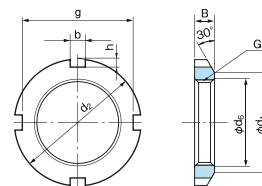

No.	Thread Nominal G	Dimensions (mm)								Mass (kg) (reference)
		d ₁	d ₂	B	b	h	g	d ₆		
HN 42	Tr 210×4	238	270	30	20	10	250	212	4.75	
HN 44	Tr 220×4	250	280	32	20	10	260	222	5.35	
HN 48	Tr 240×4	270	300	34	20	10	280	242	6.20	
HN 52	Tr 260×4	300	330	36	24	12	306	262	8.55	
HN 58	Tr 290×4	330	370	40	24	12	346	292	11.8	
HN 62	Tr 310×5	350	390	42	24	12	366	312.5	13.4	
HN 66	Tr 330×5	380	420	52	28	15	390	332.5	20.4	
HN 70	Tr 350×5	410	450	55	28	15	420	352.5	25.2	
HN 74	Tr 370×5	430	470	58	28	15	440	372.5	28.2	
HN 80	Tr 400×5	470	520	62	32	18	484	402.5	40.0	
HN 84	Tr 420×5	490	540	70	32	18	504	422.5	46.9	
HN 88	Tr 440×5	510	560	70	36	20	520	442.5	48.5	
HN 92	Tr 460×5	540	580	75	36	20	540	462.5	55.0	
HN 96	Tr 480×5	560	620	75	36	20	580	482.5	67.0	
HN 102	Tr 510×6	590	650	80	40	23	604	513	69.0	
HN 106	Tr 530×6	610	670	80	40	23	624	533	78.0	
HN 110	Tr 550×6	640	700	80	40	23	654	553	92.5	
HNL 41	Tr 205×4	232	250	30	18	8	234	207	3.43	
HNL 43	Tr 215×4	242	260	30	20	9	242	217	3.72	
HNL 47	Tr 235×4	262	280	34	20	9	262	237	4.60	
HNL 52	Tr 260×4	290	310	34	20	10	290	262	5.80	
HNL 56	Tr 280×4	310	330	38	24	10	310	282	6.72	
HNL 60	Tr 300×4	336	360	42	24	12	336	302	9.60	
HNL 64	Tr 320×5	356	380	42	24	12	356	322.5	10.3	
HNL 69	Tr 345×5	384	410	45	28	13	384	347.5	11.5	
HNL 73	Tr 365×5	404	430	48	28	13	404	367.5	14.2	
HNL 77	Tr 385×5	422	450	48	28	14	422	387.5	15.0	
HNL 82	Tr 410×5	452	480	52	32	14	452	412.5	19.0	
HNL 86	Tr 430×5	472	500	52	32	14	472	432.5	19.8	
HNL 90	Tr 450×5	490	520	60	32	15	490	452.5	23.8	
HNL 94	Tr 470×5	510	540	60	32	15	510	472.5	25.0	
HNL 98	Tr 490×5	550	580	60	36	15	550	492.5	34.0	
HNL104	Tr 520×6	570	600	68	36	15	570	523	37.0	
HNL108	Tr 540×6	590	630	68	40	20	590	543	43.5	

Lockwashers
Series AW / AWL

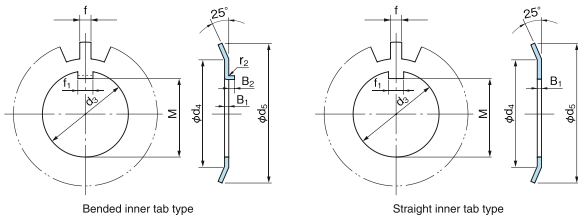

No.		Dimensions (mm)											Locknut No.
Bended inner tab	Straight inner tab	d ₃	d ₄	d ₅	f ₁	M	B ₁	B ₂	r ₂	f	No. of Teeth	Mass (kg/100pcs) (reference)	
AW 02	AW 02X	15	21	28	4	13.5	1	2.5	1	4	13	0.253	AN 02
AW 03	AW 03X	17	24	32	4	15.5	1	2.5	1	4	13	0.313	AN 03
AW 04	AW 04X	20	26	36	4	18.5	1	2.5	1	4	13	0.350	AN 04
AW 05	AW 05X	25	32	42	5	23	1.2	2.5	1	5	13	0.640	AN 05
AW 06	AW 06X	30	38	49	5	27.5	1.2	2.5	1	5	13	0.780	AN 06
AW 07	AW 07X	35	44	57	6	32.5	1.2	2.5	1	5	15	1.04	AN 07
AW 08	AW 08X	40	50	62	6	37.5	1.2	2.5	1	6	15	1.23	AN 08
AW 09	AW 09X	45	56	69	6	42.5	1.2	2.5	1	6	17	1.52	AN 09
AW 10	AW 10X	50	61	74	6	47.5	1.2	2.5	1	6	17	1.60	AN 10
AW 11	AW 11X	55	67	81	8	52.5	1.2	4	1	7	17	1.96	AN 11
AW 12	AW 12X	60	73	86	8	57.5	1.5	4	1.2	7	17	2.53	AN 12
AW 13	AW 13X	65	79	92	8	62.5	1.5	4	1.2	7	19	2.90	AN 13
AW 14	AW 14X	70	85	98	8	66.5	1.5	4	1.2	8	19	3.34	AN 14
AW 15	AW 15X	75	90	104	8	71.5	1.5	4	1.2	8	19	3.56	AN 15
AW 16	AW 16X	80	95	112	10	76.5	1.8	4	1.2	8	19	4.64	AN 16
AW 17	AW 17X	85	102	119	10	81.5	1.8	4	1.2	8	19	5.24	AN 17
AW 18	AW 18X	90	108	126	10	86.5	1.8	4	1.2	10	19	6.23	AN 18
AW 19	AW 19X	95	113	133	10	91.5	1.8	4	1.2	10	19	6.70	AN 19
AW 20	AW 20X	100	120	142	12	96.5	1.8	6	1.2	10	19	7.65	AN 20
AW 21	AW 21X	105	126	145	12	100.5	1.8	6	1.2	12	19	8.26	AN 21
AW 22	AW 22X	110	133	154	12	105.5	1.8	6	1.2	12	19	9.40	AN 22
AW 23	AW 23X	115	137	159	12	110.5	2	6	1.5	12	19	10.8	AN 23
AW 24	AW 24X	120	138	164	14	115	2	6	1.5	12	19	10.5	AN 24
AW 25	AW 25X	125	148	170	14	120	2	6	1.5	12	19	11.8	AN 25
AW 26	AW 26X	130	149	175	14	125	2	6	1.5	12	19	11.3	AN 26
AW 27	AW 27X	135	160	185	14	130	2	6	1.5	14	19	14.4	AN 27
AW 28	AW 28X	140	160	192	16	135	2	8	1.5	14	19	14.2	AN 28
AW 29	AW 29X	145	171	202	16	140	2	8	1.5	14	19	16.8	AN 29
AW 30	AW 30X	150	171	205	16	145	2	8	1.5	14	19	15.5	AN 30
AW 31	AW 31X	155	182	212	16	147.5	2.5	8	1.5	16	19	20.9	AN 31
AW 32	AW 32X	160	182	217	18	154	2.5	8	1.5	16	19	22.2	AN 32
AW 33	AW 33X	165	193	222	18	157.5	2.5	8	1.5	16	19	24.1	AN 33
AW 34	AW 34X	170	193	232	18	164	2.5	8	1.5	16	19	24.7	AN 34
AW 36	AW 36X	180	203	242	20	174	2.5	8	1.5	18	19	26.8	AN 36
AW 38	AW 38X	190	214	252	20	184	2.5	8	1.5	18	19	27.8	AN 38
AW 40	AW 40X	200	226	262	20	194	2.5	8	1.5	18	19	29.3	AN 40

No.		Dimensions (mm)											Locknut No.
Bended inner tab	Straight inner tab	d ₃	d ₄	d ₅	f ₁	M	B ₁	B ₂	r ₂	f	No. of Teeth	Mass (kg/100pcs) (reference)	
AWL 24	AWL 24X	120	133	155	14	115	2	6	1.5	12	19	7.70	ANL 24
AWL 26	AWL 26X	130	143	165	14	125	2	6	1.5	12	19	8.70	ANL 26
AWL 28	AWL 28X	140	151	175	16	135	2	8	1.5	14	19	10.9	ANL 28
AWL 30	AWL 30X	150	164	190	16	145	2	8	1.5	14	19	11.3	ANL 30
AWL 32	AWL 32X	160	174	200	18	154	2.5	8	1.5	16	19	16.2	ANL 32
AWL 34	AWL 34X	170	184	210	18	164	2.5	8	1.5	16	19	19.0	ANL 34
AWL 36	AWL 36X	180	192	220	20	174	2.5	8	1.5	18	19	18.0	ANL 36
AWL 38	AWL 38X	190	202	230	20	184	2.5	8	1.5	18	19	20.5	ANL 38
AWL 40	AWL 40X	200	218	250	20	194	2.5	8	1.5	18	19	21.4	ANL 40

Remark: Narrow slot adapters with part numbers with an X suffix in the series H2, H3 and H23 use straight type inner tabs. Wide slot adapters with part numbers with an X suffix can use either bended or straight inner tabs.

Lock Plates
Series AL / ALL

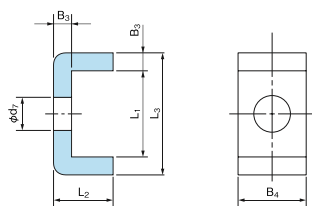

No.	Dimensions (mm)						Mass (kg/100pcs) (reference)	Nut No.
	B ₃	B ₄	L ₂	d ₇	L ₁	L ₃		
AL 44	4	20	12	9	22.5	30.5	2.60	AN44 , AN48
AL 52	4	24	12	12	25.5	33.5	3.39	AN52 , AN56
AL 60	4	24	12	12	30.5	38.5	3.79	AN60
AL 64	5	24	15	12	31	41	5.35	AN64
AL 68	5	28	15	14	38	48	6.65	AN68 , AN72
AL 76	5	32	15	14	40	50	7.96	AN76
AL 80	5	32	15	18	45	55	8.20	AN80 , AN84
AL 88	5	36	15	18	43	53	9.00	AN88 , AN92
AL 96	5	36	15	18	53	63	10.4	AN96
AL 100	5	40	15	18	45	55	10.5	AN100
ALL 44	4	20	12	7	13.5	21.5	2.12	ANL44
ALL 48	4	20	12	9	17.5	25.5	2.29	ANL48, ANL52
ALL 56	4	24	12	9	17.5	25.5	2.92	ANL56
ALL 60	4	24	12	9	20.5	28.5	3.16	ANL60
ALL 64	5	24	15	9	21	31	4.56	ANL64, ANL68
ALL 72	5	28	15	9	20	30	5.03	ANL72
ALL 76	5	28	15	12	24	34	5.28	ANL76, ANL80
ALL 84	5	32	15	12	24	34	6.11	ANL84
ALL 88	5	32	15	14	28	38	6.45	ANL88, ANL92
ALL 96	5	36	15	14	28	38	7.29	ANL96, ANL100

■ Dish Spring for Bearings

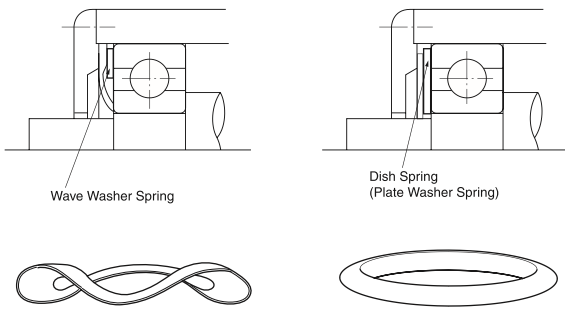

The application for electrical motors may sometimes require that the bearings be provided with appropriate preload when assembled. In case of motors the residual clearance 0 after mounting is best for low noise. Preload has the following various purposes and effects.

<Purpose of Preload>

- (1) Enhances rotating accuracy of shaft. Minimizes axial movements and helps to prevent vibration and decrease noise.
- (2) Prevents fretting caused by external vibration.
- (3) Increases rigidity of a shaft (that is, preloading can help to decrease the deflection of shafting).

<Preloading method>

Use of springs (wave washer spring or dish spring) "Constant pressure" preloading. The preload for electrical motor bearings may be calculated by using the following equations.
 T_p = Preload Force (kgf) d = Inner Ring Bore Diameter (mm)

$T_p = (0.4 \sim 0.8)d$ or $T_p = 0.6d \sim 3$

Preload by Dish Springs for Bearings

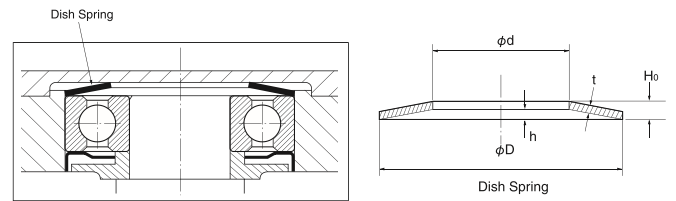

Bearing No.	Bearing I.D (dmm)	Spring No.	Target Preload (Tp N)		Recommended Preload (N)	Flexure (dmm)	Spring Hgt (Ho mm)
			$T_p = (0.4 \sim 0.8)d$ Range	$T_p = 0.6d \sim 3$			
6001	12	HDS-28	47.0~94.1	41.2	88.7	0.25	0.75
6002	15	HDS-32	58.8~117.6	58.8	100.0	0.41	0.64
6003	17	HDS-35b	66.6~133.3	70.6	110.0	0.28	0.87
6004	20	HDS-42	78.4~156.8	88.2	116.0	0.38	0.97
6005	25	HDS-47	98.0~196.0	117.6	145.0	0.38	1.07
6006	30	HDS-55	117.6~235.2	147.0	163.0	0.56	0.89
6007	35	HDS-62	137.2~274.4	176.4	168.0	0.48	1.27
6008	40	HDS-68	156.8~313.6	205.8	183.0	0.64	1.01
6009	45	HDS-75	176.4~352.8	235.2	236.0	0.56	1.19
6010	50	HDS-80b	196.0~392.0	264.6	256.0	0.58	1.57
6011	55	HDS-90b	215.6~431.2	294.0	321.0	0.55	1.75
6200	10	HDS-30	39.2~78.4	29.4	84.2	0.28	0.77
6201	12	HDS-32	47.0~94.1	41.2	82.6	0.28	0.77
6202	15	HDS-35b	58.8~117.6	58.8	110.0	0.28	0.87
6203	17	HDS-40	66.6~133.3	70.6	107.0	0.33	0.92
6204	20	HDS-47	78.4~156.8	88.2	145.0	0.38	1.07
6205	25	HDS-52	98.0~196.0	117.6	128.0	0.38	1.07
6206	30	HDS-62	117.6~235.2	147.0	168.0	0.48	1.27
6207	35	HDS-72b	137.2~274.4	176.4	219.0	0.45	1.45
6208	40	HDS-80b	156.8~313.6	205.8	256.0	0.58	1.57
6209	45	HDS-85	176.4~352.8	235.2	344.0	0.55	1.75
6210	50	HDS-90b	196.0~392.0	264.6	321.0	0.55	1.75
6300	10	HDS-35a	39.2~78.4	29.4	62.0	0.28	0.77
6301	12	HDS-37	47.0~94.1	41.2	108.0	0.33	0.92
6302	15	HDS-42	58.8~117.6	58.8	116.0	0.38	0.97
6303	17	HDS-47	66.6~133.3	70.6	145.0	0.38	1.07
6304	20	HDS-52	78.4~156.8	88.2	128.0	0.38	1.07
6305	25	HDS-62	98.0~196.0	117.6	168.0	0.48	1.27
6306	30	HDS-72a	117.6~235.2	147.0	253.0	0.55	1.55
6307	35	HDS-80a	137.2~274.4	176.4	221.0	0.58	1.57
6308	40	HDS-90a	156.8~313.6	205.8	276.0	0.55	1.75
6309	45	HDS-100a	176.4~352.8	235.2	266.0	0.63	1.82
6310	50	HDS-110a	196.0~392.0	264.6	304.0	0.78	1.97

Dish Spring List for Bearings

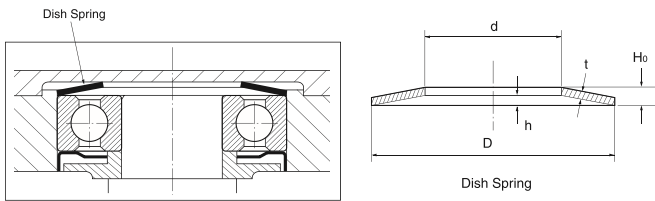

Size	Applicable Bearing No.	Dish Spring Size (mm)					Spring Load (N)				Unit (mm)
		D	d	t	h	Ho	Flexure 0.5h		Flexure 0.75h		
							P	δ	P	δ	
HDS-10	EL3 623	9.8	6.2	0.20	0.20	0.40	18.40	0.10	23.20	0.15	
HDS-13	EL4 624	12.8	7.2	0.25	0.25	0.50	23.90	0.13	29.70	0.19	
HDS-16	R4 EL5 625 634	15.8	8.2	0.30	0.30	0.55	19.40	0.15	23.40	0.23	
HDS-19a	R5 EL6 626 635	18.8	9.2	0.30	0.35	0.65	26.60	0.18	31.50	0.26	
HDS-19b	EL7 607	10.2	10.2			0.70	41.20		50.80		
HDS-22	R7 EL8 608 627 636	21.8	12.3	0.35	0.40	0.75	38.40	0.20	46.60	0.30	
HDS-24	EL9 609 628	23.7	23.7			0.90	68.80		81.30		
HDS-26	R9 6000 629 637	25.7	14.3	0.40	0.50	0.90	54.30	0.25	64.10	0.38	
HDS-28	6001 638	27.7	27.7		1.00	88.70	113.00				
HDS-30	6200	29.7	17.3	0.50	0.50	1.00	84.20		102.00		
HDS-32	6002 6201	31.7	20.4	0.55	1.05	82.60	100.00				
HDS-35a	6300	34.6	22.4	0.60	1.15	110.00	139.00	0.28	76.00	0.41	
HDS-35b	6003 6202	36.6	20.4	0.60	1.15	110.00	139.00	0.33	107.00	0.49	
HDS-37	6203 6301	39.6	25.5	0.65	1.25	107.00	131.00				
HDS-40	6004 6203	41.6	30.5	0.70	1.35	116.00	135.00				
HDS-42	6005 6204 6303	46.5	30.5	0.75	1.45	145.00	177.00				
HDS-52	6205 6304	51.5	35.5	0.80	1.75	177.00	236.00	0.38	128.00	0.56	
HDS-55	6006 6305	54.5	40.5	0.85	1.85	148.00	183.00	0.43	133.00	0.64	
HDS-62	6007 6206 6305	61.5	50.5	0.90	1.90	219.00	296.00	0.45	221.00	0.86	
HDS-68	6008 6306	67.5	55.5	1.00	2.15	256.00	308.00	0.58	128.00	0.68	
HDS-72a	6207	71.5	50.5	1.00	2.15	256.00	308.00	0.58	133.00	0.86	
HDS-72b	6009 6307	74.5	55.5	1.10	2.30	276.00	357.00	0.55	221.00	0.86	
HDS-75	6010 6208	79.5	55.5	1.15	2.15	256.00	308.00	0.58	276.00	0.86	
HDS-80a	6209	84.5	60.5	1.20	2.45	266.00	331.00	0.63	344.00	0.86	
HDS-80b	6308	89.5	65.5	1.25	2.45	303.00	376.00	0.63	276.00	0.86	
HDS-90a	6011 6210	94.5	75.5	1.30	2.50	321.00	393.00	0.65	321.00	0.98	
HDS-90b	6012 6309	99.0	70.5	1.35	2.50	321.00	393.00	0.65	321.00	0.98	
HDS-100a	6013 6211	109.0	75.5	1.40	2.50	321.00	393.00	0.65	321.00	0.98	
HDS-100b	6310	109.0	75.5	1.40	2.50	321.00	393.00	0.65	321.00	0.98	
HDS-110a	6014 6212	114.0	75.5	1.45	2.50	321.00	393.00	0.65	321.00	0.98	
HDS-110b	6015 6311	119.0	75.5	1.50	2.50	321.00	393.00	0.65	321.00	0.98	
HDS-115											
HDS-120a											

Size	Applicable Bearing No.	Dish Spring Size (mm)					Spring Load (N)				Unit (mm)
		D	d	t	h	Ho	Flexure 0.5h		Flexure 0.75h		
							P	δ	P	δ	
HDS-120b	6213	119.0	85.5								
HDS-125	6016 6214	124.0	90.5	1.20	1.55	2.75	305.00	0.78	354.00	1.16	
HDS-130a	6312		85.5				438.00		533.00		
HDS-130b	6017 6215	129.0	95.5		1.70	3.20	540.00	0.85	657.00	1.28	
HDS-140a	6313		90.5				368.00		448.00		
HDS-140b	6018 6216	139.0	101.0	1.50	1.75	3.25	469.00	0.88	563.00	1.31	
HDS-150a	6314		95.5				313.00		381.00		
HDS-150b	6217	149.0	106.0		1.70	3.20	371.00	0.85	452.00	1.28	
HDS-160a	6315		101.0				365.00		440.00		
HDS-160b	6218	159.0	111.0	1.60	1.85	3.45	422.00	0.93	508.00	1.39	
HDS-170a	6316		106.0				403.00		469.00		
HDS-170b	6219	169.0	121.0		2.05	3.65	467.00	1.03	544.00	1.54	
HDS-180a	6317		106.0				371.00		452.00		
HDS-180b	6220	179.0	126.0		2.20	4.20	506.00	1.10	600.00	1.65	
HDS-190a	6318		121.0				469.00		563.00		
HDS-190b	6221	189.0	131.0	2.00	2.30	4.30	529.00	1.15	636.00	1.73	
HDS-200a	6319		126.0				469.00		563.00		
HDS-200b	6222	198.0	141.0		2.50	4.50	580.00	1.25	700.00	1.88	
HDS-215a	6320		131.0				529.00		636.00		
HDS-225	6321	223.0	151.0	2.30	2.30	4.60	783.00	1.15	989.00	1.73	
HDS-230	6226	228.0	161.0		2.60	4.90	870.00	1.30	1060.00	1.95	
HDS-240	6322		136.0				636.00		770.00		
HDS-250	6228	248.0	171.0		2.85	5.15	960.00	1.43	1200.00	2.14	
HDS-260	6324		141.0				819.00		1000.00		
HDS-270	6230	268.0	181.0	2.50	3.00	5.50	951.00	1.50	1130.00	2.25	
HDS-280	6326		141.0				819.00		1000.00		
HDS-290	6232	288.0	193.0		3.10	5.60	960.00	1.55	1130.00	2.33	
HDS-300	6328		141.0				819.00		1000.00		
HDS-310	6234	308.0	202.0		3.25	5.75	992.00	1.63	1200.00	2.44	
HDS-320a	6330		141.0				819.00		1000.00		
HDS-340a	6332	338.0	212.0		3.10	6.10	1070.00	1.55	1300.00	2.33	
HDS-360a	6334	358.0	242.0	3.00	3.20	6.20	1080.00	1.60	1340.00	2.40	
HDS-380	6336	378.0	252.0		3.60	6.60	1220.00	1.80	1450.00	2.70	
HDS-400	6338	398.0	262.0	3.50	3.90	6.90	1210.00	1.95	1410.00	2.93	
HDS-420	6340	418.0	272.0	4.00	4.20	7.70	1520.00	2.10	1810.00	3.15	

Material: Carbon spring steel between S65CM and S75CM (JIS)
 Hardness: between HRC38 and HRC45

Wave Springs for Bearings (Reference)

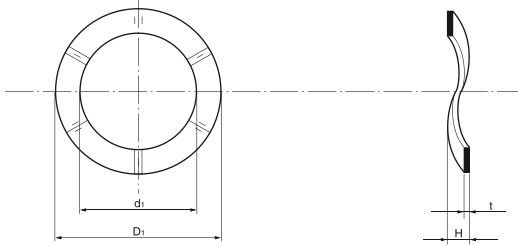

$W=0.6d-3$ W : Preload(Kgf)/ d : Bore diameter
 $L=(1.94 \times dm^3 \times W)/(E \times b \times 13 \times N)(mm)$
 L : elastic displacement (mm)
 $dm=(d1+D1)/2$ (mm) $b=(D1-d1)/2$ (mm)
 t : thickness of sheet (mm)
 $E=20000$ (kgf/mm²)
 N : wave number

Spring No.	Outside Diameter of Bearing (mm)	d1: Bore Diameter of Spring (mm)	D1: Outside Diameter of Spring (mm)	H: Height of Spring (mm)	t: Thickness of Sheet (mm)	Wave Number	Spring Constant (mm/kgf)	Applied Bearing No.					
W22	22	14.5	21	2.4	0.2	3	0.2576	6900					
W26	26	19.5	24.8	3.2	0.2	3	0.9139		6000				
W28	28	20.9	26.9	3	0.25	3	0.3488	6902	6001				
W30	30	22	28.5	4.1	0.25	3	0.3796	6903		6200			
W32	32	23.5	30.5	4	0.25	3	0.4310		6002	6201			
W35	35	26.4	33.9	3.5	0.3	3	0.3242		6003	6202	6300		
W40	40	29.8	38.3	5	0.3	3	0.4120		6203				
W42	42	30.1	40.6	4.5	0.3	3	0.3732	6905	6004			6302	
W47	47	33.7	45.5	5	0.3	3	0.4688	6906	6005	6204	6303		
W52	52	38.5	50	7.2	0.3	3	0.6683		6205	6304			
W62	62	47.2	60.2	6.5	0.4	3	0.4458	6908	6007	6206	6305	6403	
W72	72	55	70.5	7	0.45	3	0.4190	6910		6207	6306	6404	
W80	80	61.3	77.8	8.5	0.45	3	0.5359	6911	6010	6208	6307	6405	
W90	90	69	88.5	7	0.6	3	0.2777	6913	6011	6210	6308	6406	
W100	100	79.3	98.8	6.5	0.7	3	0.2529	6914	6013	6211	6309	6407	
W110	110	88.9	108.9	8	0.8	3	0.2263	6916	6014	6212	6310	6408	
W120	120	95.8	118.9	8.5	0.8	3	0.2505	6917		6213	6311	6409	
W130	130	108.3	128.3	11	0.8	3	0.3872	6919	6017	6215	6312	6410	
W140	140	112.4	138.4	11	0.8	3	0.3548	6920	6018	6216	6313	6411	

Material: Spring Steel (JIS G3311/JIS G3506)HARDNESS: HRC40-50/SURFACE TREATMENT PHOSPHATE COATING

Notes: 1. 't' means thickness of raw sheet.

2. 'd1' means inscribed circle and 'D1' means circumscribed circle.

3. 'H' means the height of spring of which the tops of 3 waves indicate same height first of all when it is compressed between 2 parallel plates

Convenient Locking Nuts for Bearings

Dimension Table for Fine U-NUT

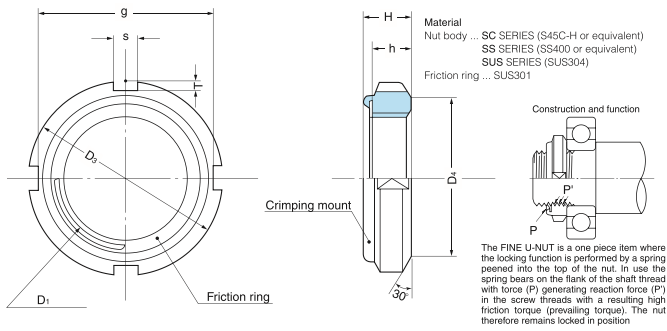

Thread accuracy: ISO6H(JIS CLASS2) Unit: mm

SC Series	SS Series	SUS Series	Designation of thread D_1	D_2	D_4	g	T	S	h	H	Perpendicularity of bearing surface
FU00SC	FU00SS	FU00SUS	M10×0.75	18	13.5	14.4	1.8	3	4	5.2	± 0.3
FU01SC	FU01SS	FU01SUS	M12×1.0	22	17	18.4	1.8	3	4	5.4	
FU02SC	FU02SS	FU02SUS	M15×1.0	25	21	21.4	1.8	4	5	6.5	
FU03SC	FU03SS	FU03SUS	M17×1.0	28	24	24.2	1.8	4	5	6.4	
FU04SC	FU04SS	FU04SUS	M20×1.0	32	26	28.4	1.8	4	6	7.7	
FU05SC	FU05SS	FU05SUS	M25×1.5	38	32	34	2	5	7	9.1	
FU06SC	FU06SS	FU06SUS	M30×1.5	45	38	41	2	5	7	9.1	
FU07SC	FU07SS	FU07SUS	M35×1.5	52	44	48	2	5	8	10.2	
FU08SC	FU08SS	FU08SUS	M40×1.5	58	50	53	2.5	6	9	11.2	
FU09SC	FU09SS	FU09SUS	M45×1.5	65	56	60	2.5	6	10	12.5	
FU10SC	FU10SS	FU10SUS	M50×1.5	70	61	65	2.5	6	11	13.5	
FU11SC	FU11SS	FU11SUS	M55×2.0	75	67	69	3	7	11	13.5	
FU12SC	FU12SS	FU12SUS	M60×2.0	80	73	74	3	7	11	13.5	
FU13SC	FU13SS	FU13SUS	M65×2.0	85	79	79	3	7	12	15	
FU14SC	FU14SS	FU14SUS	M70×2.0	92	85	85	3.5	8	12	15	
FU15SC	FU15SS	FU15SUS	M75×2.0	98	90	91	3.5	8	13	15.8	
FU16SC	FU16SS	FU16SUS	M80×2.0	105	95	98	3.5	8	15	18.6	
FU17SC	FU17SS	FU17SUS	M85×2.0	110	102	103	3.5	8	16	19.2	
FU18SC	FU18SS	FU18SUS	M90×2.0	120	108	112	4	10	16	20.3	
FU19SC	FU19SS	FU19SUS	M95×2.0	125	113	117	4	10	17	21.3	
FU20SC	FU20SS	FU20SUS	M100×2.0	130	120	122	4	10	18	22.3	
FU21SC	—	—	M105×2.0	140	126	130	4	12	18	22.3	
FU22SC	—	—	M110×2.0	145	133	135	5	12	19	23.3	
FU23SC	—	—	M115×2.0	150	137	140	5	12	19	23.3	
FU24SC	—	—	M120×2.0	155	138	145	5	12	20	24.3	
FU25SC	—	—	M125×2.0	160	148	150	5	12	21	25.4	
FU26SC	—	—	M130×2.0	165	149	155	5	12	21	25.4	
FU27SC	—	—	M135×2.0	175	160	163	6	14	22	26.6	
FU28SC	—	—	M140×2.0	180	160	168	6	14	22	26.6	
FU29SC	—	—	M145×2.0	190	171	178	6	14	24	28.6	
FU30SC	—	—	M150×2.0	195	171	183	6	14	24	28.3	

* Dimensions may be subject to change without notice due to our policy of product improvements.

Construction and Function

The TWIN FU-NUT has two friction rings and a spacer which are secured to the upper surface of the nut, as shown below. The two friction rings are arranged so that

stress P generated by the spring action and the reaction P' act symmetrically about the shaft centre. This arrangement ensures an even contact force F around the contact face.

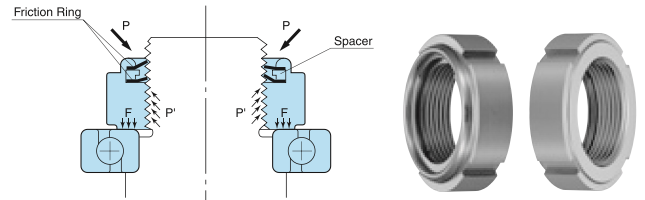

- Accuracy of thread is ISO 4H
- Excellent locking performance
- Bearing surface run out to thread form is held to within a few microns
- Simple assembly, as for a standard nut

Dimension Table for Twin FU-NUT

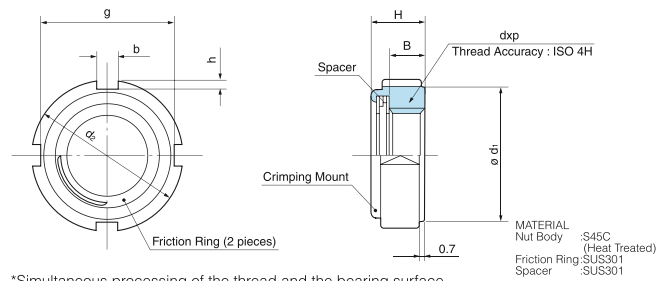

*Simultaneous processing of the thread and the bearing surface.

Dimensions in millimeters

Code No.	$d \times p$	ϕd_1	d_2	H	B	b	h	g	$t_{min}=B+3.5p$	Allowable axial dead load (kN)	
TFU02SC	M15 × 1	21	25	9.9	7	4	1.8	21.4	10.5	34.1	
TFU03SC	M17 × 1	23.5	28	10.1	7	4	2	24	10.5	38.6	
TFU04SC	M20 × 1	27	32	12.3	9	4	2	28	12.5	59.4	
TFU05SC	M25 × 1.5	33	38	14.2	10	5	2	34	15.3	80.8	
TFU06SC	M30 × 1.5	40	45	16.5	12	5	2	41	15.3	97.0	
TFU07SC	M35 × 1.5	47	52	16.5	14.3	±0.5	10	5	±0.2	17.3	137.8
TFU08SC	M40 × 1.5	52	58	17.6	13	6	2.5	53	18.3	171.4	
TFU09SC	M45 × 1.5	59	65	19.7	15	6	2.5	60	20.3	224.5	
TFU10SC	M50 × 1.5	64	70	20.8	16	6	2.5	65	21.3	266.8	

Convenient HLB Locking Nuts for Bearings

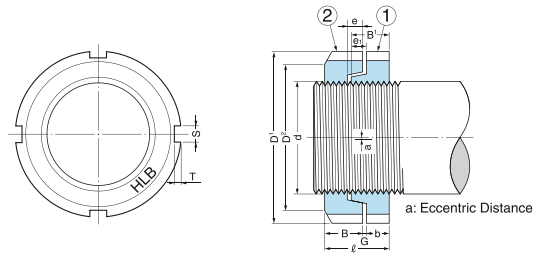
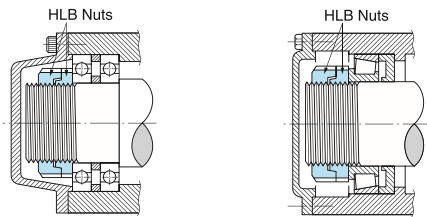

Material: SS400, S45C or SUS304
 Outside shapes are standardized in JIS B 1554 and thread accuracy depends on ISO6H(JIS CLASS2).

Unit: mm

Structure and Function

Locking performance of HLB nuts is based on the principle of a wedge. After a lower nut is tightened, the upper nut is tightened by hand. In this case, there is the clearance(G) between the lower nut and the upper nut.

The clearance(G) generates strong force and this force works to prevent the nuts from loosening, when the upper nut is tightened up to 0 clearance. Because the cone of the lower nut and the cup of the upper nut are eccentric.

At this point of the cone and cup, a strong wedge effort is generated.

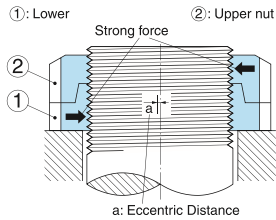
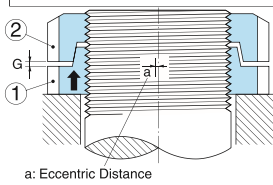

Nut No.	d × p	Nut ①				Nut ②				Common to ① and ②		Set Height L		Perpendicularity of the base (max)	Weight of 1 set (g)
		D ¹	B ¹	e ₁	b	D ²	D ²	B	e	S	T	(min)	(max)		
HLB-01	M12×1	22	6	2.5	3.5	22	17	6	2.7	3	2	9.5	10.5	0.05	17
HLB-02	M15×1	25	7	2.5	4.5	25	21	7	2.7	4	2	11.5	12.5	0.05	23
HLB-03	M17×1	28	7	2.5	4.5	28	24	7	2.7	4	2	11.5	12.5	0.05	29
HLB-04	M20×1	32	8	2.5	5.5	32	26	8	2.7	4	2	13.5	14.5	0.05	43
HLB-05	M25×1.5	38	10	4	6	38	32	10	4.2	5	2	16	17.5	0.05	72
HLB-06	M30×1.5	45	10	4	6	45	38	10	4.2	5	2	16	17.5	0.05	103
HLB-07	M35×1.5	52	11	4	7	52	44	11	4.2	5	2	18	19.5	0.05	150
HLB-08	M40×1.5	58	9	4	5	58	50	12	4.2	6	2.5	17	18.5	0.05	170
HLB-09	M45×1.5	65	10	4	6	65	56	13	4.2	6	2.5	19	20.5	0.05	240
HLB-10	M50×1.5	70	11	4	7	70	61	14	4.2	6	2.5	21	22.5	0.05	285
HLB-11	M55×2	75	11	5	6	75	67	15	5.2	7	3	21	23	0.07	310
HLB-12	M60×2	80	11	5	6	80	73	15	5.2	7	3	21	23	0.07	340
HLB-13	M65×2	85	12	5	7	85	79	12	5.2	7	3	19	21	0.07	330
HLB-14	M70×2	92	12	5	7	92	85	12	5.2	8	3.5	19	21	0.07	390
HLB-15	M75×2	98	13	5	8	98	90	13	5.2	8	3.5	21	23	0.07	480
HLB-16	M80×2	105	15	5	10	105	95	15	5.2	8	3.5	25	27	0.07	660
HLB-17	M85×2	110	16	5	11	110	102	16	5.2	8	3.5	27	29	0.07	760
HLB-18	M90×2	120	16	5	11	120	108	16	5.2	10	4	27	29	0.07	940
HLB-19	M95×2	125	17	5	12	125	113	17	5.2	10	4	29	31	0.07	1000
HLB-20	M100×2	130	18	5	13	130	120	18	5.2	10	4	31	33	0.07	1230
HLB-21	M105×2	140	18	6	12	140	126	18	6.5	12	5	30	32	0.1	1500
HLB-22	M110×2	145	19	6	13	145	133	19	6.5	12	5	32	34	0.1	1600
HLB-23	M115×2	150	19	6	13	150	137	19	6.5	12	5	32	34	0.1	1700
HLB-24	M120×2	155	20	7	13	155	138	20	7.5	12	5	33	35	0.1	1800
HLB-25	M125×2	160	21	7	14	160	148	21	7.5	12	5	35	37	0.1	1900
HLB-26	M130×2	165	21	7	14	165	149	21	7.5	12	5	35	37	0.1	2100
HLB-27	M135×2	175	22	7	15	175	160	22	7.5	14	6	37	39	0.1	2600
HLB-28	M140×2	180	22	7	15	180	160	22	7.5	14	6	37	39	0.1	2700
HLB-29	M145×2	190	24	8	16	190	171	24	8.5	14	6	40	43	0.1	3400
HLB-30	M150×2	195	24	8	16	195	171	24	8.5	14	6	40	43	0.1	3550
HLB-31	M155×3	200	25	8	17	200	182	25	8.5	16	7	42	45	0.1	3800
HLB-32	M160×3	210	25	8	17	210	182	25	8.5	16	7	42	45	0.1	4200
HLB-33	M165×3	210	26	9	17	210	193	26	9.5	16	7	43	46	0.1	4300
HLB-34	M170×3	220	26	9	17	220	193	26	9.5	16	7	43	46	0.1	4750
HLB-36	M180×3	230	27	9	18	230	203	27	9.5	18	8	45	48	0.1	5000
HLB-38	M190×3	240	28	9	18	240	214	28	9.5	18	8	46	49	0.1	5500
HLB-40	M200×3	250	29	9	19	250	226	29	9.5	18	8	48	51	0.1	6300

Hydraulic Nuts for Bearings

When larger bearings are mounted and dismantled, the work is considerably eased by using hydraulic nuts. See Fig.2 and Fig.3 in

case of mounting and Fig.4 and Fig.5 in case of dismantling.



1. Structure

with two hydraulic connection bores on OD and on end face

Hydraulic nuts consist of two basic components: an internally threaded steel cylinder (1) with a circular groove in one face, and an annular piston (2) which is inserted into the cylinder.

Two O-rings (3) between cylinder and piston serve as seals.

When oil is pumped into the pressure chamber (6), the force with which the piston is ejected is sufficient to mount or dismount bearings.

The hydraulic medium is oil and can be fed through two hydraulic connection bores G1/4(4) by a pressure source (e.g. a hand pump). The

connection bores are located on the end face and also on the OD. All hydraulic nuts are equipped with a nipple (5) for quick coupling to the oil supply; the threaded hole not being used is plugged by a closure nipple with ball, which is supplied with hydraulic nuts.

Unthreaded holes (8) are provided to take a drift of suitable length so that the screwing on of the nut is facilitated. Two of these holes are in the side faces and four around the circumference.

The nut should be carefully turned until it abuts the bearing and the piston is fully retracted into the cylinder.

And another unthreaded hole (9) is provided to take an indicator to measure the stroke of the piston.

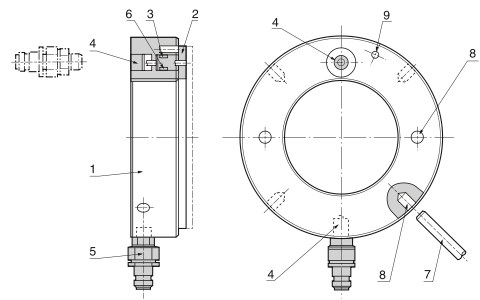

1: Cylinder 2: Piston 3: O-ring 4: Connecting bore G1/4 5: Nipple G1/4
6: Pressure chamber 7: Bar for rotating cylinder 8: Hole for bar
9: Hole for indicator to measure the stroke

Fig.1. Structure

2. Threads

Hydraulic nuts up to and including size 40 have metric ISO threads to tolerance 6H(ISO 965/III-1980) and the larger nuts from size 41 have metric ISO trapezoidal threads to tolerance 7H(ISO 2901-1977).

The mating thread on the shaft should be made to tolerance 6g(ISO 2901-1977) for the sizes and tolerance 7e(ISO 2901-1977) for the sizes with trapezoidal thread.

3. Material

The cylinders of nuts up to and including size 58 are made of hardened steel and the matching pistons are made of carbon chromium (bearing) steel. From size 60 the cylinders and pistons are made of construction steel.

4. Maintenance

If hydraulic nuts are not to be used for some time, they should be protected against corrosion. The holes for the oil supply leads should also be plugged.

If oil leaves the hydraulic nut when the piston is operated, this generally means that the seal is torn or damaged and must be replaced. To do this, the piston should be pressed out of the ring. To facilitate this operation, three auxiliary holes with closure nipples are provided in the full face of the cylinder. Using pins, which are supplied with the nut, the piston can be pushed out of the cylinder.

5. How to use

5.1 Mounting

(1) When mounting rolling bearings with a tapered bore on a tapered seating, adapter sleeve or withdrawal sleeve, the hydraulic nut is screwed on to a threaded section of the shaft or on to the sleeve thread until it abuts the bearing inner ring (Fig.2), or a special nut (Fig.3), or an end plate attached to the shaft end.

(2) The piston is in the initial position, i.e. it is fully retracted.

(3) A pump is used to inject pressurised oil into the nut. This displaces the piston axially and the bearing is pressed up on to the tapered seating. The permissible stroke (axial displacement) has been chosen to enable all bearings having bores with a taper of 1:12 or 1:30 to be mounted in a single operation.

(4) After mounting has been completed, the return valve of the pump should be opened so that the pressurised oil can leave the nut. To completely empty the oil, the piston must be returned to its original position. This is most easily accomplished by screwing the nut further up the shaft or sleeve thread.

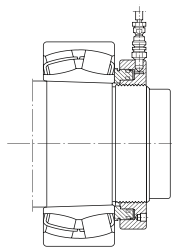

Fig.2. The threaded section of a shaft

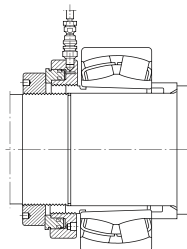

Fig.3. Sleeve thread

5.2 Dismounting

(1) When dismantling rolling bearings from withdrawal or adapter sleeves, the hydraulic nut is screwed on to the sleeve thread until it rests against the bearing inner ring (Fig.4), or a special nut, or against a special supporting ring (Fig.5).

(2) By displacing the piston, the sleeve will be withdrawn from the bearing bore, or the bearing will be pressed off the adapter sleeve.

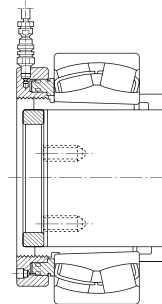

Fig.4. Sleeve thread

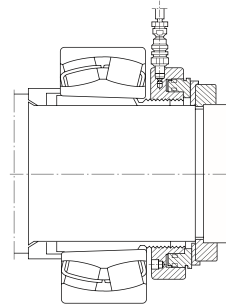

Fig.5. Sleeve thread and special supporting ring

6. Pumps

The pumps required to operate the hydraulic nuts should be suitable for pressures of 60 to 80 Mpa.

7. Pressure media

Normal machine oils having a viscosity of 300 mm²/s at the operating temperature are suitable pressure media. For mounting in the cold, less viscous oils should be used, e.g. oils for transformers.



Convenient HLB Locking Nuts for Bearings
Hydraulic Nuts A 5500 and A 5501 with metric thread and Plain bore

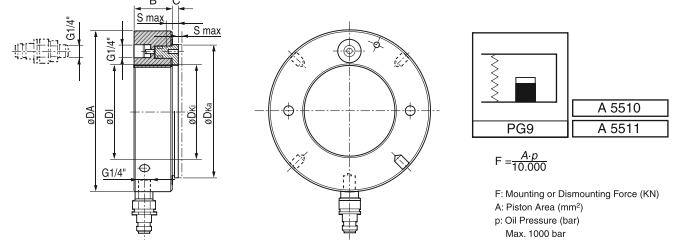

Thread D1 (mm)	Article No.		Plain Bore D (mm)	Article No. Bore	OD DA (mm)	Height S (mm)	Projecting Length C (mm)	Stroke Smax (mm)	Ring Piston (mm)		Piston Area A _p (mm ²)	Weight (Steel) C _a (kg)
	Right Hand	Left Hand							φD _a	φD _k		
TR 600 × 6	A 5501.2001	A 5501.2002	593.7	A 5501.2005	748	73	13	23	602	693	67.300	100
TR 630 × 6	A 5501.2601	A 5501.2602	623.7	A 5501.2605	782	74	14	23	632	726	72.900	110
TR 650 × 6	A 5501.3001	A 5501.3002	643.7	A 5501.3005	804	75	14	23	652	747	76.200	115
TR 670 × 6	A 5501.3401	A 5501.3402	663.7	A 5501.3405	826	76	14	24	672	768	79.500	120
TR 690 × 6	A 5501.3801	A 5501.3802	683.7	A 5501.3805	848	77	14	25	692	791	84.200	127
TR 710 × 7	A 5501.4201	A 5501.4202	702.7	A 5501.4205	870	78	15	25	712	812	87.700	135
TR 750 × 7	A 5501.5001	A 5501.5002	742.7	A 5501.5005	912	79	15	25	752	855	95.200	146
TR 800 × 7	A 5501.6001	A 5501.6002	792.7	A 5501.6005	965	80	16	25	802	908	103.900	161
TR 850 × 7	A 5501.7001	A 5501.7002	842.7	A 5501.7005	1020	83	16	26	852	962	114.600	181
TR 900 × 7	A 5501.8001	A 5501.8002	892.7	A 5501.8005	1075	86	17	30	902	1015	124.100	205
TR 950 × 8	A 5501.9001	A 5501.9002	941.7	A 5501.9005	1126	86	17	30	952	1069	135.700	218
TR 1000 × 8	A 5502.0001	A 5502.0002	991.7	A 5502.0005	1180	88	17	34	1002	1122	145.800	239

Thread D1 (mm)	Article No.		Plain Bore D (mm)	Article No. Bore	OD DA (mm)	Height S (mm)	Projecting Length C (mm)	Stroke Smax (mm)	Ring Piston (mm)		Piston Area A _p (mm ²)	Weight (Steel) C _a (kg)
	Right Hand	Left Hand							φD _a	φD _k		
M 50 × 1.5	A 5510.1001	A 5510.1002	46.7	A 5510.1005	114	38	4	5	50.5	104	2.900	2.70
M 55 × 2	A 5510.1101	A 5510.1102	51.1	A 5510.1105	120	38	4	5	55.5	109	3.150	2.75
M 60 × 2	A 5510.1201	A 5510.1202	56.1	A 5510.1205	125	38	5	5	60.5	115	3.300	2.80
M 65 × 2	A 5510.1301	A 5510.1302	61.1	A 5510.1305	130	38	5	5	65.5	121	3.600	3.00
M 70 × 2	A 5510.1401	A 5510.1402	66.1	A 5510.1405	135	38	5	5	70.5	127	3.800	3.20
M 75 × 2	A 5510.1501	A 5510.1502	71.1	A 5510.1505	140	38	5	5	75.5	132	4.000	3.40
M 80 × 2	A 5510.1601	A 5510.1602	76.1	A 5510.1605	146	38	5	5	80.5	137	4.200	3.70
M 85 × 2	A 5510.1701	A 5510.1702	81.1	A 5510.1705	150	38	5	5	85.5	142	4.400	3.75
M 90 × 2	A 5510.1801	A 5510.1802	86.1	A 5510.1805	156	38	5	5	90.5	147	4.700	4.00
M 95 × 2	A 5510.1901	A 5510.1902	91.1	A 5510.1905	162	38	5	5	95.5	153	4.900	4.30
M 100 × 2	A 5510.2001	A 5510.2002	96.1	A 5510.2005	166	38	6	5	100.5	158	5.100	4.40
M 105 × 2	A 5510.2101	A 5510.2102	101.1	A 5510.2105	172	38	6	5	105.5	163	5.300	4.65
M 110 × 2	A 5510.2201	A 5510.2202	106.1	A 5510.2205	178	38	6	5	110.5	169	5.600	4.95
M 115 × 2	A 5510.2301	A 5510.2302	111.1	A 5510.2305	182	38	6	5	115.5	174	5.800	5.00
M 120 × 2	A 5510.2401	A 5510.2402	116.1	A 5510.2405	188	38	6	5	120.5	179	6.000	5.25
M 125 × 2	A 5510.2501	A 5510.2502	121.1	A 5510.2505	192	38	6	5	125.5	184	6.200	5.35
M 130 × 2	A 5510.2601	A 5510.2602	126.1	A 5510.2605	198	38	6	5	130.5	190	6.400	5.65
M 135 × 2	A 5510.2701	A 5510.2702	131.1	A 5510.2705	204	38	6	5	135.5	195	6.600	5.90
M 140 × 2	A 5510.2801	A 5510.2802	136.1	A 5510.2805	208	38	7	5	140.5	200	6.800	6.00
M 145 × 2	A 5510.2901	A 5510.2902	141.1	A 5510.2905	214	39	7	5	145.5	206	7.300	6.50
M 150 × 2	A 5510.3001	A 5510.3002	146.1	A 5510.3005	220	39	7	5	150.5	211	7.500	6.60
M 155 × 3	A 5510.3101	A 5510.3102	149.8	A 5510.3105	226	39	7	5	155.5	218	8.100	6.95
M 160 × 3	A 5510.3201	A 5510.3202	154.8	A 5510.3205	232	40	7	6	160.5	224	8.600	7.60
M 165 × 3	A 5510.3301	A 5510.3302	159.8	A 5510.3305	238	40	7	6	165.5	229	8.900	7.90
M 170 × 3	A 5510.3401	A 5510.3402	164.8	A 5510.3405	244	41	7	6	170.5	235	9.400	8.40
M 180 × 3	A 5510.3601	A 5510.3602	174.8	A 5510.3605	256	41	7	6	180.5	247	10.300	9.15
M 190 × 3	A 5510.3801	A 5510.3802	184.8	A 5510.3805	270	42	8	7	191	259	11.500	10.5
M 200 × 3	A 5510.4001	A 5510.4002	194.8	A 5510.4005	282	43	8	8	201	271	12.500	11.5
TR 205 × 4	A 5510.4101	A 5510.4102	200.2	A 5510.4105	288	43	8	8	207	276	12.800	12.0
TR 210 × 4	A 5510.4201	A 5510.4202	205.2	A 5510.4205	294	44	8	9	212	282	13.400	12.5
TR 215 × 4	A 5510.4301	A 5510.4302	210.2	A 5500.4305	300	44	8	9	217	287	13.700	13.0
TR 220 × 4	A 5510.4401	A 5510.4402	215.2	A 5510.4405	306	44	8	9	222	293	14.400	13.5
TR 225 × 4	A 5510.4501	A 5510.4502	220.2	A 5510.4505	312	45	8	9	227	300	15.200	14.5
TR 230 × 4	A 5510.4601	A 5510.4602	225.2	A 5510.4605	318	45	8	9	232	305	15.500	14.5
TR 235 × 4	A 5510.4701	A 5510.4702	230.2	A 5510.4705	326	46	8	10	237	311	16.200	16.0
TR 240 × 4	A 5510.4801	A 5510.4802	235.2	A 5510.4805	330	46	9	10	242	316	16.500	16.0

Thread D1 (mm)	Article No.		Plain Bore D1 (mm)	Article No. Bore	OD D2 (mm)	Height S (mm)	Projecting Length C (mm)	Stroke Smax. (mm)	Ring Piston (mm)		Piston Area A _k (mm ²)	Weight (Steel) G _a (kg)
	Right Hand	Left Hand							φD _{1c}	φD _{2c}		
TR 250 × 4	A 5510.5001	A 5510.5002	245.2	A 5510.5005	342	46	9	10	252	329	17,600	17.5
TR 260 × 4	A 5510.5201	A 5510.5202	255.2	A 5510.5205	356	47	9	11	262	341	18,800	19.0
TR 270 × 4	A 5510.5401	A 5510.5402	265.2	A 5510.5405	368	48	9	12	272	352	19,800	20.5
TR 280 × 4	A 5510.5601	A 5510.5602	275.2	A 5510.5605	380	49	9	12	282	363	21,100	22.0
TR 290 × 4	A 5510.5801	A 5510.5802	285.2	A 5510.5805	390	49	9	13	292	375	22,400	22.5
TR 300 × 4	A 5510.6001	A 5510.6002	295.2	A 5510.6005	404	51	10	14	302	386	23,600	25.5
TR 310 × 5	A 5510.6201	A 5510.6202	304.7	A 5510.6205	416	52	10	14	312	397	24,900	27.0
TR 320 × 5	A 5510.6401	A 5510.6402	314.7	A 5510.6405	428	53	10	14	322	409	26,300	29.5
TR 330 × 5	A 5510.6601	A 5510.6602	324.7	A 5510.6605	438	53	10	14	332	419	27,000	30.0
TR 340 × 5	A 5510.6801	A 5510.6802	334.7	A 5510.6805	450	54	10	14	342	430	28,400	31.5
TR 345 × 5	A 5510.6901	A 5510.6902	339.7	A 5510.6905	456	54	10	14	347	436	29,400	32.5
TR 350 × 5	A 5510.7001	A 5510.7002	344.7	A 5510.7005	464	56	10	14	352	442	29,900	35.0
TR 360 × 5	A 5510.7201	A 5510.7202	354.7	A 5510.7205	472	56	10	15	362	455	31,300	35.5
TR 365 × 5	A 5510.7301	A 5510.7302	359.7	A 5510.7305	482	57	11	15	367	460	31,700	38.5
TR 370 × 5	A 5510.7401	A 5510.7402	364.7	A 5510.7405	486	57	11	16	372	466	32,800	39.0
TR 380 × 5	A 5510.7601	A 5510.7602	374.7	A 5510.7605	498	58	11	16	382	476	33,500	40.5
TR 385 × 5	A 5510.7701	A 5510.7702	379.7	A 5510.7705	504	58	11	16	387	483	34,700	41.0
TR 400 × 5	A 5510.8001	A 5510.8002	384.7	A 5510.8005	522	60	11	17	402	499	36,700	45.5
TR 410 × 5	A 5510.8201	A 5510.8202	404.7	A 5510.8205	534	61	11	17	412	510	38,300	48.0
TR 420 × 5	A 5510.8401	A 5510.8402	414.7	A 5510.8405	546	61	11	17	422	522	40,000	50.0
TR 430 × 5	A 5510.8601	A 5510.8602	424.7	A 5510.8605	556	62	11	17	432	532	40,800	52.5
TR 440 × 5	A 5510.8801	A 5510.8802	434.7	A 5510.8805	566	62	12	17	442	543	42,500	54.0
TR 450 × 5	A 5510.9001	A 5510.9002	444.7	A 5510.9005	580	64	12	17	452	554	44,100	57.5
TR 460 × 5	A 5510.9201	A 5510.9202	454.7	A 5510.9205	590	64	12	17	462	565	45,100	60
TR 470 × 5	A 5510.9401	A 5510.9402	464.7	A 5510.9405	602	65	12	18	472	576	46,900	62
TR 480 × 5	A 5500.9601	A 5500.9602	474.7	A 5500.9605	612	65	12	19	482	583	48,600	63
TR 490 × 5	A 5500.9801	A 5500.9802	484.7	A 5500.9805	624	66	12	19	492	573	49,500	66
TR 500 × 5	A 5501.0001	A 5501.0002	494.7	A 5501.0005	636	67	12	19	502	585	51,500	70
TR 510 × 6	A 5501.0201	A 5501.0202	503.7	A 5501.0205	648	68	12	20	512	595	53,300	74
TR 520 × 6	A 5501.0401	A 5501.0402	513.7	A 5501.0405	658	68	13	20	522	606	54,300	75
TR 530 × 6	A 5501.0601	A 5501.0602	523.7	A 5501.0605	670	69	13	21	532	617	56,200	79
TR 540 × 6	A 5501.0801	A 5501.0802	533.7	A 5501.0805	682	69	13	21	542	629	58,200	81
TR 550 × 6	A 5501.1001	A 5501.1002	543.7	A 5501.1005	693	70	13	21	552	639	59,200	84
TR 560 × 6	A 5501.1201	A 5501.1202	553.7	A 5501.1205	704	71	13	22	562	650	61,200	88
TR 570 × 6	A 5501.1401	A 5501.1402	563.7	A 5501.1405	716	72	13	23	572	661	63,200	91
TR 580 × 6	A 5501.1601	A 5501.1602	573.7	A 5501.1605	726	72	13	23	582	671	64,200	94

Thread D1 (mm)	Article No.		Plain Bore D1 (mm)	Article No. Bore	OD D2 (mm)	Height S (mm)	Projecting Length C (mm)	Stroke Smax. (mm)	Ring Piston (mm)		Piston Area A _k (mm ²)	Weight (Steel) G _a (kg)
	Right Hand	Left Hand							φD _{1c}	φD _{2c}		
TR 600 × 6	A 5501.2001	A 5501.2002	593.7	A 5501.2005	748	73	13	23	602	693	67,300	100
TR 630 × 6	A 5501.2601	A 5501.2602	623.7	A 5501.2605	782	74	14	23	632	726	72,900	110
TR 650 × 6	A 5501.3001	A 5501.3002	643.7	A 5501.3005	804	75	14	23	652	747	76,200	115
TR 670 × 6	A 5501.3401	A 5501.3402	663.7	A 5501.3405	826	76	14	24	672	768	79,500	120
TR 690 × 6	A 5501.3801	A 5501.3802	683.7	A 5501.3805	848	77	14	25	692	791	84,200	127
TR 710 × 7	A 5501.4201	A 5501.4202	702.7	A 5501.4205	870	78	15	25	712	812	87,700	135
TR 750 × 7	A 5501.5001	A 5501.5002	742.7	A 5501.5005	912	79	15	25	752	855	95,200	146
TR 800 × 7	A 5501.6001	A 5501.6002	792.7	A 5501.6005	965	80	16	25	802	908	103,900	161
TR 850 × 7	A 5501.7001	A 5501.7002	842.7	A 5501.7005	1020	83	16	26	852	962	114,600	181
TR 900 × 7	A 5501.8001	A 5501.8002	892.7	A 5501.8005	1075	86	17	30	902	1015	124,100	205
TR 950 × 8	A 5501.9001	A 5501.9002	941.7	A 5501.9005	1126	86	17	30	952	1069	135,700	218
TR 1000 × 8	A 5502.0001	A 5502.0002	991.7	A 5502.0005	1180	88	17	34	1002	1122	145,800	239

Convenient HLB Locking Nuts for Bearings
 Hydraulic Nuts A 5500 and A 5501 with imperial screw thread (UN or ACME thread form)

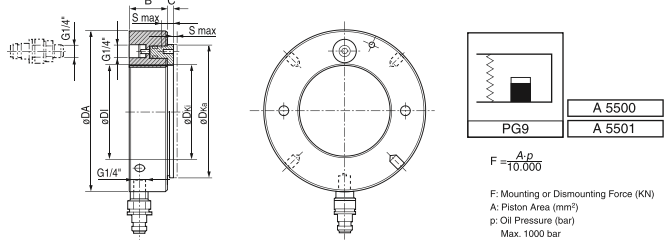

Thread DI (*)	Article No.		OD DA (mm)	Height B (mm)	Projecting Length C (mm)	Stroke Smax. (mm)	Ring Piston (mm)		Piston Area A _p (mm ²)	Weight (Steel) Ca. (kg)
	Right Hand	Left Hand					φD _{K1}	φD _{K2}		
UN 1.967-18TPI	A 5500.1003	A 5500.1004	114	38	4	5	50.5	85	2.900	2.70
UN 2.157-18TPI	A 5500.1103	A 5500.1104	120	38	4	5	55.5	90	3.150	2.75
UN 2.369-18TPI	A 5500.1203	A 5500.1204	125	38	5	5	60.5	95	3.300	2.80
UN 2.548-18TPI	A 5500.1303	A 5500.1304	130	38	5	5	65.5	101	3.600	3.00
UN 2.751-18TPI	A 5500.1403	A 5500.1404	135	38	5	5	70.5	107	3.800	3.25
UN 2.933-12TPI	A 5500.1503	A 5500.1504	140	38	5	5	75.5	112	4.000	3.40
UN 3.137-12TPI	A 5500.1603	A 5500.1604	146	38	5	5	80.5	117	4.200	3.75
UN 3.340-12TPI	A 5500.1703	A 5500.1704	150	38	5	5	85.5	122	4.400	3.80
UN 3.527-12TPI	A 5500.1803	A 5500.1804	156	38	5	5	90.5	127	4.700	4.00
UN 3.730-12TPI	A 5500.1903	A 5500.1904	162	38	5	5	95.5	133	4.900	4.30
UN 3.918-12TPI	A 5500.2003	A 5500.2004	166	38	6	5	100.5	138	5.100	4.40
UN 4.122-12TPI	A 5500.2103	A 5500.2104	172	38	6	5	105.5	143	5.300	4.70
UN 4.325-12TPI	A 5500.2203	A 5500.2204	178	38	6	5	110.5	149	5.600	4.95
UN 4.716-12TPI	A 5500.2403	A 5500.2404	188	38	6	5	120.5	159	6.000	5.25
UN 5.106-12TPI	A 5500.2603	A 5500.2604	198	38	6	5	130.5	170	6.400	5.65
UN 5.497-12TPI	A 5500.2803	A 5500.2804	208	38	7	5	140.5	180	6.800	6.00
UN 5.888-12TPI	A 5500.3003	A 5500.3004	220	39	7	5	150.5	191	7.500	6.60
UN 6.284-8TPI	A 5500.3203	A 5500.3204	232	40	7	6	160.5	204	8.600	7.60
UN 6.659-8TPI	A 5500.3403	A 5500.3404	244	41	7	6	170.5	215	9.400	8.40
UN 7.066-8TPI	A 5500.3603	A 5500.3604	256	41	7	6	180.5	227	10.300	9.15
UN 7.472-8TPI	A 5500.3803	A 5500.3804	270	42	8	7	191	239	11.500	10.5
UN 7.847-8TPI	A 5500.4003	A 5500.4004	282	43	8	8	201	251	12.500	11.5
UN 8.628-8TPI	A 5500.4403	A 5500.4404	306	44	8	9	222	273	14.400	13.5
UN 9.442-6TPI	A 5500.4803	A 5500.4804	330	46	9	10	242	296	16.500	16.0

Thread DI (*)	Article No.		OD DA (mm)	Height B (mm)	Projecting Length C (mm)	Stroke Smax. (mm)	Ring Piston (mm)		Piston Area A _p (mm ²)	Weight (Steel) Ca. (kg)
	Right Hand	Left Hand					φD _{K1}	φD _{K2}		
UN 10.192-6TPI	A 5500.5203	A 5500.5204	356	47	9	11	262	319	18.800	19.0
UN 11.004-6TPI	A 5500.5603	A 5500.5604	380	49	9	12	282	341	21.100	22.0
UN 11.785-6TPI	A 5500.6003	A 5500.6004	404	51	10	14	302	364	23.600	25.5
UN 12.562-6TPI	A 5500.6403	A 5500.6404	428	53	10	14	322	387	26.300	29.5
ACME 13.339-5TPI	A 5500.6803	A 5500.6804	450	54	10	14	342	408	28.400	31.5
ACME 14.170-5TPI	A 5500.7203	A 5500.7204	472	56	10	15	362	431	31.300	35.5
ACME 14.957-5TPI	A 5500.7603	A 5500.7604	498	58	11	16	382	452	33.500	40.5
ACME 15.745-5TPI	A 5500.8003	A 5500.8004	522	60	11	17	402	475	36.700	45.5
ACME 16.532-5TPI	A 5500.8403	A 5500.8404	546	61	11	17	422	498	40.000	50
ACME 17.319-5TPI	A 5500.8803	A 5500.8804	566	62	12	17	442	519	42.500	54
ACME 18.107-5TPI	A 5500.9203	A 5500.9204	590	64	12	17	462	541	45.100	60
ACME 18.894-5TPI	A 5500.9603	A 5500.9604	612	65	12	19	482	563	48.600	63
ACME 19.682-5TPI	A 5501.0003	A 5501.0004	636	67	12	19	502	585	51.500	70
ACME 20.867-4TPI	A 5501.0603	A 5501.0604	670	69	13	21	532	617	56.200	79
ACME 22.048-4TPI	A 5501.1203	A 5501.1204	704	71	13	22	562	650	61.200	88
ACME 23.623-4TPI	A 5501.2003	A 5501.2004	748	73	13	23	602	693	67.300	100
ACME 24.804-4TPI	A 5501.2603	A 5501.2604	782	74	14	23	632	726	72.900	110
ACME 26.379-4TPI	A 5501.3403	A 5501.3404	826	76	14	24	672	768	79.500	120
ACME 27.961-3TPI	A 5501.4203	A 5501.4204	870	78	15	25	712	812	87.700	135
ACME 29.536-3TPI	A 5501.5003	A 5501.5004	912	79	15	25	752	855	95.200	145
ACME 31.504-3TPI	A 5501.6003	A 5501.6004	965	80	16	25	802	908	103.900	160
ACME 33.473-3TPI	A 5501.7003	A 5501.7004	1020	83	16	26	852	962	114.600	180
ACME 35.441-3TPI	A 5501.8003	A 5501.8004	1075	86	17	30	902	1015	124.100	205
ACME 37.410-3TPI	A 5501.9003	A 5501.9004	1126	86	17	30	952	1069	135.700	220

■ Bearing Heater Ecological and High Functional Bearing Heater

● Use

When hydraulic tools or oil injection method cannot be used, the only alternative is often to heat the bearings or bearing rings before mounting or dismounting.

If heaters are correctly used they are excellent aids both for the occasional mounting or dismounting operation as well as for the regular requirements of line operation.

● Caution

Heating should always be done with care and it should be remembered that bearings should not be strongly heated and certainly not to temperatures above 120°C.

Greased and sealed bearings should generally not be heated.

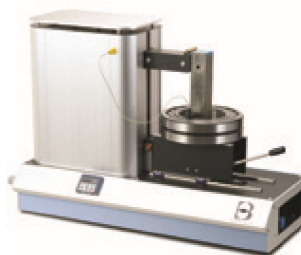

IHE0320, IHE0340
IHE0620, IHE0640



IHE0110
IHE0120

Inverter Driven Bearing Heater Standard Specifications

Items	detail items	1kVA100V	1kVA200V	3.3kVA	3.3kVA	6.6kVA	6.6kVA	11.8kVA	11.8kVA	23kVA	23kVA	
type		IHE0110	IHE0120	IHE0320	IHE0340	IHE0620	IHE0640	IHE1120	IHE1140	IHE2320	IHE2340	
Heating Capacity		1kVA	1kVA	3.3kVA	3.3kVA	6.6kVA	6.6kVA	11.8kVA	11.8kVA	23kVA	23kVA	
Applicable Bearing Size	Minimal bore diameter (mmφ)	20	20	35	35	35	35	50	50	50	50	
	Maximum outside diameter (mmφ)	200	200	300	300	350	350	600	600	800	800	
	Thickness (mm)	70	70	110	110	200	200	300	300	400	400	
	Weight (kg)	12	12	40	40	80	80	300	300	600	600	
Heating Bearing type	Can heat pre-greased bearing	Yes										
	Can heat sealed bearing	Yes										
Power Supply Characteristics	Phase	Single	Single	Three	Three	Three	Three	Three	Three	Three	Three	
	Voltage (V)	100-120V	200-240V	200-240V	380-480V	200-240V	380-480V	200-240V	380-480V	200-240V	380-480V	
	Frequency	50/60Hz	50/60Hz	50/60Hz	50/60Hz	50/60Hz	50/60Hz	50/60Hz	50/60Hz	50/60Hz	50/60Hz	
	Input Current (A) (maximum)	16.1A	9.7A	12.8A	7.5A	30.0A	16.1A	56.9A	29A	97A	49.6A	
Dimensions of body	H (mm)	347	347	510	510	660	660	1230	1230	1435	1435	
	D (mm)	175	175	305	305	385	385	700	700	850	850	
	W (mm)	573	573	750	750	920	920	1250	1250	1600	1600	
	Total weight (kg)	14	14	42	42	72	72	172	172	278	278	
Control Specifications	Temperature Control Mode	Range	0 ~ 250°C									
		temp. sensor type	K-type									
		Accuracy	1°C									
	Time Control Mode	Range	0-60min									
Accuracy		1s										
Power Reduction	By 10%	50-100%										
Demagnetization	Accuracy	300μT(3G)										
Operation Spec.	Operation	Operator with LEDs										
	Sequence Operation	Yes										
Temp. Display	Temp. Display	Celsius/Fahrenheit										
Environment specifications	Application site	Application site	Indoor (no corrosive gas,dust,etc)									
		Overvoltage Category	2	2	3	3	3	3	3	3	3	3
		Pollution Degree	2	2	2	2	2	2	2	2	2	2
	Ambient Operating Temp.		-10°C ~ 35°C									
Altitude		2000m max										
Ambient Operating Humidity		92% RH max										
I-type core	N-CI-1815	(bore diameter 20 ~ 35)	●	●								
	N-CI-1825	(bore diameter 35 ~ 50)	●	●								
	N-CI-1835	(bore diameter 50above)	●	●								
	N-CI-2525	(bore diameter 35 ~ 50)			●							
	N-CI-2535	(bore diameter 50 ~ 70)			●							
	N-CI-2545	(bore diameter 70above)			●							
	N-CI-3725	(bore diameter 35 ~ 50)				●	●					
	N-CI-3735	(bore diameter 50 ~ 80)				●	●					
	N-CI-3755	(bore diameter 80above)				●	●					
	N-CI-5235	(bore diameter 50 ~ 80)						●	●			
	N-CI-5255	(bore diameter 80 ~ 100)						●	●			
	N-CI-5270	(bore diameter 100above)						●	●			
N-CI-6735	(bore diameter 50 ~ 80)								●	●		
N-CI-6755	(bore diameter 80 ~ 130)								●	●		
N-CI-6785	(bore diameter 130above)								●	●		
temperature sensor	N-CTC-300	length 300mm	●	●								
	N-CTC-500	length 500mm			●	●	●					
	N-CTC-1000	length 1000mm						●	●	●	●	

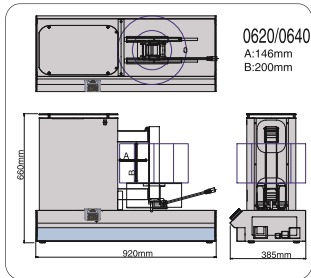
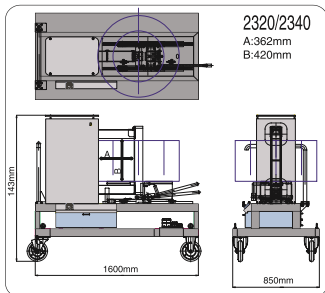
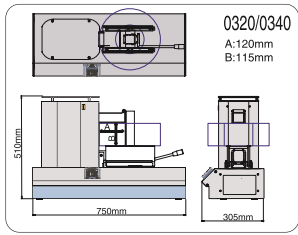
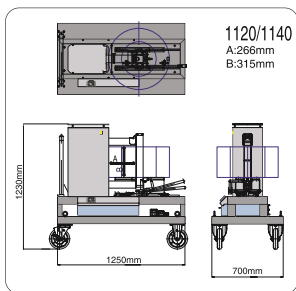
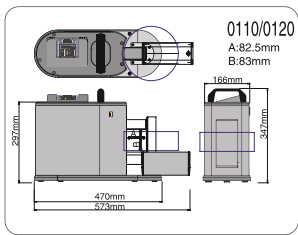

Three Features

Versatile and Wide Range Use	Induction Bearing Heater is designed mainly for heating up bearings. However, it can heat up bushings, gears, pulleys, couplings and other ring shaped objects.
Built-in Demagnetization Function	Induction Bearing Heater is all digitally controlled and demagnetizes bearings automatically after heating. Also, it can demagnetize bearings manually.
Temperature Control and Timer Control	Induction Bearing Heater has two control modes: Temperature Control Mode and Timer Control Mode. In Temperature Control Mode, Temperature can be set up to 250C as standard. Depending on region where it is used, temperature indication of Celsius can be changed to Fahrenheit and vice versa with Control Panel operation. Temperature retention function keeps bearing at the set temperature infinitely after it is reached until Stop is pressed. In Timer Control Mode, time can be set up to 60 minutes.

Three Advantages

Even Heating without Damage to Bearing	Use of direct flame or blow torch to heat up bearings is hazardous, risky, and causes uneven thermal expansion and/or material alteration. Induction Bearing Heater adopts electromagnetic induction principle to heat bearing(s) evenly to be thermally expanded without any damage to bearing(s). This feature eliminates unnecessary trouble to improve work efficiency.
Quick and Efficient Heating without Fire	Induction Bearing Heater has exciting coils embedded into a core as primary winding as in a transformer. AC current flowing in the coils induces a secondary current around the inner ring of bearing to generate heat necessary for its expansion due to bearing's own electrical resistance. This leads to little waste of energy (low energy loss) and quick heating of bearing (work) only. The induction Heating Method of non-use of fire accomplishes High Safety, Reliability and Work Efficiency for drastic shortening of the time necessary for Shrink Fit Process.
Clean Heating without Impurities Intruded	The shrink fit process using an oil bath requires extra time and cost for cleaning after fitting bearing(work) even though new oil is used. Induction Bearing Heater, without the use of oil, enables heating cleanly even a grease sealed bearing that will retain original pre-lubrication inside bearing. This leads to improvement of working environment because no oil storage management is required.

Slide type Bearing Installation Table

Once bearing and I-type core are installed in Slide Type Bearing Installation Table, all you have to do is to move the table to the heating position along the guide by pushing the lever. This device enables easy mounting and dismounting of even a hot and/or heavy bearing.

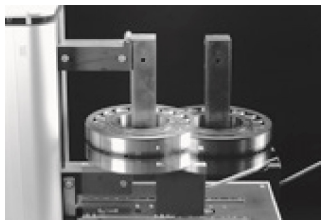
**Fault Tolerance**

In the case of heating unwittingly without installing the temperature sensor on the work (bearing) and in any other abnormal incident that should happen, Bearing Heater detects the fault(s) to stop heating automatically. In this manner, for Safe Operation of Bearing Heater, all possible measures conceivable are taken.

Operation Information Availability

Operation Panel is common to all types of ETOH's induction Bearing Heater and easy-to-use, user friendly, and can be operated instinctively at sight of the push-button symbols representing the individual elemental commands of Bearing Heater, as the result of our searching user's convenience. The external control signal inputs and outputs are equipped as standard and they allow Bearing Heater to be embedded into your FA system.

Small and Sensitive Temperature Sensor

Small and sensitive temperature sensor continuously monitors the bearing temperature to ensure precise detection of bearing (work) temperature even at high temperature rising rate as well as when the sensor is set in a confined small area.

Broad Range of Work Size

ETOH's induction Bearing Heater accommodates broad range of work (bearing) size by selecting I-type core suitable for the work inner ring diameter.

Optimal Heating with Accordance with Bearing (work) Applied

ETOH's induction Bearing Heater senses the electrical properties of the work (bearing) and the I-type core to heat the work (bearing) in the optimal condition. ETOH's induction Bearing Heater is featured to have convenient Power Reduction Function of setting the reduction rate 50%-100% by 10% for a delicate work (bearing) necessary to be heated amply and slowly.

Compatibility with a Wide Range of Various Voltage of Power Supply

ETOH's Induction Bearing Heater is compatible with a wide range of various voltages and various frequencies of power supplies around the globe. Stationary types of Bearing Heater are connected to 3-phase AC power Supply while portable types are connected to single phase AC power supply.

Appendix Table

inch—mm Conversion Table	Table 1
kgf—N Conversion Table	Table 2
kg—lb Conversion Table	Table 3
°C—°F Conversion Table	Table 4
Hardness Conversion Table	Table 5
Tolerance of Shaft	Table 6
Tolerance of Housing Bore	Table 7
International Units SI Conversion Table	Table 8
SI Prefixes	Table 9
Lubricating Greases	Table 10

Table 1. inch—mm Conversion Table

Fractions	inch Decimals	mm									
		0"	1"	2"	3"	4"	5"	6"	7"	8"	
0	.00000	0.0000	25.4000	50.8000	76.2000	101.6000	127.0000	152.4000	177.8000	203.2000	
1/64	.015625	0.3969	25.7969	51.1969	76.5969	101.9969	127.3969	152.7969	178.1969	203.5969	
1/32	.031250	0.7938	26.1938	51.5938	76.9938	102.3938	127.7938	153.1938	178.5938	203.9938	
3/64	.046875	1.1906	26.5906	51.9906	77.3906	102.7906	128.1906	153.5906	178.9906	204.3906	
1/16	.062500	1.5875	26.9875	52.3875	77.7875	103.1875	128.5875	153.9875	179.3875	204.7875	
5/64	.078125	1.9844	27.3844	52.7844	78.1844	103.5844	128.9844	154.3844	179.7844	205.1844	
3/32	.093750	2.3812	27.7812	53.1812	78.5812	103.9812	129.3812	154.7812	180.1812	205.5812	
7/64	.109375	2.7781	28.1781	53.5781	78.9781	104.3781	129.7781	155.1781	180.5781	205.9781	
1/8	.125000	3.1750	28.5750	53.9750	79.3750	104.7750	130.1750	155.5750	180.9750	206.3750	
9/64	.140625	3.5719	28.9719	54.3719	79.7719	105.1719	130.5719	155.9719	181.3719	206.7719	
5/32	.156250	3.9688	29.3688	54.7688	80.1688	105.5688	130.9688	156.3688	181.7688	207.1688	
11/64	.171875	4.3656	29.7656	55.1656	80.5656	105.9656	131.3656	156.7656	182.1656	207.5656	
3/16	.187500	4.7625	30.1625	55.5625	80.9625	106.3625	131.7625	157.1625	182.5625	207.9625	
13/64	.203125	5.1594	30.5594	55.9594	81.3594	106.7594	132.1594	157.5594	182.9594	208.3594	
7/32	.218750	5.5562	30.9562	56.3562	81.7562	107.1562	132.5562	157.9562	183.3562	208.7562	
15/64	.234375	5.9531	31.3531	56.7531	82.1531	107.5531	132.9531	158.3531	183.7531	209.1531	
1/4	.250000	6.3500	31.7500	57.1500	82.5500	107.9500	133.3500	158.7500	184.1500	209.5500	
17/64	.265625	6.7469	32.1469	57.5469	82.9469	108.3469	133.7469	159.1469	184.5469	209.9469	
9/32	.281250	7.1438	32.5438	57.9438	83.3438	108.7438	134.1438	159.5438	184.9438	210.3438	
19/64	.296875	7.5406	32.9406	58.3406	83.7406	109.1406	134.5406	159.9406	185.3406	210.7406	
5/16	.312500	7.9375	33.3375	58.7375	84.1375	109.5375	134.9375	160.3375	185.7375	211.1375	
21/64	.328125	8.3344	33.7344	59.1344	84.5344	109.9344	135.3344	160.7344	186.1344	211.5344	
11/32	.343750	8.7312	34.1312	59.5312	84.9312	110.3312	135.7312	161.1312	186.5312	211.9312	
23/64	.359375	9.1281	34.5281	59.9281	85.3281	110.7281	136.1281	161.5281	186.9281	212.3281	
3/8	.375000	9.5250	34.9250	60.3250	85.7250	111.1250	136.5250	161.9250	187.3250	212.7250	
25/64	.390625	9.9219	35.3219	60.7219	86.1219	111.5219	136.9219	162.3219	187.7219	213.1219	
13/32	.406250	10.3188	35.7188	61.1188	86.5188	111.9188	137.3188	162.7188	188.1188	213.5188	
27/64	.421875	10.7156	36.1156	61.5156	86.9156	112.3156	137.7156	163.1156	188.5156	213.9156	
7/16	.437500	11.1125	36.5125	61.9125	87.3125	112.7125	138.1125	163.5125	188.9125	214.3125	
29/64	.453125	11.5094	36.9094	62.3094	87.7094	113.1094	138.5094	163.9094	189.3094	214.7094	
15/32	.468750	11.9062	37.3062	62.7062	88.1062	113.5062	138.9062	164.3062	189.7062	215.1062	
31/64	.484375	12.3031	37.7031	63.1031	88.5031	113.9031	139.3031	164.7031	190.1031	215.5031	
1/2	.500000	12.7000	38.1000	63.5000	88.9000	114.3000	139.7000	165.1000	190.5000	215.9000	
33/64	.515625	13.0969	38.4969	63.8969	89.2969	114.6969	140.0969	165.4969	190.8969	216.2969	
17/32	.531250	13.4938	38.8938	64.2938	89.6938	115.0938	140.4938	165.8938	191.2938	216.6938	
35/64	.546875	13.8906	39.2906	64.6906	90.0906	115.4906	140.8906	166.2906	191.6906	217.0906	
9/16	.562500	14.2875	39.6875	65.0875	90.4875	115.8875	141.2875	166.6875	192.0875	217.4875	
37/64	.578125	14.6844	40.0844	65.4844	90.8844	116.2844	141.6844	167.0844	192.4844	217.8844	
19/32	.593750	15.0812	40.4812	65.8812	91.2812	116.6812	142.0812	167.4812	192.8812	218.2812	
39/64	.609375	15.4781	40.8781	66.2781	91.6781	117.0781	142.4781	167.8781	193.2781	218.6781	
5/8	.625000	15.8750	41.2750	66.6750	92.0750	117.4750	142.8750	168.2750	193.6750	219.0750	
41/64	.640625	16.2719	41.6719	67.0719	92.4719	117.8719	143.2719	168.6719	194.0719	219.4719	
21/32	.656250	16.6688	42.0688	67.4688	92.8688	118.2688	143.6688	169.0688	194.4688	219.8688	
43/64	.671875	17.0656	42.4656	67.8656	93.2656	118.6656	144.0656	169.4656	194.8656	220.2656	
11/16	.687500	17.4625	42.8625	68.2625	93.6625	119.0625	144.4625	169.8625	195.2625	220.6625	
45/64	.703125	17.8594	43.2594	68.6594	94.0594	119.4594	144.8594	170.2594	195.6594	221.0594	
23/32	.718750	18.2562	43.6562	69.0562	94.4562	119.8562	145.2562	170.6562	196.0562	221.4562	
47/64	.734375	18.6531	44.0531	69.4531	94.8531	120.2531	145.6531	171.0531	196.4531	221.8531	
3/4	.750000	19.0500	44.4500	69.8500	95.2500	120.6500	146.0500	171.4500	196.8500	222.2500	
49/64	.765625	19.4469	44.8469	70.2469	95.6469	121.0469	146.4469	171.8469	197.2469	222.6469	
25/32	.781250	19.8438	45.2438	70.6438	96.0438	121.4438	146.8438	172.2438	197.6438	223.0438	
51/64	.796875	20.2406	45.6406	71.0406	96.4406	121.8406	147.2406	172.6406	198.0406	223.4406	
13/16	.812500	20.6375	46.0375	71.4375	96.8375	122.2375	147.6375	173.0375	198.4375	223.8375	
53/64	.828125	21.0344	46.4344	71.8344	97.2344	122.6344	148.0344	173.4344	198.8344	224.2344	
27/32	.843750	21.4312	46.8312	72.2312	97.6312	123.0312	148.4312	173.8312	199.2312	224.6312	
55/64	.859375	21.8281	47.2281	72.6281	98.0281	123.4281	148.8281	174.2281	199.6281	225.0281	
7/8	.875000	22.2250	47.6250	73.0250	98.4250	123.8250	149.2250	174.6250	200.0250	225.4250	
57/64	.890625	22.6219	48.0219	73.4219	98.8219	124.2219	149.6219	175.0219	200.4219	225.8219	
29/32	.906250	23.0188	48.4188	73.8188	99.2188	124.6188	150.0188	175.4188	200.8188	226.2188	
59/64	.921875	23.4156	48.8156	74.2156	99.6156	125.0156	150.4156	175.8156	201.2156	226.6156	
15/16	.937500	23.8125	49.2125	74.6125	100.0125	125.4125	150.8125	176.2125	201.6125	227.0125	
61/64	.953125	24.2094	49.6094	75.0094	100.4094	125.8094	151.2094	176.6094	202.0094	227.4094	
31/32	.968750	24.6062	50.0062	75.4062	100.8062	126.2062	151.6062	177.0062	202.4062	227.8062	
63/64	.984375	25.0031	50.4031	75.8031	101.2031	126.6031	152.0031	177.4031	202.8031	228.2031	

Table 2. kgf—N Conversion Table

kgf	N	kgf	N	kgf	N	kgf	N
0.1020	1	9.8066	34	333.43	67	657.05	
0.2039	2	19.613	35	343.23	68	666.85	
0.3059	3	29.420	36	353.04	69	676.66	
0.4079	4	39.227	37	362.85	70	686.47	
0.5099	5	49.033	38	372.65	71	696.27	
0.6118	6	58.840	39	382.46	72	706.08	
0.7138	7	68.647	40	392.27	73	715.89	
0.8158	8	78.453	41	402.07	74	725.69	
0.9177	9	88.260	42	411.88	75	735.50	
1.0197	10	98.066	43	421.69	76	745.31	
1.1217	11	107.87	44	431.49	77	755.11	
1.2237	12	117.68	45	441.30	78	764.92	
1.3256	13	127.49	46	451.11	79	774.73	
1.4276	14	137.29	47	460.91	80	784.53	
1.5296	15	147.10	48	470.72	81	794.34	
1.6315	16	156.91	49	480.53	82	804.15	
1.7335	17	166.71	50	490.33	83	813.95	
1.8355	18	176.52	51	500.14	84	823.76	
1.9375	19	186.33	52	509.95	85	833.57	
2.0394	20	196.13	53	519.75	86	843.37	
2.1414	21	205.94	54	529.56	87	853.18	
2.2434	22	215.75	55	539.37	88	862.99	
2.3453	23	225.55	56	549.17	89	872.79	
2.4473	24	235.36	57	558.98	90	882.60	
2.5493	25	245.17	58	568.79	91	892.41	
2.6513	26	254.97	59	578.59	92	902.21	
2.7532	27	264.78	60	588.40	93	912.02	
2.8552	28	274.59	61	598.21	94	921.83	
2.9572	29	284.39	62	608.01	95	931.63	
3.0591	30	294.20	63	617.82	96	941.44	
3.1611	31	304.01	64	627.63	97	951.25	
3.2631	32	313.81	65	637.43	98	961.05	
3.3651	33	323.62	66	647.24	99	970.86	

1 kgf = 9.80665 N
1 N = 0.101972 kgf

How to convert: (1) When 10kgf should be converted into N, look for the number 10 on the central column in the first file.
The number at its right hand side shows 98.066N
(2) To the contrary, 10N can be converted into 1.0197kgf.

Table 3. kg—lb Conversion Table

kg	lb	kg	lb	kg	lb	kg	lb
0.454	1	2.205	34	74.957	67	147.71	
0.907	2	4.409	35	77.162	68	149.91	
1.361	3	6.614	36	79.366	69	152.12	
1.814	4	8.818	37	81.571	70	154.32	
2.268	5	11.023	38	83.776	71	156.53	
2.722	6	13.228	39	85.980	72	158.73	
3.175	7	15.432	40	88.185	73	160.94	
3.629	8	17.637	41	90.390	74	163.14	
4.082	9	19.842	42	92.594	75	165.35	
4.536	10	22.046	43	94.799	76	167.55	
4.990	11	24.251	44	97.003	77	169.76	
5.443	12	26.455	45	99.208	78	171.96	
5.897	13	28.660	46	101.41	79	174.17	
6.350	14	30.865	47	103.62	80	176.37	
6.804	15	33.069	48	105.82	81	178.57	
7.257	16	35.274	49	108.03	82	180.78	
7.711	17	37.479	50	110.23	83	182.98	
8.165	18	39.683	51	112.44	84	185.19	
8.618	19	41.888	52	114.64	85	187.39	
9.072	20	44.092	53	116.84	86	189.60	
9.525	21	46.297	54	119.05	87	191.80	
9.979	22	48.502	55	121.25	88	194.01	
10.433	23	50.706	56	123.46	89	196.21	
10.886	24	52.911	57	125.66	90	198.42	
11.340	25	55.116	58	127.87	91	200.62	
11.793	26	57.320	59	130.07	92	202.83	
12.247	27	59.525	60	132.28	93	205.03	
12.701	28	61.729	61	134.48	94	207.23	
13.154	29	63.934	62	136.69	95	209.44	
13.608	30	66.139	63	138.89	96	211.64	
14.061	31	68.343	64	141.10	97	213.85	
14.515	32	70.548	65	143.30	98	216.05	
14.968	33	72.753	66	145.51	99	218.26	

1 kg = 2.204622 lb
1 lb = 0.45359 kg

How to convert: (1) When 43kg should be converted into lb, look for the number 43 on the central column in the second file.
The number at its right hand side shows 94.799lb.
(2) To the contrary, 43lb can be converted into 19.504kg.

Table 4. °C—°F Conversion Table

$$C = \frac{5}{9}(F-32)$$

$$F = \frac{9}{5}C+32$$

°C	°F	°C	°F	°C	°F	°C	°F	°C	°F		
-73	-100	-148	-1.7	29	84.2	17.8	64	147.2	37.2	99	210.2
-62	-80	-112	-1.1	30	86.0	18.3	65	149.0	37.8	100	212.0
-51	-60	-76	-0.6	31	87.8	18.9	66	150.8	40.6	105	221
-40	-40	-40	0	32	89.6	19.4	67	152.6	43	110	230
-29	-20	-4	0.6	33	91.4	20.0	68	154.4	49	120	248
-23.3	-10	14	1.1	34	93.2	20.6	69	156.2	54	130	266
-17.8	0	32	1.7	35	95.0	21.1	70	158.0	60	140	284
-17.2	1	33.8	2.2	36	96.8	21.7	71	159.8	66	150	302
-16.7	2	35.6	2.8	37	98.6	22.2	72	161.6	71	160	320
-16.1	3	37.4	3.3	38	100.4	22.8	73	163.4	77	170	338
-15.6	4	39.2	3.9	39	102.2	23.3	74	165.2	82	180	356
-15.0	5	41.0	4.4	40	104.0	23.9	75	167.0	88	190	374
-14.4	6	42.8	5.0	41	105.8	24.4	76	168.8	93	200	392
-13.9	7	44.6	5.6	42	107.6	25.0	77	170.6	121	250	482
-13.3	8	46.4	6.1	43	109.4	25.6	78	172.4	149	300	572
-12.8	9	48.2	6.7	44	111.2	26.1	79	174.2	177	350	662
-12.2	10	50.0	7.2	45	113.0	26.7	80	176.0	204	400	752
-11.7	11	51.8	7.8	46	114.8	27.2	81	177.8	232	450	842
-11.1	12	53.6	8.3	47	116.6	27.8	82	179.6	260	500	932
-10.6	13	55.4	8.9	48	118.4	28.3	83	181.4	288	550	1022
-10.0	14	57.2	9.4	49	120.2	28.9	84	183.2	316	600	1112
-9.4	15	59.0	10.0	50	122.0	29.4	85	185.0	343	650	1202
-8.9	16	60.8	10.6	51	123.8	30.0	86	186.8	371	700	1292
-8.3	17	62.6	11.1	52	125.6	30.6	87	188.6	399	750	1382
-7.8	18	64.4	11.7	53	127.4	31.1	88	190.4	427	800	1472
-7.2	19	66.2	12.2	54	129.2	31.7	89	192.2	454	850	1562
-6.7	20	68.0	12.8	55	131.0	32.2	90	194.0	482	900	1652
-6.1	21	69.8	13.3	56	132.8	32.8	91	195.8	510	950	1742
-5.6	22	71.6	13.9	57	134.6	33.3	92	197.6	538	1000	1832
-5.0	23	73.4	14.4	58	136.4	33.9	93	199.4	593	1100	2012
-4.4	24	75.2	15.0	59	138.2	34.4	94	201.2	649	1200	2192
-3.9	25	77.0	15.6	60	140.0	35.0	95	203.0	704	1300	2372
-3.3	26	78.8	16.1	61	141.8	35.6	96	204.8	760	1400	2552
-2.8	27	80.6	16.7	62	143.6	36.1	97	206.6	816	1500	2732
-2.2	28	82.4	17.2	63	145.4	36.7	98	208.4	871	1600	2912

How to convert: (1) When 43°C should be converted into °F, look for the number 43 on the central column in the second file. The number at its right hand side shows 109.4°F.
 (2) To the contrary, 43°F can be converted into 6.1°C.

Table 5. Hardness Conversion Table

Nearly conversion for Rockwell C scale of Steel

Rockwell C scale (1471N)	Vickers	Brinell		Rockwell		Shore
		Standard ball	Tungsten carbide ball	A scale (588.4N)	B scale (980.7N)	
68	940	—	—	85.6	—	97
67	900	—	—	85.0	—	95
66	865	—	—	84.5	—	92
65	832	—	(739)	83.9	—	91
64	800	—	(722)	83.4	—	88
63	772	—	(705)	82.8	—	87
62	746	—	(688)	82.3	—	85
61	720	—	(670)	81.8	—	83
60	697	—	(654)	81.2	—	81
59	674	—	(634)	80.7	—	80
58	653	—	615	80.1	—	78
57	633	—	595	79.6	—	76
56	613	—	577	79.0	—	75
55	595	—	560	78.5	—	74
54	577	—	543	78.0	—	72
53	560	—	525	77.4	—	71
52	544	(500)	512	76.8	—	69
51	528	(487)	496	76.3	—	68
50	513	(475)	481	75.9	—	67
49	498	(464)	468	75.2	—	66
48	484	451	455	74.7	—	64
47	471	442	443	74.1	—	63
46	458	432	432	73.6	—	62
45	446	421	421	73.1	—	60
44	434	409	409	72.5	—	58
43	423	400	400	72.0	—	57
42	412	390	390	71.5	—	56
41	402	381	381	70.9	—	55
40	392	371	371	70.4	—	54
39	382	362	362	69.9	—	52
38	372	353	353	69.4	—	51
37	363	344	344	68.9	—	50
36	354	336	336	68.4	(109.0)	49
35	345	327	327	67.9	(108.5)	48
34	336	319	319	67.4	(108.0)	47
33	327	311	311	66.8	(107.5)	46
32	318	301	301	66.3	(107.0)	44
31	310	294	294	65.8	(106.0)	43
30	302	286	286	65.3	(105.5)	42
29	294	279	279	64.7	(104.5)	41
28	286	271	271	64.3	(104.0)	41
27	279	264	264	63.8	(103.0)	40
26	272	258	258	63.3	(102.5)	38
25	266	253	253	62.8	(101.5)	38
24	260	247	247	62.4	(101.0)	37
23	254	243	243	62.0	100.0	36
22	248	237	237	61.5	99.0	35
21	243	231	231	61.0	98.5	35
20	238	226	226	60.5	97.8	34
(18)	230	219	219	—	96.7	33
(16)	222	212	212	—	95.5	32
(14)	213	203	203	—	93.9	31
(12)	204	194	194	—	92.3	29
(10)	196	187	187	—	90.7	28
(8)	188	179	179	—	89.5	27
(6)	180	171	171	—	87.1	26
(4)	173	165	165	—	85.5	25
(2)	166	158	158	—	83.5	24
(0)	160	152	152	—	81.7	24

Numbers with () are for reference.

Table 6. Tolerance of Shaft

Dimension (mm)		a13		c12		d6		e6		e13		f5		f6		g5		g6		h4		h5		h6		h7		h8		h9		h10		h11		h13		js4		Dimension (mm)	
Over	Incl.	High	Low	High	Low	High	Low	High	Low	High	Low	High	Low	High	Low	High	Low	High	Low	High	Low	High	Low	High	Low	High	Low	High	Low	High	Low	High	Low	High	Low	High	Low	Over	Incl.		
3	6	+	-	-	-	-	-	-	-	-	-	-	-	-	-	-	-	-	-	-	-	-	-	-	-	-	-	-	-	-	-	-	-	-	-	-	3	6			
6	10	+	-	-	-	-	-	-	-	-	-	-	-	-	-	-	-	-	-	-	-	-	-	-	-	-	-	-	-	-	-	-	-	-	-	-	6	10			
10	18	+	-	-	-	-	-	-	-	-	-	-	-	-	-	-	-	-	-	-	-	-	-	-	-	-	-	-	-	-	-	-	-	-	-	-	10	18			
18	30	+	-	-	-	-	-	-	-	-	-	-	-	-	-	-	-	-	-	-	-	-	-	-	-	-	-	-	-	-	-	-	-	-	-	-	18	30			
30	40	+	-	-	-	-	-	-	-	-	-	-	-	-	-	-	-	-	-	-	-	-	-	-	-	-	-	-	-	-	-	-	-	-	-	-	30	40			
40	50	+	-	-	-	-	-	-	-	-	-	-	-	-	-	-	-	-	-	-	-	-	-	-	-	-	-	-	-	-	-	-	-	-	-	-	40	50			
50	65	+	-	-	-	-	-	-	-	-	-	-	-	-	-	-	-	-	-	-	-	-	-	-	-	-	-	-	-	-	-	-	-	-	-	-	50	65			
65	80	+	-	-	-	-	-	-	-	-	-	-	-	-	-	-	-	-	-	-	-	-	-	-	-	-	-	-	-	-	-	-	-	-	-	-	65	80			
80	100	+	-	-	-	-	-	-	-	-	-	-	-	-	-	-	-	-	-	-	-	-	-	-	-	-	-	-	-	-	-	-	-	-	-	-	80	100			
100	120	+	-	-	-	-	-	-	-	-	-	-	-	-	-	-	-	-	-	-	-	-	-	-	-	-	-	-	-	-	-	-	-	-	-	-	100	120			
120	140	+	-	-	-	-	-	-	-	-	-	-	-	-	-	-	-	-	-	-	-	-	-	-	-	-	-	-	-	-	-	-	-	-	-	-	120	140			
140	160	+	-	-	-	-	-	-	-	-	-	-	-	-	-	-	-	-	-	-	-	-	-	-	-	-	-	-	-	-	-	-	-	-	-	-	140	160			
160	180	+	-	-	-	-	-	-	-	-	-	-	-	-	-	-	-	-	-	-	-	-	-	-	-	-	-	-	-	-	-	-	-	-	-	-	160	180			
180	200	+	-	-	-	-	-	-	-	-	-	-	-	-	-	-	-	-	-	-	-	-	-	-	-	-	-	-	-	-	-	-	-	-	-	-	180	200			
200	225	+	-	-	-	-	-	-	-	-	-	-	-	-	-	-	-	-	-	-	-	-	-	-	-	-	-	-	-	-	-	-	-	-	-	-	200	225			
225	250	+	-	-	-	-	-	-	-	-	-	-	-	-	-	-	-	-	-	-	-	-	-	-	-	-	-	-	-	-	-	-	-	-	-	-	225	250			
250	280	+	-	-	-	-	-	-	-	-	-	-	-	-	-	-	-	-	-	-	-	-	-	-	-	-	-	-	-	-	-	-	-	-	-	-	250	280			
280	315	+	-	-	-	-	-	-	-	-	-	-	-	-	-	-	-	-	-	-	-	-	-	-	-	-	-	-	-	-	-	-	-	-	-	-	280	315			
315	355	+	-	-	-	-	-	-	-	-	-	-	-	-	-	-	-	-	-	-	-	-	-	-	-	-	-	-	-	-	-	-	-	-	-	-	315	355			
355	400	+	-	-	-	-	-	-	-	-	-	-	-	-	-	-	-	-	-	-	-	-	-	-	-	-	-	-	-	-	-	-	-	-	-	-	355	400			
400	450	+	-	-	-	-	-	-	-	-	-	-	-	-	-	-	-	-	-	-	-	-	-	-	-	-	-	-	-	-	-	-	-	-	-	-	400	450			
450	500	+	-	-	-	-	-	-	-	-	-	-	-	-	-	-	-	-	-	-	-	-	-	-	-	-	-	-	-	-	-	-	-	-	-	-	450	500			
500	560	+	-	-	-	-	-	-	-	-	-	-	-	-	-	-	-	-	-	-	-	-	-	-	-	-	-	-	-	-	-	-	-	-	-	-	500	560			
560	630	+	-	-	-	-	-	-	-	-	-	-	-	-	-	-	-	-	-	-	-	-	-	-	-	-	-	-	-	-	-	-	-	-	-	-	560	630			
630	710	+	-	-	-	-	-	-	-	-	-	-	-	-	-	-	-	-	-	-	-	-	-	-	-	-	-	-	-	-	-	-	-	-	-	-	630	710			
710	800	+	-	-	-	-	-	-	-	-	-	-	-	-	-	-	-	-	-	-	-	-	-	-	-	-	-	-	-	-	-	-	-	-	-	-	710	800			
800	900	+	-	-	-	-	-	-	-	-	-	-	-	-	-	-	-	-	-	-	-	-	-	-	-	-	-	-	-	-	-	-	-	-	-	-	800	900			
900	1000	+	-	-	-	-	-	-	-	-	-	-	-	-	-	-	-	-	-	-	-	-	-	-	-	-	-	-	-	-	-	-	-	-	-	-	900	1000			
1000	1120	+	-	-	-	-	-	-	-	-	-	-	-	-	-	-	-	-	-	-	-	-	-	-	-	-	-	-	-	-	-	-	-	-	-	-	1000	1120			
1120	1250	+	-	-	-	-	-	-	-	-	-	-	-	-	-	-	-	-	-	-	-	-	-	-	-	-	-	-	-	-	-	-	-	-	-	-	1120	1250			
1250	1400	+	-	-	-	-	-	-	-	-	-	-	-	-	-	-	-	-	-	-	-	-	-	-	-	-	-	-	-	-	-	-	-	-	-	-	1250	1400			
1400	1600	+	-	-	-	-	-	-	-	-	-	-	-	-	-	-	-	-	-	-	-	-	-	-	-	-	-	-	-	-	-	-	-	-	-	-	1400	1600			

Dimension (mm)		js5		js5		j6		js6		j7		k4		k5		k6		m5		m6		n5		n6		p5		p6		r6		r7		Base Tolerance				Dimension (mm)	
Over	Incl.	High	Low	High	Low	High	Low	High	Low	High	Low	High	Low	High	Low	High	Low	High	Low	High	Low	High	Low	High	Low	High	Low	High	Low	High	Low	IT2	IT3	IT5	IT7	Over	Incl.		
3	6	+	-	+	-	+	-	+	-	+	-	+	-	+	-	+	-	+	-	+12	+4	+13	+8	+16	+8	+17	+12	+20	+12	+23	+15	+27	+15	1.5	2.5	5	12	3	6
6	10	+	-	+	-	+	-	+	-	+	-	+	-	+	-	+	-	+	-	+15	+6	+16	+10	+19	+10	+21	+15	+24	+15	+28	+19	+34	+19	1.5	2.5	6	15	6	10
10	18	+	-	+	-	+	-	+	-	+	-	+	-	+	-	+	-	+	-	+18	+7	+20	+12	+23	+12	+26	+18	+29	+18	+34	+23	+41	+23	2	3	8	18	10	18
18	30	+	-	+	-	+	-	+	-	+	-	+	-	+	-	+	-	+	-	+21	+8	+24	+15	+28	+15	+31	+22	+35	+22	+41	+28	+49	+28	2.5	4	9	21	18	30
30	40	+	-	+	-	+	-	+	-	+	-	+	-	+	-	+	-	+	-	+25	+9	+28	+17	+33	+17	+37	+26	+42	+26	+50	+34	+59	+34	2.5	4	11	25	30	40
40	50	+	-	+	-	+	-	+	-	+	-	+	-	+	-	+	-	+	-	+30	+11	+33	+20	+39	+20	+45	+32	+51	+32	+60	+41	+71	+41	3	5	13	30	50	60
50	65	+	-	+	-	+	-	+	-	+	-	+	-	+	-	+	-	+	-	+35	+13	+38	+23	+45	+23	+52	+37	+59	+37	+73	+51	+86	+51	4	6	15	35	80	100
65	80	+	-	+	-	+	-	+	-	+	-	+	-	+	-	+	-	+	-	+40	+15	+45	+27	+52	+27	+61	+43	+68	+43	+90	+65	+105	+65	5	8	18	40	140	160
80	100	+	-	+	-	+	-	+	-	+	-	+	-	+	-	+	-	+	-	+46	+17	+51	+31	+60	+31	+70	+50	+79	+50	+106	+77	+123	+77	7	10	20	46	180	200
100	120	+	-	+	-	+	-	+	-	+	-	+	-	+	-	+	-	+	-	+52	+20	+57	+34	+66	+34	+79	+56	+88	+56	+126	+94	+146	+94	8	12	23	52	250	280
120	140	+	-	+	-	+	-	+	-	+	-	+	-	+	-	+	-	+	-	+57	+21	+62	+37	+73	+37	+87	+62	+98	+62	+144	+108	+165	+108	9	13	25	57	315	355
140	160	+	-	+	-	+	-	+	-	+	-	+	-	+	-	+	-	+	-	+63	+23	+67	+40	+80	+40	+95	+68	+108	+68	+166	+126	+189	+126	10	15	27	63	400	450
160	180	+	-	+	-	+	-	+	-	+	-	+	-	+	-	+	-	+	-	+70	+26	-	-	+88	+44	-	-	+122	+78	+194	+150	+220	+150	10	15	27	70	500	560
180	200	+	-	+	-	+	-	+	-	+	-	+	-	+	-	+	-	+	-	+80	+30	-	-	+100	+50	-	-	+138	+88	+225	+175	+255	+175	-	-	-	80	630	710
200	225	+	-	+	-	+	-	+	-	+	-	+	-	+	-	+	-	+	-	+90	+34	-	-	+112	+56	-	-	+156	+100	+276	+210	+300	+210	-	-	-	90	800	900
225	250	+	-	+	-	+	-	+	-	+	-	+	-	+	-	+	-	+	-	+106	+40	-	-	+132	+66	-	-	+186	+120	+316	+250	+355	+250	-	-	-	106	1000	1120
250	280	+	-	+	-	+	-	+	-	+	-	+	-	+	-	+	-	+	-	+126	+48	-	-	+156	+78	-	-	+218	+140	+408	+330	+455	+330	-	-	-	126	1250	

Table 7. Tolerance of Housing Bore

Table with 26 columns for dimensions E7 through K5 and 2 columns for Over/Incl. Tolerances are listed in micrometers (µm) for various bore sizes from 3mm to 1800mm.

Table with 13 columns for dimensions K6 through R7 and 2 columns for Over/Incl. Tolerances are listed in micrometers (µm) for various bore sizes from 3mm to 1800mm.

Table 8. International Units SI Conversion Table

Category	Name of unit	Symbol	Conversion to SI	SI name of unit	SI abbreviation
Angle	Degree	°	$\pi/180$	Radian	rad
	Minute	'	$\pi/10800$		
	Second	"	$\pi/648000$		
Length	Meter	m	1	Meter	m
	Micron	μ	10^{-6}		
	Angstrom	Å	10^{-10}		
	Nautical mile	mile	1852		
Area	Square meter	m ²	1	Square meter	m ²
	Radius	a	10^2		
	Hectare	ha	10^4		
Volume	Cubic meter	m ³	1	Cubic meter	m ³
	Liter	ℓ	10^{-3}		
Mass	Kilogram	kg	1	Kilogram	kg
	Ton	t	10^3		
	Atomic mass unit	u	1.66057×10^{-27}		
Time	Second	s	1	Second	s
	Minute	min	60		
	Hour	h	3600		
	Day	d	86400		
Speed	Meter per second	m/s	1	Meter per second	m/s
	Knot	kn	1852/3600		
Frequency and oscillation	Cycle	s ⁻¹	1	Hertz	Hz
Speed of rotation	revolution per minute	min ⁻¹	1/60	per second	s ⁻¹
Angular speed	Radial per second	rad/s	1	Radian per second	rad/s
Acceleration	Meters per second squared	m/s ²	1	Meters per second squared	m/s ²
	Gravity	G	9.80665		
Force	Kilogram force	kgf	9.80665	Newton	N
	Ton force	tf	9806.65		
	Dyne	dyn	10^{-5}		
Moment of force	Kilogram force meter	kgf·m	9.80665	Newton meter	N·m
Stress and pressure	Kilogram force per meter squared	kgf/m ²	9.80665	Pascal	Pa
	Kilogram force per centimeter squared	kgf/cm ²	9.80665×10^4		
	Kilogram force millimeter squared	kgf/mm ²	9.80665×10^6		

Category	Name of unit	Symbol	Conversion to SI	SI name of unit	SI abbreviation
Pressure	Meter of water	mH ₂ O	9806.65	Pascal	Pa
	Millimeter of mercury	mmHg	101325/760		
	Torr	Torr	101325/760		
	Atmosphere	atm	101325		
	Bar	bar	10^5		
Energy	Erg	erg	10^{-7}	Joule	J
	I. T. Calorie	cal _{I.T.}	4.1868		
	Kilogram force meter	kgf·m	9.80665		
	Kilowatt hour	kw·h	3.600×10^6		
	Metric horsepower hour	PS·h	2.64779×10^6		
Electron volt	eV	1.60219×10^{-19}			
Power and dynamic force	Watt	W	1	Watt	W
	Horsepower	PS	≈ 735.5		
	Kilogram force meter per second	kgf·m/s	9.80665		
Viscosity	Poise	P	10^{-1}	Pascal second	Pa·s
	Centipoise	cP	10^{-3}		
	Kilogram force per square meter	kgf·s/m ²	9.80665		
Kinematic viscosity	Stoke	St	10^{-4}	Square meter per second	m ² /s
	Centistoke	cSt	10^{-6}		

Table 9. SI Prefixes

Factor	Prefix		Factor	Prefix	
	Name	Symbol		Name	Symbol
10 ¹⁸	Exa	E	10 ⁻¹	Deci	d
10 ¹⁵	Peta	P	10 ⁻²	Centi	c
10 ¹²	Tera	T	10 ⁻³	Milli	m
10 ⁹	Giga	G	10 ⁻⁶	Micro	μ
10 ⁶	Mega	M	10 ⁻⁹	Nano	n
10 ³	Kilo	k	10 ⁻¹²	Pico	p
10 ²	Hecto	h	10 ⁻¹⁵	Femto	f
10	Deca	da	10 ⁻¹⁸	Atto	a

■ Table 10. Lubricating Greases

Typical Lubricating Greases for Bearings

Name of Grease	Grease Maker	Base Oil	Thickener	Penetration	Dropping point (°C)	Operating temperature range (°C)	Color	Properties				
								Water Resistance	High Speed Rotation	Noise	Grease Life at High Temp.	Torque at Low Temp.
Daphne Eponech No. 2	Idemitsu Kosan	Hydrodesulfurized wax	Lithium	280	197	-40~130	Tan	○				
Beacon 325	Exxon Mobil	Diester Oil	Lithium	280	193	-54~120	Light Gray	○	○			○
Polyrex EM	Exxon Mobil	Mineral Oil	Polyurea	285	300	-20~180	Blue	○	○		○	
Mobilgrease 28	Exxon Mobil	Diester Oil+Mineral Oil+Synthetic Hydrocarbon	Microgel	270	270	-62~177	Red	○			○	
Mobilux 2	Exxon Mobil	Mineral Oil	Lithium	270	178	0~125	Brown	○				
Temprex N3	Exxon Mobil	Mineral Oil	Lithium Complex	235	300	-30~150	Green	○	○		○	
Barrierta IMI	NOK Kluber	Flourine	PTFE	280	None	-50~220	White	○	○		○	○
Isoflex NBU15	NOK Kluber	Diester+Mineral Oil	Barium Complex	280	250	-40~130	Beige	○	○			
Isoflex NCA15	NOK Kluber	Synthetic Ester Mineral Blend	Calcium Complex	280	180	-50~120	Beige	○	○			
Isoflex LDS18SA	NOK Kluber	Ester Oil	Lithium	280	190	-60~130	Yellow	○	○			○
NOXLUB BN2420P	NOK Kluber	PFPE Oil	Special Thickener	280	None	-35~220	White				○	
NOXLUB BN4020	NOK Kluber	PFPE Oil	Special Thickener	280	None	-35~260	White				○	
Stabrags NBU 8 EP	NOK Kluber	Mineral Oil	Barium Complex	280	220	-35~150	Beige					○
Multemp LRL3	Kyodo Yushi	Polyolester	Lithium	235	208	-50~150	Peach White	○		○	○	○
Multemp PS2	Kyodo Yushi	Diester Oil+Mineral Oil	Lithium	275	190	-55~130	White	○	○			
Multemp SRL	Kyodo Yushi	Tetraester	Lithium	245	191	-40~150	Light Yellow	○		○	○	○
Alvania Grease 2S	Shell	Mineral Oil	Lithium	276	185	-25~120	Tan	○		○		
Alvania Grease 3S	Shell	Mineral Oil	Lithium	240	185	-20~135	Tan	○		○	○	
AeroShell Grease 7	Shell	Diester Oil	Microgel	285	268	-73~150	Light Brown	○	○		○	○
Alvania EP Grease 2	Shell	Mineral Oil	Lithium	285	185	-15~110	Reddish Brown	○				
Retinax LX No.2	Shell	Mineral Oil	Lithium Complex	270	250	-15~150	Light Brown	○			○	○
SH44M (DC44M)	Dow Corning Toray	Silicone Oil	Lithium	260	210	-40~180	Brown	○			○	○
NIGACE WR-S	Nippon Grease	Synthetic Oil	Urea	240	290	-30~150	Light Yellow	○			○	

Remarks: 1. When the grease is used at temperature near the high or low end of the recommended operating temperature, please contact NACHI.
 2. Generally Ester oil may give damage to polyacrylic rubber or ABS resin. Please be careful, when you use grease with Ester base oil.
 3. Do not mix different type of greases.
 4. If sodium thickener grease is mixed with water, the grease become soft and may leak.

NACHI-FUJIKOSHI CORP.

<http://www.nachi.com>

Tokyo Head Office

Shiodome Sumitomo Bldg. 17F 1-9-2 Higashi-shinbashi, Minato-ku, Tokyo 105-0021, JAPAN
Tel: +81-(0)3-5568-5247 Fax: +81-(0)3-5568-5237

Toyama Head Office

1-1-1 Fujikoshi-Honmachi, Toyama 930-8511, JAPAN TEL: +81-(0)76-423-5111 Fax: +81-(0)76-493-5211

AMERICA

Sales

● **NACHI AMERICA INC. HEADQUARTERS**
715 Pushville Road, Greenwood, Indiana, 46143, U.S.A.
Tel: +1-317-530-1002 Fax: +1-317-530-1012
URL: <http://www.nachiamerica.com/>

WEST COAST BRANCH
12652 E. Alondra Blvd. Cerritos, California, 90703, U.S.A.
Tel: +1-562-802-0055 Fax: +1-562-802-2455

MIAMI BRANCH - LATIN AMERICA DIV.
2315 N.W. 107th Ave., Doral, Florida, 33172, U.S.A.
Tel: +1-305-591-0054/0059/2604 Fax: +1-305-591-3110

● **NACHI ROBOTIC SYSTEMS INC.**
42775 West 9 Mile Road Novi, Michigan, 48375, U.S.A.
Tel: +1-248-305-6545 Fax: +1-248-305-6542
URL: <http://www.nachirobotics.com/>

● **NACHI CANADA INC.**
89 Courtland Ave., Unit No.2, Concord, Ontario, L4K 3T4, CANADA
Tel: +1-905-660-0088 Fax: +1-905-660-1146
URL: <http://www.nachicanada.com/>

● **NACHI MEXICANA, S.A. DE C.V.**
Urbina No 54, Parque Industrial Naucalpan Naucalpan de Juarez, Estado de Mexico C.P. 53489, MEXICO
Tel: +52-55-3604-0832 / 0842 / 0881 Fax: +52-55-3604-0882

● **NACHI MEXICANA ENGINEERING CENTER**
1171A, Calle Julio Diaz Torre, Fracc. Ciudad Industrial, Aguascalientes, C.P. 20290, MEXICO
Tel & Fax: +52-449-971-1689

Manufacturing

● **NACHI TECHNOLOGY INC.**
713 Pushville Road, Greenwood, Indiana, 46143, U.S.A.
Tel: +1-317-535-5000 Fax: +1-317-535-8484
URL: <http://nachitech.com/>

● **NACHI TOOL AMERICA INC.**
717 Pushville Road, Greenwood, Indiana, 46143, U.S.A.
Tel: +1-317-535-0320 Fax: +1-317-535-0983

● **NACHI BRASIL LTDA.**
Avenida João XXIII, No.2330, Jardim São Pedro, Mogi das Cruzes, S.P., BRAZIL, CEP 08830-000
Tel: +55-11-4793-8800 Fax: +55-11-4793-8870
URL: <http://www.nachi.com.br/>

● **SAO PAULO BRANCH**
Av. Paulista, 453, Primeiro Andar, Conj. 11, 12, 13 e 14, Cerqueira Cesar, Sao Paulo - SP, CEP:01311-000, BRASIL
Tel: +55-11-3284-9844 Fax: +55-11-3284-1751

EUROPE

Sales

● **NACHI EUROPE GmbH**
Bischofstrasse 99, 47809, Krefeld, GERMANY
Tel: +49-(0)2151-65046-0 Fax: +49-(0)2151-65046-90
URL: <http://www.nachi.de/>

● **SOUTH GERMANY OFFICE**
Friedelsheimer Strasse 47, 74321, Bietigheim-Bissingen, GERMANY
Tel: +49-(0)7142-77418-0 Fax: +49-(0)7142-77418-20

● **SPAIN BRANCH**
P.I. EL MONTALVO III C/Segunda, 6, Portal 1-2º, Oficina 5 37188-Carbalosa de La Sagrada Salamanca- España
Tel: +34-(0)923-197-837 Fax: +34-(0)923-197-758

● **CZECH BRANCH**
Obchodni 132 251 01 Cestlice CZECH
Tel: +420-(0)255-734-000 Fax: +420-(0)255-734-001

● **U.K. BRANCH**
Karaman Ciftligi Mevkii, Agaoglu My Prestige, K:13, D:110, 34746, Atasehir, Istanbul, TURKEY
Tel: +44-(0)121-423-5000 Fax: +44-(0)121-421-7520

● **TURKEY OFFICE**
Unit 3, 92, Kettles Wood Drive Woodgate Business Park, BIRMINGHAM B32 3DB, U.K.
Tel: +44-(0)121-423-5000 Fax: +44-(0)121-421-7520

Manufacturing

● **NACHI CZECH s.r.o**
Prumyslova 2732, 440 01 Louny, CZECH
Tel: +420-415-930-930 Fax: +420-415-930-940

ASIA and OCEANIA

Sales

● **NACHI SINGAPORE PTE. LTD.**
No.2 Joo Koon Way, Jurong Town, Singapore 628943, SINGAPORE
Tel: +65-65587393 Fax: +65-65587371

● **VIETNAM REPRESENTATIVE OFFICE, HO CHI MINH**
4Fl., Yoco Bld., 41 Nguyen Thi Minh Khai St., Dist.1, Ho Chi Minh, VIETNAM
Tel: +84-8-3822-3919 Fax: +84-8-3822-3918

● **VIETNAM REPRESENTATIVE OFFICE, HANOI**
5B Fl., Noza Bld., 243 Cau Giay St., Cau Giay Dist., Hanoi, VIETNAM
Tel: +84-4-3767-8605 Fax: +84-4-3767-8604

● **FUJIKOSHI-NACHI (MALAYSIA) SDN. BHD.**
No.17, Jalan USJ 21/3, 47630 UEP Subang Jaya, Selangor Darul Ehsan, MALAYSIA
Tel: +60-(0)3-89247900 Fax: +60-(0)3-89235884

● **PT.NACHI INDONESIA**
TEMPO PAVILION I, 7FL
JL. HR Rasuna Said Kav. 10-11
Setiabudi Jakarta Selatan DKI Jakarta -12950, INDONESIA
Tel: +62-012-527-2841 Fax: +62-021-527-3029

● NACHI KG TECHNOLOGY INDIA PVT.

GURGAON HEAD OFFICE
Unit No.207, 2nd Floor, Sewa Corporate Park, MG Road, Ifico Chowk, Gurgaon 122001, Haryana, INDIA
Tel: +91-(0)12-4450-2900 Fax: +91-(0)12-4450-9210

● **BANGALORE OFFICE**
F-11 Asha Chamber, No2, Venkata Swami Raju Road, Kumara Park West, Bangalore-560020, INDIA
Tel: +91-(0)80-3820-8701 Fax: +91-(0)80-3820-8700

● **那智不二越 (上海) 贸易有限公司 NACHI (SHANGHAI) CO., LTD.**
11F Royal Wealth Center, No.7 Lane 98 Danba Road, Putuo District, Shanghai, 200062, CHINA
Tel: +86-(0)21-6915-2200 Fax: +86-(0)21-6915-5427
URL: <http://www.nachi-china.com.cn/>

● **重庆分公司 CHONGQING BRANCH**
C17-18/19 Hogding International Building, Jiangbei District, Chongqing 400020, CHINA
Tel: +86-(0)23-8816-1967 Fax: +86-(0)23-8816-1968

● **沈阳分公司 SHENYANG BRANCH**
Room304, No.1 Yuebin Street, Shenhe District, Shenyang 110000, CHINA
Tel: +86-(0)24-3120-2252 Fax: +86-(0)24-2250-5316

● **北京分公司 BEIJING BRANCH**
Room 903A, Kuntai International Mansion, Building J, Yi No.12 Chao Wai Street, Chao yang Distric, Beijing 100020, CHINA
Tel: +86-(0)10-5879-0181 Fax: +86-(0)10-5879-0182

● **广州分公司 GUANGZHOU BRANCH**
101, Building1, Science & Technology Park, NO.1 Kehui, kexue load, Luogang District, Guangzhou 510670, CHINA

● **NACHI-FUJIKOSHI CORP. TAIPEI REPRESENTATIVE OFFICE**
No.109, Kao Young North Rd, Lung-Tan Hsin, Tao-Yuan Hsien, TAIWAN
Tel: +886-(0)3-411-7776 Fax: +886-(0)3-471-8402

● **NACHI-FUJIKOSHI CORP. KOREA REPRESENTATIVE OFFICE**
3F A-Youn Digital Tower 314-37, Seongsu-dong 2-ga, Seongdong-gu, Seoul 133-120, KOREA
Tel: +82-(0)2-469-2254 Fax: +82-(0)2-469-2264

● **NACHI (AUSTRALIA) PTY. LTD.**
Unit 1, 23-29 South Street, Rydalmere, N.S.W. 2116, AUSTRALIA
Tel: +61-(0)2-9898-1511 Fax: +61-(0)2-9898-1678
URL: <http://www.nachi.com.au/>

Manufacturing

● **NACHI TECHNOLOGY (THAILAND) CO., LTD.**
5/5 M, 2, Rojana Industrial Estate Nongbua, Ban Khai, Rayong, 21120, THAILAND
Tel: +66-38-961-682 Fax: +66-38-961-683

BANGKOK SALES OFFICE

Unit 23/109(A), Fl.24th Sorachai Bldg., Sukhumvit 63 Road(Ekamai), Klongtonna, Wattana, Bangkok 10110, THAILAND
Tel: +66-2-714-0008 Fax: +66-2-714-0740

● **NACHI INDUSTRIES PTE. LTD.**
No.2 Joo Koon Way, Jurong Town, Singapore 628943, SINGAPORE
Tel: +65-68613944 Fax: +65-68611153
URL: <http://www.nachinip.com.sg/>

● **NACHI PILIPINAS INDUSTRIES, INC.**
1st Avenue, Manalac Compound, Sta. Maria Industrial Estate, Bagumbayan, Taguig, Metro Manila, PHILIPPINES
Tel: +63-(0)2-838-3620 Fax: +63-(0)2-838-3623

● **NACHI KG TECHNOLOGY INDIA PVT. NEEMRANA PLANT**
Plot No. SP-86, RIICO Industrial Area, Neemrana 301705, Distt. Alwar, Rajasthan, INDIA
Tel: +91-(0)14-9467-1300 Fax: +91-(0)14-9467-1310

● **NACHI MOTHERSON PRECISION LTD.**
179, Sector4, IMT Manesar, District Gurgaon-122 050, Haryana, INDIA
Tel: +91-124-4936-000 Fax: +91-124-4936-022

● **NACHI MOTHERSON TOOL TECHNOLOGY LTD.**
D-59-60, Sector-6, Noida-201301, Distt. G.B. Nagar, U.P. INDIA
Tel: +91-120-425-8372 Fax: +91-120-425-8374

● **那智不二越 (江苏) 精密机械有限公司 NACHI (JIANGSU) INDUSTRIES CO., LTD.**
39 Nanyuan Road, Economic and Technological Development Zone (south), Zhongjiagang, Jiangsu 215618, CHINA
Tel: +86-(0)512-3500-7616 Fax: +86-(0)512-3500-7615

● **东莞建越精密轴承有限公司 DONGGUAN NACHI C.Y. CORPORATION**
Dangyong Village, Hongmci Town Dongguan City, Guangdong, 523160, CHINA
Tel: +86-(0)769-8843-1300 Fax: +86-(0)769-8843-1330

● **上海不二越精密轴承有限公司 SHANGHAI NACHI BEARINGS CO., LTD**
Yitong Industry Zone 258, Fengmao Rd. Malu Town, Jiading, Shanghai, 201801, CHINA
Tel: +86-(0)21-6915-6200 Fax: +86-(0)21-6915-6202

● **耐振 (上海) 精密刀具有限公司 SHANGHAI NACHI SAW CO., LTD.**
1F, 5 Building, 33 Forward Road, Malu Town, Jiading, Shanghai 201818, CHINA

● **建越工業股份有限公司 NACHI C.Y. CORP.**
No.109, Kao Young North Rd, Lung-Tan Hsin, Tao-Yuan Hsien, TAIWAN
Tel: +886-(0)3-471-7651 Fax: +886-(0)3-471-8402

● **대성나찌 유압공업 (주) DAESUNG-NACHI HYDRAULICS CO., LTD.**
269-22, Yusan-Dong, Yangsan-Si, Gyeongsangnam 626-230, KOREA
Tel: +82-(0)55-371-9700 Fax: +82-(0)55-384-3270

The appearance and specifications may be changed without prior notice if required to improve performance. Every care has been taken to ensure the accuracy of the information contained in this catalog but no liability can be accepted for any errors or omissions.

ISO/TS16949 THE SCOPE OF REGISTRATION : **No. B2100E-4**
THE DESIGN / DEVELOPMENT AND MANUFACTURE OF BALL AND ROLLER BEARINGS FOR AUTOMOBILE Printed in Japan 2014.04.V-ABE-ABE

NACHI
NACHI-FUJIKOSHI CORP.

